

COPY NO. 7

U 2

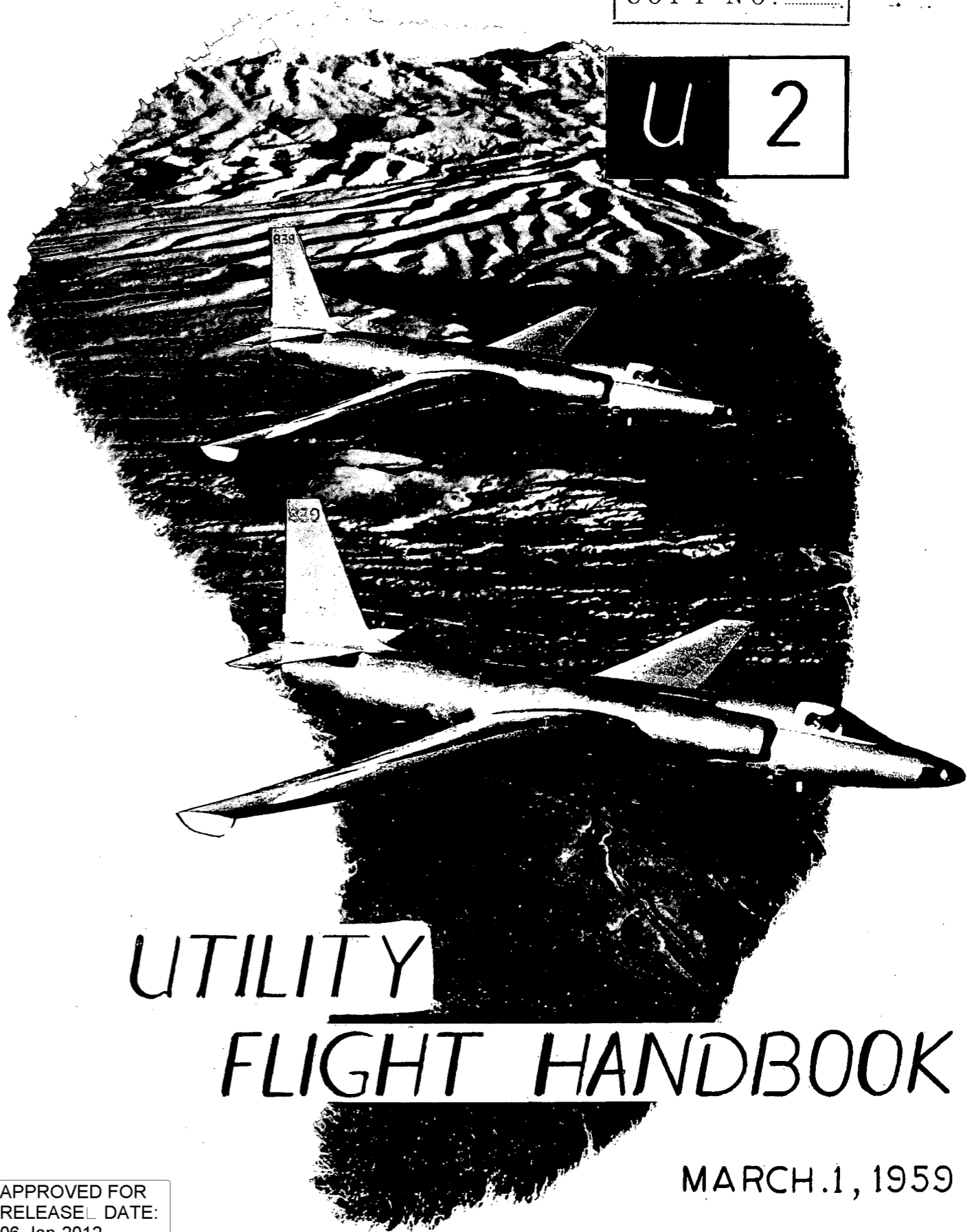

UTILITY
FLIGHT HANDBOOK

MARCH 1, 1959

APPROVED FOR
RELEASE DATE:
06-Jan-2012

TECHNICAL DATA CHANGE

TDC NO.

FM-9 PMM

AIRCRAFT DATA AFFECTED:

INSERT IN FRONT OF AFFECTED MANUAL.
*Denotes pages changed, added, or deleted by the current change.

FLIGHT MANUAL		MAINT. MANUAL		DOC. NO.	REF: S.B. / NONE
SECTION	*PAGE	SECTION	*PAGE		
2	2-20				

NATURE OF CHANGE: RAPID THROTTLE MOVEMENTS

THIS IS A FLIGHT SAFETY SUPPLEMENT

1. Add following after item 12, "BEFORE TAKE-OFF" check list:

CAUTION

Avoid rapid throttle "jockeying" at high power on the ground. Lack of ram air in inlet ducts under rapid transient power conditions can cause severe engine "burping" with resultant aircraft damage. Throttle bursts may be made if conditions demand but are neither required nor recommended for take-off.

2. Delete second sentence under "NORMAL TAKE-OFF" and substitute the following:

Minor chugging does no damage and does not slow acceleration time.

A-MODEL

TABLE OF CONTENTS

SECTION I	DESCRIPTION	1-1
SECTION II	NORMAL PROCEDURES	2-1
SECTION III	EMERGENCY PROCEDURES	3-1
SECTION IV	DESCRIPTION AND OPERATION OF AUXILIARY EQUIPMENT	4-1
SECTION V	OPERATING LIMITATIONS	5-1
SECTION VI	FLIGHT CHARACTERISTICS	6-1
SECTION VII	SYSTEMS OPERATION	7-1
SECTION IX	ALL WEATHER OPERATION	9-1
APPENDIX I	OPERATING DATA	A-1
INDEX		X-1

NOTE: The technical data information furnished herein is intended to be used as INTERIM data only. It will be replaced and superseded at the time of issue of the first change to the affected manual(s).

U-2

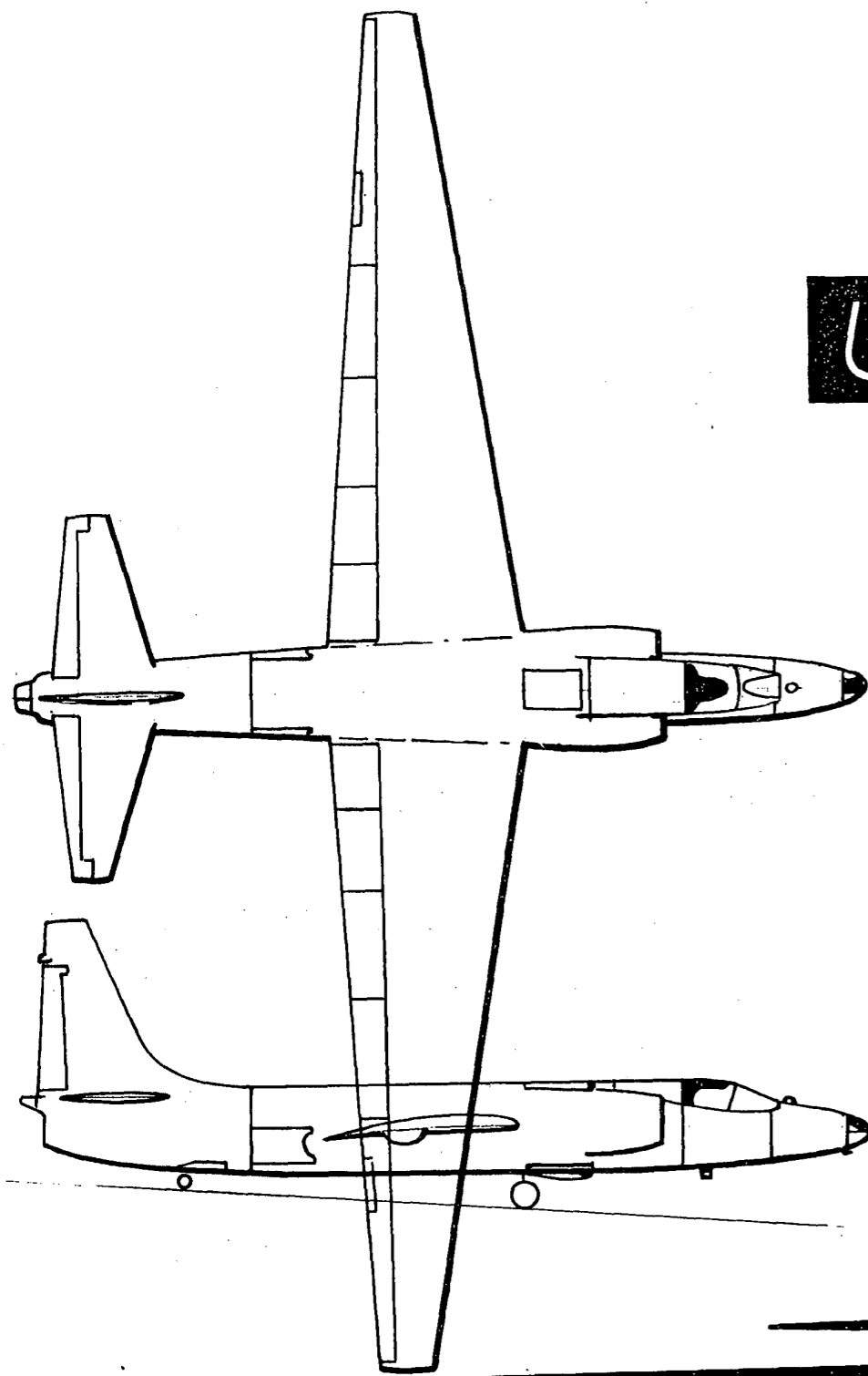

TECHNICAL DATA CHANGE

TDC NO.

FM-9 MM-

AIRCRAFT DATA AFFECTED:

INSERT IN FRONT OF AFFECTED MANUAL.
*Denotes pages changed, added, or deleted by the current change.

FLIGHT MANUAL		MAINT. MANUAL		DOC. NO.	REF: S.B./NONE
SECTION	*PAGE	SECTION	*PAGE		
2	2-20				

APPROVED: *[Signature]* 4-28-60

NATURE OF CHANGE: RAPID THROTTLE MOVEMENTS

THIS IS A FLIGHT SAFETY SUPPLEMENT

1. Add following after item 12, "BEFORE TAKE-OFF" check list:

CAUTION

Avoid rapid throttle "jockeying" at high power on the ground. Lack of ram air in inlet ducts under rapid transient power conditions can cause severe engine "burping" with resultant aircraft damage. Throttle bursts may be made if conditions demand but are neither required nor recommended for take-off.

2. Delete second sentence under "NORMAL TAKE-OFF" and substitute the following:

Minor chugging does no damage and does not slow acceleration time.

NOTE: The technical data information furnished herein is intended to be used as INTERIM data only. It will be replaced and superseded at the time of issue of the first change to the affected manual(s)

TECHNICAL DATA CHANGE

TDC NO.

FM- 3 MM-

AIRCRAFT DATA AFFECTED:

INSERT IN FRONT OF AFFECTED MANUAL.
*Denotes pages changed, added, or deleted by the current change.

FLIGHT MANUAL		MAINT. MANUAL		DOC. NO.
SECTION	*PAGE	SECTION	*PAGE	
4	4-8			REF: S.B./
	4-9			
	4-11			

NATURE OF CHANGE: REVISE "OXYGEN SYSTEM", AS NOTED.

Page 4-8 GENERAL:

Primary Reducer 83 ± 2 psi (was 82)
Secondary Reducer 60 ± 2 psi (was 68)
Lo-Press Lite (Red) 50 ± 3 psi (was 60 ± 2)

Delete Note on "Single Supply Oxygen System"

PRE-FLIGHT CHECK:

Para. 4 - 60 psi (was 68)

Page 4-9 NORMAL OPERATION

Para. 4 - 50 psi (was 60)

EMERG. OPERATION:

50 psi (was 60) - 3 places.

Page 4-11 EQUIPMENT SELECTION:

4th Paragraph - Delete last sentence and a, b & c.

Add - This may be remedied by use of 258-01 reducing valve and A2 259 adapter, between the seat pack and the oxygen mask.

APPROVED: 28 Aug 59 / G. C. Jullenson

APPROVED: 28 Aug 59 / G. C. Jullenson

NOTE: The technical data information furnished herein is intended to be used as INTERIM data only. It will be replaced and superseded at the time of issue of the first change to the affected manual(s)

TECHNICAL DATA CHANGE

TDC NO.

FM- 4 MM-

AIRCRAFT DATA AFFECTED:

INSERT IN FRONT OF AFFECTED MANUAL.
*Denotes pages changed, added, or deleted by the current change.

FLIGHT MANUAL		MAINT. MANUAL		DOC. NO.
SECTION	*PAGE	SECTION	*PAGE	
2	2-27			REF: S.B./

NATURE OF CHANGE: AIRCRAFT CONTROL

Add following paragraph after altitude-airspeed tabulation under "AIRCRAFT CONTROL".

The best cruise performance is obtained by flying the speed schedule as precisely as possible. If the speed is too fast the airplane will not climb at the proper rate. This can increase fuel consumption and decrease range. The optimum procedure is to establish the airspeed for the next highest altitude and allow the airplane to climb. When this altitude is reached, the speed should again be reduced to the value required for the next highest altitude. This can be accomplished by interpolating the speed schedule for altitude increments of 500 or 1000 feet. If the autopilot Mach sensor does not control the airspeed with reasonable accuracy the expected performance will not be realized. This should be reported for corrective action.

NOTE: The technical data information furnished herein is intended to be used as INTERIM data only. It will be replaced and superseded at the time of issue of the first change to the affected manual(s)

TECHNICAL DATA CHANGE

TDC NO.

FM- 5 MM-

**AIRCRAFT DATA
AFFECTED:**INSERT IN FRONT OF
AFFECTED MANUAL.*Denotes pages changed,
added, or deleted by the
current change.

FLIGHT MANUAL		MAINT. MANUAL		DOC. NO.
SECTION	*PAGE	SECTION	*PAGE	
APPENDIX I				REF: S.B./
4	A4-2			

NATURE OF CHANGE: CRUISE PERFORMANCE, P-31 ENGINE

Delete last paragraph under "CRUISE PERFORMANCE, P-31
ENGINE" and substitute the following:

Figure A4-3 shows the standard fuel variation with time. The curves show the flight time to zero totalizer reading. If additional time due to "manufactured" fuel was shown, the time would be increased by about 15-20 minutes maximum. These curves can be used during flight to keep a running check on fuel consumption. However, it must be emphasized that the fuel-time curve can vary from Figure A4-3 for a number of reasons, such as:

1. Fuel burned on ground prior to take-off.
2. Differences in engines.
3. Differences in airplane gross weight.
4. Variation of outside air temperature from standard.
5. Variations from the standard cruise airspeed schedule.

The ground fuel consumption prior to take-off is not included in Figure A4-3 because it can vary with different operational procedures. However, if possible, it should be minimized because the fuel reserve will be decreased for a mission of given duration. For example, if 25 gallons of fuel are burned prior to take-off, the fuel reserve will be decreased by about 20 gallons for an 8 hour mission under standard conditions. The range would be unchanged. However, if the mission requirements specify a given landing reserve, then range must be sacrificed if the ground fuel consumption is high. For a

NOTE: The technical data information furnished herein is intended to be used as INTERIM data only. It will be replaced and superseded at the time of issue of the first change to the affected manual(s)

TECHNICAL DATA CHANGE

TDC NO. FM-5 -REP 5B DOC. FLIGHT MANUAL

mission with full internal fuel and a specified 50 gallon landing reserve, 25 gallons burned on the ground can reduce the range about 75 miles.

The standard fuel-time curve is based on cruising at the altitudes shown in Figure A4-1. If the cruise altitude is low the fuel consumption will be increased. This can be caused by temperatures that are hotter than standard, improper cruise speeds or heavy airplane gross weight. If the cause is entirely due to temperature there is a negligible effect on range because the increased true airspeed compensates for the higher fuel consumption. However, heavy airplane gross weight or improper cruise speeds can cause a loss in range. The cruise climb procedures outlined in SECTION II should be followed for best performance.

TECHNICAL DATA CHANGE

TDC NO.

FM-2 > MM-

AIRCRAFT DATA AFFECTED:

INSERT IN FRONT OF AFFECTED MANUAL.
*Denotes pages changed, added, or deleted by the current change.

FLIGHT MANUAL		MAINT. MANUAL		DOC. NO.
SECTION	*PAGE	SECTION	*PAGE	
5	5-5			REF: S.B./407

NATURE OF CHANGE: WING FLAP EXTENTION AIRSPEED LIMITATIONS

Under the heading:

CONFIGURATION

MAX. ALLOWABLE AIRSPEED

GENERAL

DELETE the second sentence in its entirety.

SUBSTITUTE Wing Flaps Extended up to 25° 130 Knots
 Wing Flaps Extended over 25° 100 Knots

APPROVED: [Signature]

NOTE: The technical data information furnished herein is intended to be used as INTERIM data only. It will be replaced and superseded at the time of issue of the first change to the affected manual(s)

TECHNICAL DATA CHANGE

TDC NO.

FM-1 > MM-

AIRCRAFT DATA AFFECTED:

INSERT IN FRONT OF AFFECTED MANUAL.
*Denotes pages changed, added, or deleted by the current change.

FLIGHT MANUAL		MAINT. MANUAL		DOC. NO.
SECTION	*PAGE	SECTION	*PAGE	
IV	4-11			REF: S.B./399

NATURE OF CHANGE: USE OF A-13A MASK ADAPTER IN O₂ SYSTEM

Delete all text under "EQUIPMENT SELECTION" and substitute the following:

On all flights above 45,000 feet the pressure suit is mandatory.

An adapter to permit the use of an A-13A oxygen mask in lieu of the MA-2 helmet may be used for low altitude flight up to 45,000 feet, when use of the MA-2 helmet and the partial pressure suit is not desired.

WARNING

The MA-2 pressure helmet should not be worn without the suit as it requires tiedown provisions. Loss of cabin pressure can cause the helmet to rise dangerously high or it could be torn off during bailout causing loss of oxygen facilities.

Under normal operating conditions the output safety pressure from the seat pack is too great for use of an A-13A mask. Its use under such conditions is unsatisfactory resulting in garbled radio transmissions and breathing discomfort. Therefore, a reduction in outlet pressure from the seat pack to mask is required. This is accomplished by inserting a pressure reducer (mask adapter) in the outlet-end of the seat pack hose to reduce the outlet pressure by a ratio of approximately 2.8 to 1.

NOTE

A Lombard or P4 helmet should be used with the A-13A oxygen mask.

NOTE: The technical data information furnished herein is intended to be used as INTERIM data only. It will be replaced and superseded at the time of issue of the first change to the affected manual(s)

TECHNICAL DATA CHANGE

TDC NO.

COPY NO. 8

FM-7 MM-

AIRCRAFT DATA AFFECTED:

INSERT IN FRONT OF AFFECTED MANUAL.
*Denotes pages changed, added, or deleted by the current change.

FLIGHT MANUAL		MAINT. MANUAL		DOC. NO.
SECTION	*PAGE	SECTION	*PAGE	
II	2-8 2-9 2-10 2-11			REF. S.B.

NATURE OF CHANGE: Revision of Pilot Check Lists

Delete the sections "PRIOR TO BOARDING AIRCRAFT" and "PILOT EQUIPMENT CHECK" and substitute the following:

PRIOR TO BOARDING AIRCRAFT

When the pilot arrives at the aircraft, qualified personnel will be available to assist him in performing check lists up to engine start.

NOTE

In hot or extremely cold weather, every effort should be made to keep the pilot at a comfortably cool temperature prior to starting engines. If the pilot becomes too warm, he will perspire excessively; too cold a temperature results in pilot discomfort plus excessive face plate fogging.

1. Form 781 - Checked by pilot and Part 2 signed.
2. Shoulder straps and safety belt - Fully extended to facilitate pilot hook-up.
3. Relief bottle - Installed.
4. Seat blocks and back cushion - Installed as required.
5. Seat pack - Installed.

NOTE: The technical data information furnished herein is intended to be used as INTERIM data only. It will be replaced and superseded at the time of issue of the first change to the affected manual(s)

TECHNICAL DATA CHANGE

TDC NO. FM-7 REF ~~SB~~ DOC Flight Manual

PILOT EQUIPMENT CHECK (cont)

- A. 7. Breathing hose - Connect to suit breathing connection and install safety clip.
8. Amphenol plug - Connected and locked.
9. Green apple cable - Position under right lap belt and secure with strap and snap. (Only on unmodified seat packs).
10. Radio by pass cord - Under left lap belt.
11. Harness - Connect shoulder harness to lap belt.
12. F-1 release - Attach to lap belt and lock belt.
13. Low altitude escape lanyard - Hooked to parachute "D" ring.
14. Face heat - Attach emergency face heat cord to left side of faceplate; circuit breaker pulled.
15. Face plate - Recheck locked and secure.
16. Press-to-test - Check for oxygen leaks and for suit inflation in 7 seconds.
17. Auxiliary power - Connected and On.
18. Secondary oxygen valve - On.
19. Primary oxygen valve - Off. Check that "PRIM OFF" oxygen warning light illuminated. Check that low pressure oxygen gage reads approximately 60 \pm 2 psi.
20. Secondary oxygen valve - Turn Off momentarily and check that the "LOW PRESS" oxygen warning light is illuminated. Turn valve back On to restore oxygen flow to the pilot.
21. Primary oxygen valve - On. With both valves On, check that both oxygen warning lights are out and that the low pressure oxygen gage reads 83 \pm 2 psi.
22. Face heat - Check for face plate heat and advise pilot to check radio.
23. Oxygen - Recheck aircraft and emergency supply.

TECHNICAL DATA CHANGETDC NO. FM-7 ~~REF~~ ~~SB~~ DOC Flight ManualPILOT EQUIPMENT CHECK (cont)

- A.
7. Breathing hose - Connect to suit breathing connection and install safety clip.
 8. Amphenol plug - Connected and locked.
 9. Green apple cable - Position under right lap belt and secure with strap and snap. (Only on unmodified seat packs).
 10. Radio by pass cord - Under left lap belt.
 11. Harness - Connect shoulder harness to lap belt.
 12. F-1 release - Attach to lap belt and lock belt.
 13. Low altitude escape lanyard - Hooked to parachute "D" ring.
 14. Face heat - Attach emergency face heat cord to left side of faceplate; circuit breaker pulled.
 15. Face plate - Recheck locked and secure.
 16. Press-to-test - Check for oxygen leaks and for suit inflation in 7 seconds.
 17. Auxiliary power - Connected and On.
 18. Secondary oxygen valve - On.
 19. Primary oxygen valve - Off. Check that "PRIM OFF" oxygen warning light illuminated. Check that low pressure oxygen gage reads approximately 60 \pm 2 psi.
 20. Secondary oxygen valve - Turn Off momentarily and check that the "LOW PRESS" oxygen warning light is illuminated. Turn valve back On to restore oxygen flow to the pilot.
 21. Primary oxygen valve - On. With both valves On, check that both oxygen warning lights are out and that the low pressure oxygen gage reads 83 \pm 2 psi.
 22. Face heat - Check for face plate heat and advise pilot to check radio.
 23. Oxygen - Recheck aircraft and emergency supply.

TECHNICAL DATA CHANGETDC NO. FM-7 ~~REF~~ ~~SB~~ DOC Flight ManualPILOT EQUIPMENT CHECK (cont)

B. PILOT EQUIPMENT CHECK - LOW FLIGHT

1. Pilot enters cockpit.
2. Seat pack strap - Attach left seat pack strap to parachute and adjust.
3. Seat pack strap - Attach right seat pack strap to parachute and adjust.
4. Green apple cable - Position under right lap belt and secure with strap and snap. (Only on unmodified seat packs).
5. Radio by pass cord - Under left lap belt.
6. Harness - Connect shoulder harness to lap belt.
7. F-1 release - Attach to lap belt and lock belt.
8. Low altitude escape lanyard - Attach to parachute "D" ring.
9. Face heat - Stow the emergency face heat cord.
10. Pilot dons P-4B helmet.
11. Capstan hose - Capped off from seat pack.
12. Low altitude pressure reducer - Connect to the seat pack mask hose and install safety clip.
13. Oxygen mask hose - Connect to the low altitude pressure reducer.
14. Radio connector - Connect the amphenol plug to the seat pack amphenol plug and lock.
15. Helmet radio connector - Connect helmet male radio plug to the radio connector female plug.
16. Emergency oxygen bottle - Connect the parachute oxygen bottle to the bayonet connector on the helmet oxygen mask hose.
17. Auxiliary power - Connected and On.
18. Radio - Request pilot to check radio.
19. Oxygen - Request pilot to turn on primary oxygen system to check flow.
20. Oxygen pressure - Recheck aircraft, seat pack and parachute oxygen supply.

FLIGHT MANUAL TECHNICAL DATA CHANGE

TDC NO.

FM-8 MM-

AIRCRAFT DATA AFFECTED:

INSERT IN FRONT OF
AFFECTED MANUAL.

*Denotes pages changed,
added, or deleted by the
current change.

FLIGHT MANUAL		MAINT. MANUAL		DOC. NO.	REF: S.B./ NONE
SECTION	*PAGE	SECTION	*PAGE		
9	9-7				

NATURE OF CHANGE: REVISION OF ICING INFORMATION

(Delete) - Engine icing is not a problem in this aircraft.

(Add) - Engine icing can be experienced but apparently requires such precise conditions that it is quite uncommon. If fog is present or the dew-point is within 4°C of the ambient temperature, conditions exist under which jet engine icing can occur without wing icing. Ice can build up on the inlet guide vanes of the engine when the airplane is flown through areas where icing conditions prevail. Icing of the guide vanes effects the flow of air, causing loss of thrust and roughness. Extreme conditions could cause a flameout. Ice on the fuel control sense probe can cause erratic power control. If after flying thru engine icing conditions, engine operation indicates ice has been picked up, appropriate action must be taken.

1. Engine roughness - Find best power setting and land as soon as practicable.
2. Engine roughness and erratic power control - Reduce power and switch to emergency fuel control. Land as soon as practicable.

NOTE: The technical data information furnished herein is intended to be used as INTERIM data only. It will be replaced and superseded at the time of issue of the first change to the affected manual(s)

APPROVED: *L. J. Johnson* 25 SEP 59 9-24-59

TECHNICAL DATA CHANGE

TDC NO.

FM-6 MM-

AIRCRAFT DATA AFFECTED:

INSERT IN FRONT OF
AFFECTED MANUAL.

*Denotes pages changed,
added, or deleted by the
current change.

FLIGHT MANUAL		MAINT. MANUAL		DOC. NO.	REF: S.B./ None
SECTION	*PAGE	SECTION	*PAGE		
3	3-25				
5	5-2 5-3 5-4				

NATURE OF CHANGE: ENGINE OIL PRESSURE LIMIT.

Engine oil pressure normal range upper limit being
increased from 50 psi to 55 psi.

Sect. 3
Page 3-25 ENGINE OIL SYSTEM MALFUNCTION

Revise first sentence to read 40 to 55 psi.

Sect. 5
Page 5-2 OIL PRESSURE

Revise first sentence to read 40 to 55 psi.

Sect. 5
Page 5-3 Revise wording under Oil Pressure Indicator to read 40 - 55 psi normal. Relocate red line to 55 psi mark and extend green arc to 55 psi.

Sect. 5
Page 5-4 OIL PRESSURE

Revise Normal to read 40-55 psi.

NOTE: The technical data information furnished herein is intended to be used as INTERIM data only. It will be replaced and superseded at the time of issue of the first change to the affected manual(s)

APPROVED: *L. J. Johnson* 25 SEP 59 9-24-59

TECHNICAL DATA CHANGE

TDC NO.

FM-1 > MM-

AIRCRAFT DATA AFFECTED:

INSERT IN FRONT OF AFFECTED MANUAL.
*Denotes pages changed, added, or deleted by the current change.

FLIGHT MANUAL		MAINT. MANUAL		DOC. NO.
SECTION	*PAGE	SECTION	*PAGE	
1V	4-11			REF: S.B./399

NATURE OF CHANGE: USE OF A-13A MASK ADAPTER IN O₂ SYSTEM

Delete all text under "EQUIPMENT SELECTION" and substitute the following:

On all flights above 45,000 feet the pressure suit is mandatory.

An adapter to permit the use of an A-13A oxygen mask in lieu of the MA-2 helmet may be used for low altitude flight up to 45,000 feet, when use of the MA-2 helmet and the partial pressure suit is not desired.

WARNING

The MA-2 pressure helmet should not be worn without the suit as it requires tiedown provisions. Loss of cabin pressure can cause the helmet to rise dangerously high or it could be torn off during bailout causing loss of oxygen facilities.

Under normal operating conditions the output safety pressure from the seat pack is too great for use of an A-13A mask. Its use under such conditions is unsatisfactory resulting in garbled radio transmissions and breathing discomfort. Therefore, a reduction in outlet pressure from the seat pack to mask is required. This is accomplished by inserting a pressure reducer (mask-adapter) in the outlet-end of the seat pack hose to reduce the outlet pressure by a ratio of approximately 2.8 to 1.

NOTE

A Lombard or P4 helmet should be used with the A-13A oxygen mask.

NOTE: The technical data information furnished herein is intended to be used as INTERIM data only. It will be replaced and superseded at the time of issue of the first change to the affected manual(s)

TECHNICAL DATA CHANGE

TDC NO.

FM-2 > MM-

AIRCRAFT DATA AFFECTED:

INSERT IN FRONT OF AFFECTED MANUAL.
*Denotes pages changed, added, or deleted by the current change.

FLIGHT MANUAL		MAINT. MANUAL		DOC. NO.
SECTION	*PAGE	SECTION	*PAGE	
5	5-5			REF: S.B./407

NATURE OF CHANGE: WING FLAP EXTENTION AIRSPEED LIMITATIONS

Under the heading:

CONFIGURATION

MAX. ALLOWABLE AIRSPEED

GENERAL

DELETE the second sentence in its entirety.

SUBSTITUTE	Wing Flaps Extended up to 25°	130 Knots
	Wing Flaps Extended over 25°	100 Knots

APPROVED: [Signature]

NOTE: The technical data information furnished herein is intended to be used as INTERIM data only. It will be replaced and superseded at the time of issue of the first change to the affected manual(s)

TECHNICAL DATA CHANGE

TDC NO.

FM- 3 > MM-

AIRCRAFT DATA
AFFECTED:

INSERT IN FRONT OF
AFFECTED MANUAL.
*Denotes pages changed,
added, or deleted by the
current change.

FLIGHT MANUAL		MAINT. MANUAL		DOC. NO.	REF: S.B./
SECTION	*PAGE	SECTION	*PAGE		
4	4-8				
	4-9				
	4-11				

NATURE OF CHANGE: REVISE "OXYGEN SYSTEM", AS NOTED.

Page 4-8 GENERAL:

Primary Reducer 83 ± 2 psi (was 82)
Secondary Reducer 60 ± 2 psi (was 68)
Lo-Press Lite (Red) 50 ± 3 psi (was 60 ± 2)

Delete Note on "Single Supply Oxygen System"

PRE-FLIGHT CHECK:

Para. 4 - 60 psi. (was 68)

Page 4-9 NORMAL OPERATION

Para. 4 - 50 psi (was 60)

EMERG. OPERATION:

50 psi (was 60) - 3 places.

Page 4-11 EQUIPMENT SELECTION:

4th Paragraph - Delete last sentence and a, b & c.

Add - This may be remedied by use of 258-01 reducing
valve and A2 259 adapter, between the seat pack
and the oxygen mask.

TECHNICAL DATA CHANGE

TDC NO.

FM- 4 > MM-

AIRCRAFT DATA
AFFECTED:

INSERT IN FRONT OF
AFFECTED MANUAL.
*Denotes pages changed,
added, or deleted by the
current change.

FLIGHT MANUAL		MAINT. MANUAL		DOC. NO.	REF: S.B./
SECTION	*PAGE	SECTION	*PAGE		
2	2-27				

NATURE OF CHANGE: AIRCRAFT CONTROL

Add following paragraph after altitude-airspeed tabulation
under "AIRCRAFT CONTROL".

The best cruise performance is obtained by flying the speed schedule as precisely as possible. If the speed is too fast the airplane will not climb at the proper rate. This can increase fuel consumption and decrease range. The optimum procedure is to establish the airspeed for the next highest altitude and allow the airplane to climb. When this altitude is reached, the speed should again be reduced to the value required for the next highest altitude. This can be accomplished by interpolating the speed schedule for altitude increments of 500 or 1000 feet. If the autopilot Mach sensor does not control the airspeed with reasonable accuracy the expected performance will not be realized. This should be reported for corrective action.

NOTE: The technical data information furnished herein is intended to be used as INTERIM data only. It will be replaced and superseded at the time of issue of the first change to the affected manual(s)

NOTE: The technical data information furnished herein is intended to be used as INTERIM data only. It will be replaced and superseded at the time of issue of the first change to the affected manual(s)

R. G. Ublech

TECHNICAL DATA CHANGE

TDC NO.

FM- 6 > MM-

TECHNICAL DATA CHANGE

TDC NO.

COPY NO. **7**

FM- 7 > MM-

AIRCRAFT DATA AFFECTED:

INSERT IN FRONT OF AFFECTED MANUAL.
*Denotes pages changed, added, or deleted by the current change.

FLIGHT MANUAL		MAINT. MANUAL		DOC. NO.	None
SECTION	*PAGE	SECTION	*PAGE		
3	3-25				REF: S.B.
5	5-2				
	5-3				
	5-4				

NATURE OF CHANGE: **ENGINE OIL PRESSURE LIMIT.**

Engine oil pressure normal range upper limit being increased from 50 psi to 55 psi.

Sect. 3
Page 3-25

ENGINE OIL SYSTEM MALFUNCTION

Revise first sentence to read 40 to 55 psi.

Sect. 5
Page 5-2

OIL PRESSURE

Revise first sentence to read 40 to 55 psi.

Sect. 5
Page 5-3

Revise wording under Oil Pressure Indicator to read 40 - 55 psi normal. Relocate red line to 55 psi mark and extend green arc to 55 psi.

Sect. 5
Page 5-4

OIL PRESSURE

Revise Normal to read 40-55 psi.

APPROVED: *L. J. Sullivan* 25 SEP 59 9-24-59

AIRCRAFT DATA AFFECTED:

INSERT IN FRONT OF AFFECTED MANUAL.
*Denotes pages changed, added, or deleted by the current change.

FLIGHT MANUAL		MAINT. MANUAL		DOC. NO.	None
SECTION	*PAGE	SECTION	*PAGE		
II	2-8				REF: S.B.
	2-9				
	2-10				
	2-11				

NATURE OF CHANGE: Revision of Pilot Check Lists

Delete the sections "PRIOR TO BOARDING AIRCRAFT" and "PILOT EQUIPMENT CHECK" and substitute the following:

PRIOR TO BOARDING AIRCRAFT

When the pilot arrives at the aircraft, qualified personnel will be available to assist him in performing check lists up to engine start.

NOTE

In hot or extremely cold weather, every effort should be made to keep the pilot at a comfortably cool temperature prior to starting engines. If the pilot becomes too warm, he will perspire excessively; too cold a temperature results in pilot discomfort plus excessive face plate fogging.

1. Form 781 - Checked by pilot and Part 2 signed.
2. Shoulder straps and safety belt - Fully extended to facilitate pilot hook-up.
3. Relief bottle - Installed.
4. Seat blocks and back cushion - Installed as required.
5. Seat pack - Installed.

APPROVED: *R. G. Ublech* 11-10-59

NOTE: The technical data information furnished herein is intended to be used as INTERIM data only. It will be replaced and superseded at the time of issue of the first change to the affected manual(s)

NOTE: The technical data information furnished herein is intended to be used as INTERIM data only. It will be replaced and superseded at the time of issue of the first change to the affected manual(s)

TECHNICAL DATA CHANGETDC NO. FM-7 ~~REF~~ ~~SB~~ DOC Flight ManualPRIOR TO BOARDING AIRCRAFT (cont)

6. Seat pack quick disconnect and connections - Recheck properly connected to aircraft systems and safety clips attached.
7. Quick disconnect - Check for safety pin installed. Advise crew chief if pin missing.
8. Check aircraft oxygen supply - 1700 to 1850 psi.
9. Check oxygen supply in seat pack - 1800 psi.
10. Parachute - Fitted to pilot.
11. Underarm preserver - Flotation kits pulled through parachute sling assembly and positioned outside the parachute harness. (Applicable to over water flight only).
12. Partial pressure suit capstan and breathing bladder hoses - Extended and free of parachute harness. (Applicable for high flight only).

PILOT EQUIPMENT CHECK

A qualified personal equipment technician should be available to assist in the hookup and checking of these items. This method will substantially reduce pilot fatigue and irritation in this period prior to start of the flight.

A. PILOT EQUIPMENT CHECK - HIGH FLIGHT

1. Pilot enters aircraft.
2. Seat pack strap - Attach left seat pack strap to parachute and adjust.
3. Seat pack strap - Attach right seat pack strap to parachute and adjust.
4. Capstan hose - Connect to seat pack suit hose and install safety clip.
5. Bladder hose - Connect to seat pack mask hose and install safety clip.
6. Primary aircraft oxygen system only - On.

TECHNICAL DATA CHANGETDC NO. FM-7 ~~REF~~ ~~SB~~ DOC Flight ManualPILOT EQUIPMENT CHECK (cont)

- A. 7. Breathing hose - Connect to suit breathing connection and install safety clip.
8. Amphenol plug - Connected and locked.
9. Green apple cable - Position under right lap belt and secure with strap and snap. (Only on unmodified seat packs).
10. Radio by pass cord - Under left lap belt.
11. Harness - Connect shoulder harness to lap belt.
12. F-1 release - Attach to lap belt and lock belt.
13. Low altitude escape lanyard - Hooked to parachute "D" ring.
14. Face heat - Attach emergency face heat cord to left side of faceplate; circuit breaker pulled.
15. Face plate - Recheck locked and secure.
16. Press-to-test - Check for oxygen leaks and for suit inflation in 7 seconds.
17. Auxiliary power - Connected and On.
18. Secondary oxygen valve - On.
19. Primary oxygen valve - Off. Check that "PRIM OFF" oxygen warning light illuminated. Check that low pressure oxygen gage reads approximately 60 / 2 psi.
20. Secondary oxygen valve - Turn Off momentarily and check that the "LOW PRESS" oxygen warning light is illuminated. Turn valve back On to restore oxygen flow to the pilot.
21. Primary oxygen valve - On. With both valves On, check that both oxygen warning lights are out and that the low pressure oxygen gage reads 83 / 2 psi.
22. Face heat - Check for face plate heat and advise pilot to check radio.
23. Oxygen - Recheck aircraft and emergency supply.

TECHNICAL DATA CHANGE

TDC NO. FM-7 REF SB DOC Flight Manual

PILOT EQUIPMENT CHECK (cont)

B. PILOT EQUIPMENT CHECK - LOW FLIGHT

1. Pilot enters cockpit.
2. Seat pack strap - Attach left seat pack strap to parachute and adjust.
3. Seat pack strap - Attach right seat pack strap to parachute and adjust.
4. Green apple cable - Position under right lap belt and secure with strap and snap. (Only on unmodified seat packs).
5. Radio by pass cord - Under left lap belt.
6. Harness - Connect shoulder harness to lap belt.
7. F-1 release - Attach to lap belt and lock belt.
8. Low altitude escape lanyard - Attach to parachute "D" ring.
9. Face heat - Stow the emergency face heat cord.
10. Pilot dons P-4B helmet.
11. Capstan hose - Capped off from seat pack.
12. Low altitude pressure reducer - Connect to the seat pack mask hose and install safety clip.
13. Oxygen mask hose - Connect to the low altitude pressure reducer.
14. Radio connector - Connect the amphenol plug to the seat pack amphenol plug and lock.
15. Helmet radio connector - Connect helmet male radio plug to the radio connector female plug.
16. Emergency oxygen bottle - Connect the parachute oxygen bottle to the bayonet connector on the helmet oxygen mask hose.
17. Auxiliary power - Connected and On.
18. Radio - Request pilot to check radio.
19. Oxygen - Request pilot to turn on primary oxygen system to check flow.
20. Oxygen pressure - Recheck aircraft, seat pack and parachute oxygen supply.

TECHNICAL DATA CHANGE

TDC NO. FM-8 MM-

AIRCRAFT DATA AFFECTED:

INSERT IN FRONT OF AFFECTED MANUAL.
*Denotes pages changed, added, or deleted by the current change.

FLIGHT MANUAL		MAINT. MANUAL		DOC. NO.	REF: S.B./NONE
SECTION	*PAGE	SECTION	*PAGE		
9	9-7				

APPROVED: *P. L. Sullivan* 1-11-60

NATURE OF CHANGE: REVISION OF ICING INFORMATION

- (Delete) - Engine icing is not a problem in this aircraft.
- (Add) - Engine icing can be experienced but apparently requires such precise conditions that it is quite uncommon. If fog is present or the dew-point is within 4°C of the ambient temperature, conditions exist under which jet engine icing can occur without wing icing. Ice can build up on the inlet guide vanes of the engine when the airplane is flown through areas where icing conditions prevail. Icing of the guide vanes effects the flow of air, causing loss of thrust and roughness. Extreme conditions could cause a flameout. Ice on the fuel control sense probe can cause erratic power control. If after flying thru engine icing conditions, engine operation indicates ice has been picked up, appropriate action must be taken.
1. Engine roughness - Find best power setting and land as soon as practicable.
 2. Engine roughness and erratic power control - Reduce power and switch to emergency fuel control. Land as soon as practicable.

NOTE: The technical data information furnished herein is intended to be used as INTERIM data only. It will be replaced and superseded at the time of issue of the first change to the affected manual(s)

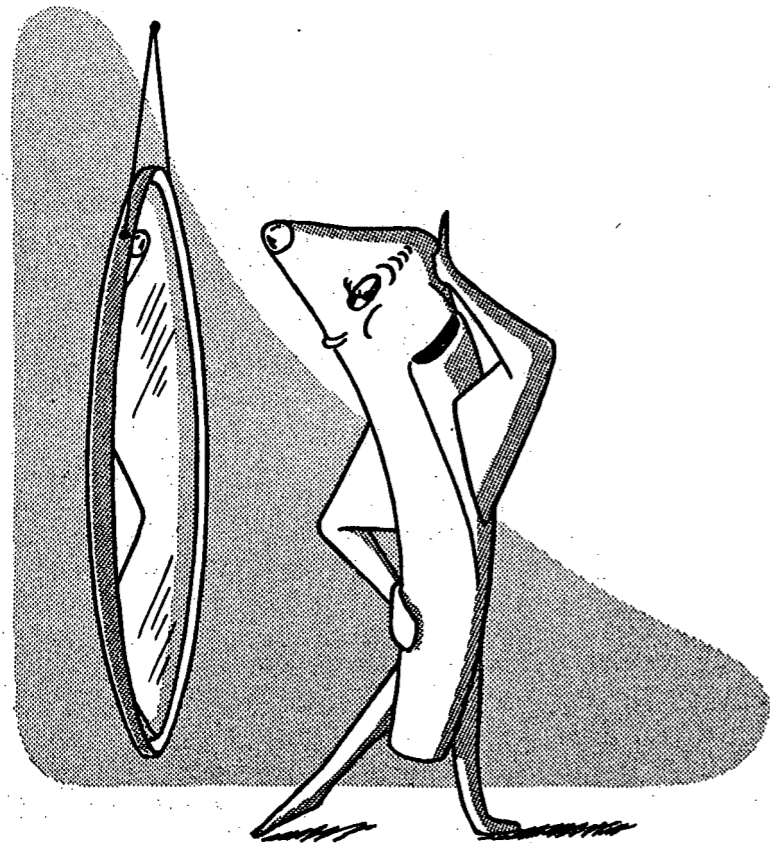

SECURITY INFORMATION

SPECIFIC INSTRUCTIONS FOR SAFEGUARDING THIS MILITARY INFORMATION

1. This document is classified as SECRET in accordance with AFR 205-1 and contains information affecting the national defense of the United States within the meaning of the Espionage Laws Title 18, USC Section 793 and 794. The transmission or the revelation of its contents in any manner to unauthorized persons is prohibited by law.

By direction of the Chief of Staff, United States Air Force, the nature of this document is such that dissemination and handling will be carried out with strict adherence to the following policies:

- a. This document may not be transmitted through mail channels.
 - b. Distribution will be controlled on a strict, officially established "need-to-know" basis.
 - c. Strict accountability of each document will be maintained.
 - d. Dissemination and handling will be carried out by direct contact only, as is the case with TOP SECRET material.
2. In the event this document becomes lost or is subject to unauthorized disclosure or other possible subjection to compromise of classified information, such fact will be promptly reported to the Commander for the custody of the material, for action in accordance with AFR 205-1.

TABLE OF CONTENTS

	PAGE
THE AIRCRAFT	1-3
ENGINE	1-3
ENGINE FUEL SYSTEM	1-3
ENGINE OIL SYSTEM	1-7
IGNITION SYSTEM	1-7
STARTER SYSTEM	1-7
COMPRESSOR BLEED VALVE	1-13
ENGINE INSTRUMENTS	1-13
AIRPLANE FUEL SYSTEM	1-15
ELECTRICAL SYSTEM	1-19
HYDRAULIC SYSTEM	1-21
FLIGHT CONTROL SYSTEM	1-21
WING FLAPS	1-23
SPEED BRAKES	1-24
LANDING GEAR	1-24
STEERING SYSTEM	1-25
WHEEL BRAKES	1-25
DRAG CHUTE	1-27
INSTRUMENTS	1-27
FIRE WARNING SYSTEM	1-30
SPEED WARNING SYSTEM	1-30
CANOPY	1-30
PILOT'S SEAT	1-31
AUXILIARY EQUIPMENT	1-31

SECTION 1

WARNINGS, CAUTIONS, AND NOTES

For your information, the following definitions apply to the "Warning", "Cautions", and "Notes" found throughout the handbook.

WARNING

Operating procedures, practices, etc, which will result in personal injury or loss of life if not carefully followed.

CAUTION

Operating procedures, practices, etc., which if not strictly observed will result in damage to equipment.

NOTE

An operating procedure, condition, etc., which it is essential to emphasize.

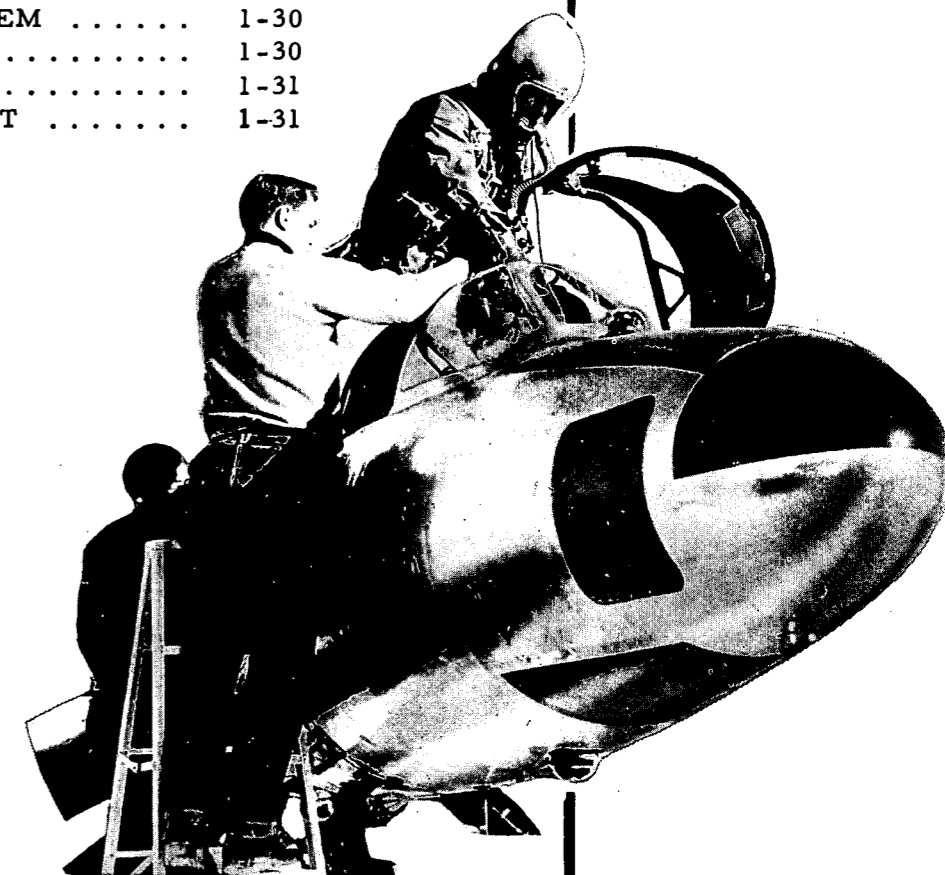

DESCRIPTION

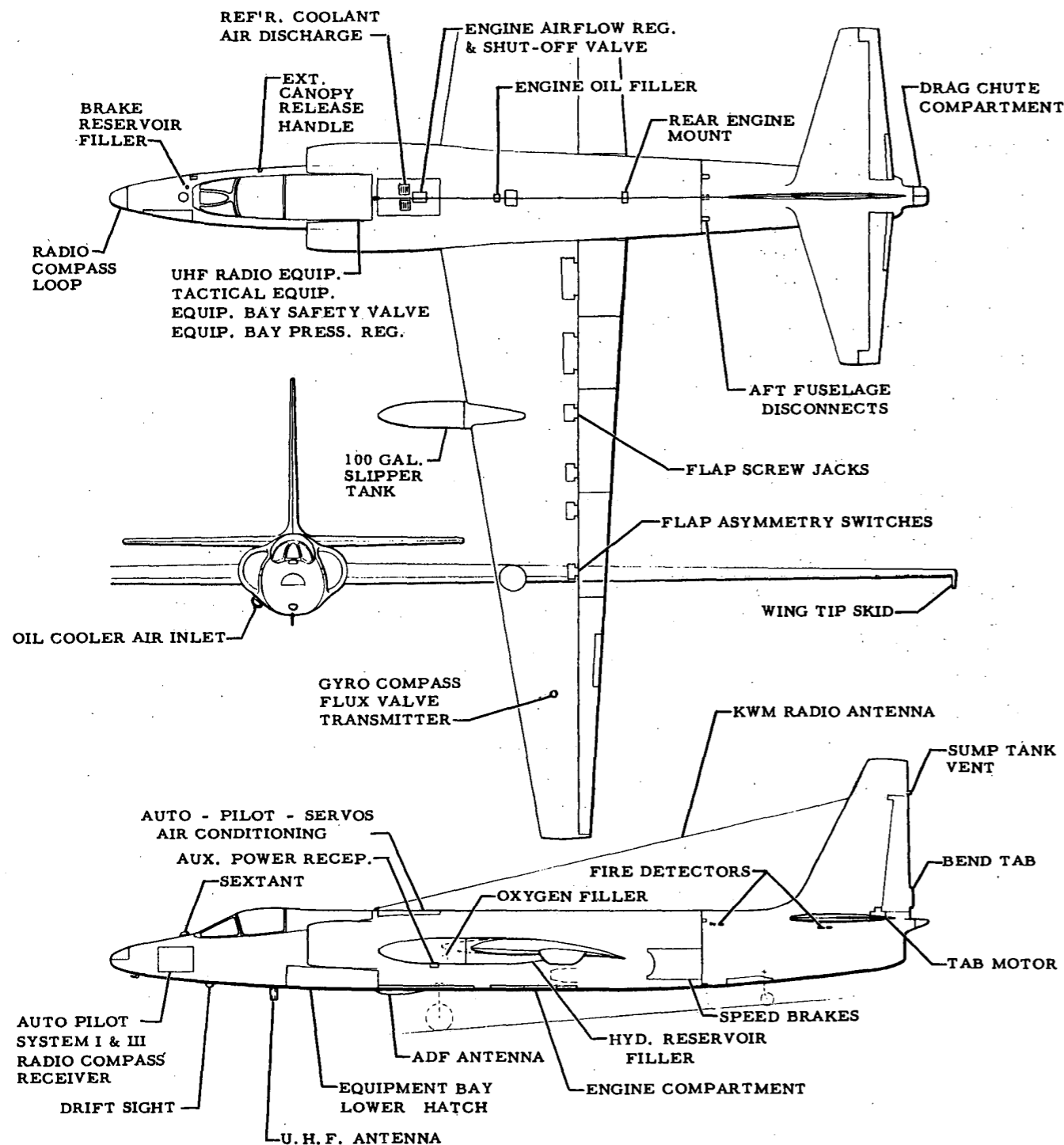

GENERAL CONFIGURATION
FIG. 1-1

THE AIRCRAFT

GENERAL

The U-2 is a single place, jet propelled aircraft designed for very high altitude, long range operation. The basic configuration is fitted for photo reconnaissance. Various other equipment can also be installed for special purposes. Refer to Figure 1-1 for general configuration information.

BASIC DIMENSIONS

Wing Area	600 sq. ft.
Wing Span	80 ft.
Aspect Ratio	10.67
Wing Average Thickness	7.8%
Fuselage Length	49.7 ft.

GROSS WEIGHTS

Condition	Gross Weight With J57-P-31A Engine
Full main and empty aux. tanks (1035 gal.)	18,125 lbs.
Full main and full aux. tanks (1335 gal.)	20,100 lbs.
Full main, aux. and slipper tanks (1535 gal.)	21,545 lbs.
Design Landing Weight (46 gal.)	11,620 lbs.
Nominal Landing Weight (550 gal.)	15,000 lbs.

Notes:

1. The above data are computed for an average equipment bay load. Also, substitution of the J57-P-37 engine and added oil will result in a weight increase of approximately 473 lbs.

2. See Section VII for a discussion of design and nominal landing weights.

ENGINE

GENERAL

The aircraft is powered by a single J57 type non-afterburning engine (Figure 1-2) which employs an axial flow, twin spool compressor, and a split three-stage turbine. The front compressor is a nine stage low pressure unit which is connected by a through shaft to the second and third stage turbine wheels. The seven stage aft, or high pressure, compressor is mechanically independent of the front compressor and is connected by a hollow shaft to the first stage turbine wheel. This arrangement permits the low pressure rotor to turn at its best speed and allows higher compression ratios.

Two models of the J-57 engine may be installed interchangeably in the U-2 aircraft; the J57-P-37 and the J57-P-31A.

J57-P-37 ENGINE

This model is utilized primarily for training. It is rated at 10,500 pounds static thrust.

J57-P-31A ENGINE

This is a later engine which was designed especially for high altitude operation. A number of significant changes were made in the P-31 engine to provide more thrust at high altitude, improved fuel consumption and wider operating margins.

The P-31 is 415 pounds lighter than the P-37, and also requires 60 pounds less oil. The airplane weight is correspondingly affected.

The sea level static thrust rating is 11,200 pounds.

ENGINE FUEL SYSTEM

GENERAL

The J57 engine fuel system consists of the

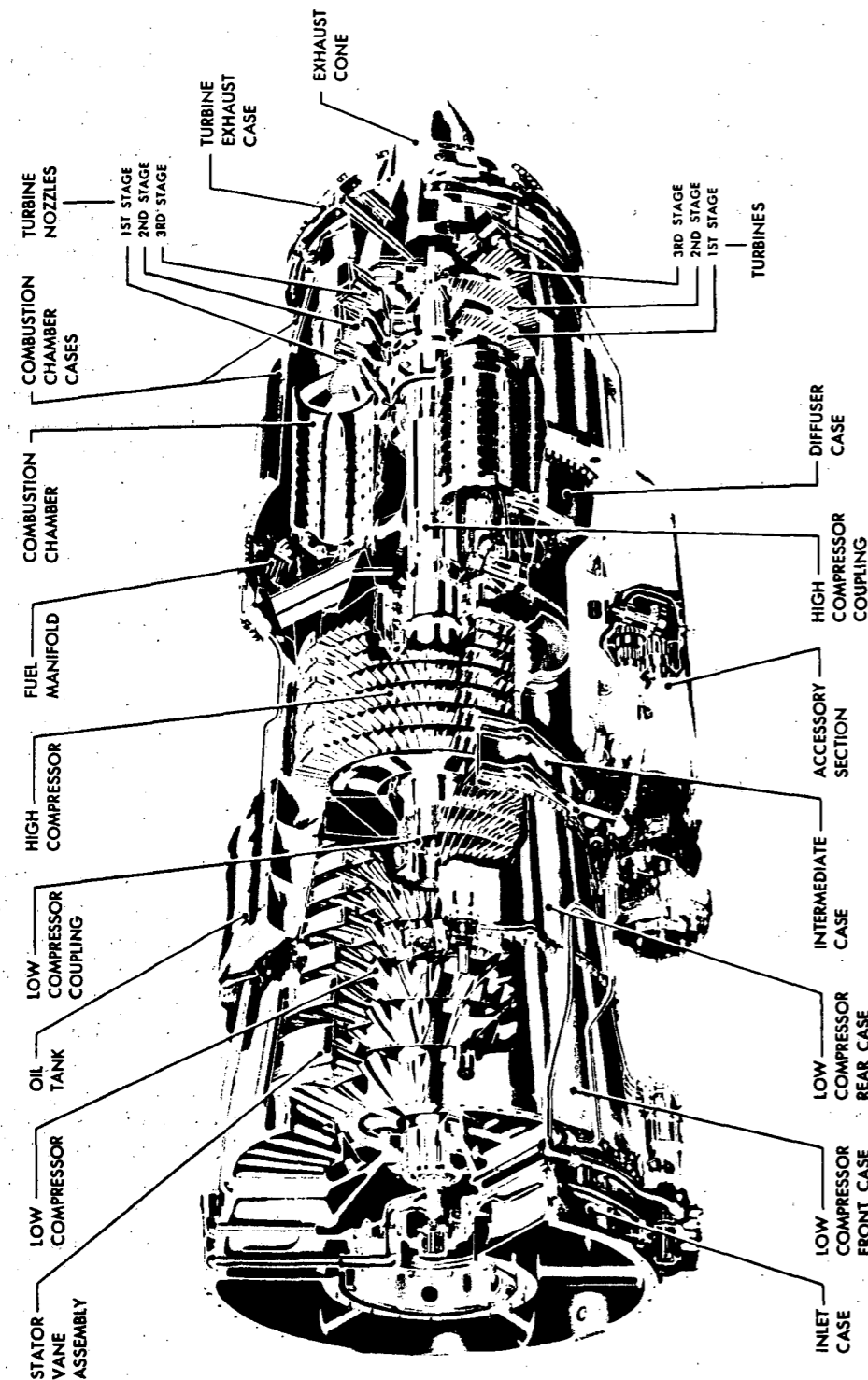

J-57 ENGINE CUTAWAY
FIG. 1-2

following major engine mounted components, a schematic diagram of which is shown in Figure 1-3:

1. Two stage gear type pump.
2. Hamilton Standard hydromechanical fuel control.
3. Fuel manifold pressurizing valve and automatic fuel manifold drain valve.
4. Forty eight dual-orifice fuel nozzles.

ENGINE FUEL PUMP

The engine driven fuel pump has a low pressure stage and a high pressure stage and supplies pressure for both the normal and the emergency fuel systems. During operation the low pressure stage acts as an engine driven boost pump and increases fuel pressure to the inlet of the high pressure stage. Should the airplane boost pump fail, the engine pump will supply sufficient fuel flow to maintain flight up to approximately 55,000 feet. In the event of a failure of the low pressure stage, adequate fuel pressure at the inlet to the high pressure (main) stage of the engine fuel pump can be maintained by the airplane boost pump through a bypass valve. If the high pressure stage of the engine pump fails, flame out will result and a restart cannot be made. However, no difficulty has been experienced with either stage of the engine fuel pump.

MAIL FUEL CONTROL

The fuel control regulates engine speed by means of a fly-ball governor for all operating conditions, including starting, acceleration and deceleration. During starting and acceleration the control limits fuel flow to prevent compressor surge and over-temperature. During deceleration, the control schedules a minimum fuel flow to prevent flame out. This minimum flow schedule also determines the idle RPM at altitude. In addition, the control incorporates a maximum burner pressure limiter which limits the maximum output of the engine to a safe

level so as to prevent damage to the combustion chamber case due to over-pressure.

During climb at a fixed throttle setting, the fuel control in general will reduce engine speed. However, exhaust gas temperature (EGT) will increase during a fixed throttle climb. Maximum power climbs can generally be made to about 50,000 feet without any throttle movement. Some engines will require throttling below 10,000 feet. On most engines it is necessary to slightly throttle back above 50,000 feet to avoid exceeding limit EGT, engine speed or pressure ratio.

The fuel control installed on the P-37 type engine senses compressor inlet temperature and is scheduled to decrease engine speed as the temperature decreases. The control on the P-31 engine is the pressure bias type which senses engine air inlet total pressure rather than temperature. Also, some P-31 fuel controls have dual minimum flow settings. The higher setting is used for air starts; the lower setting for minimum engine power. In other respects the P-31 and P-37 fuel controls are similar.

THROTTLE

Engine power is controlled by a single lever in the cockpit. The throttle position establishes a power condition for which the fuel control meters fuel to the engine with automatic compensation for RPM, compressor inlet temperature or pressure and burner pressure. At a given throttle position the engine will deliver a constant percentage of the maximum thrust available at a given flight altitude. The throttle has an "OFF" position, an "IDLE" position and a power selection range from "IDLE" to "MILITARY". In the "OFF" position all fuel to the burners is cut off.

Throttle friction may be regulated by a knob located on the inboard side of the console below the throttle. In order to provide for very small movements of the throttle at high altitude, a vernier wheel is installed just inboard of the lever. The microphone switch and speed brake control are also located on

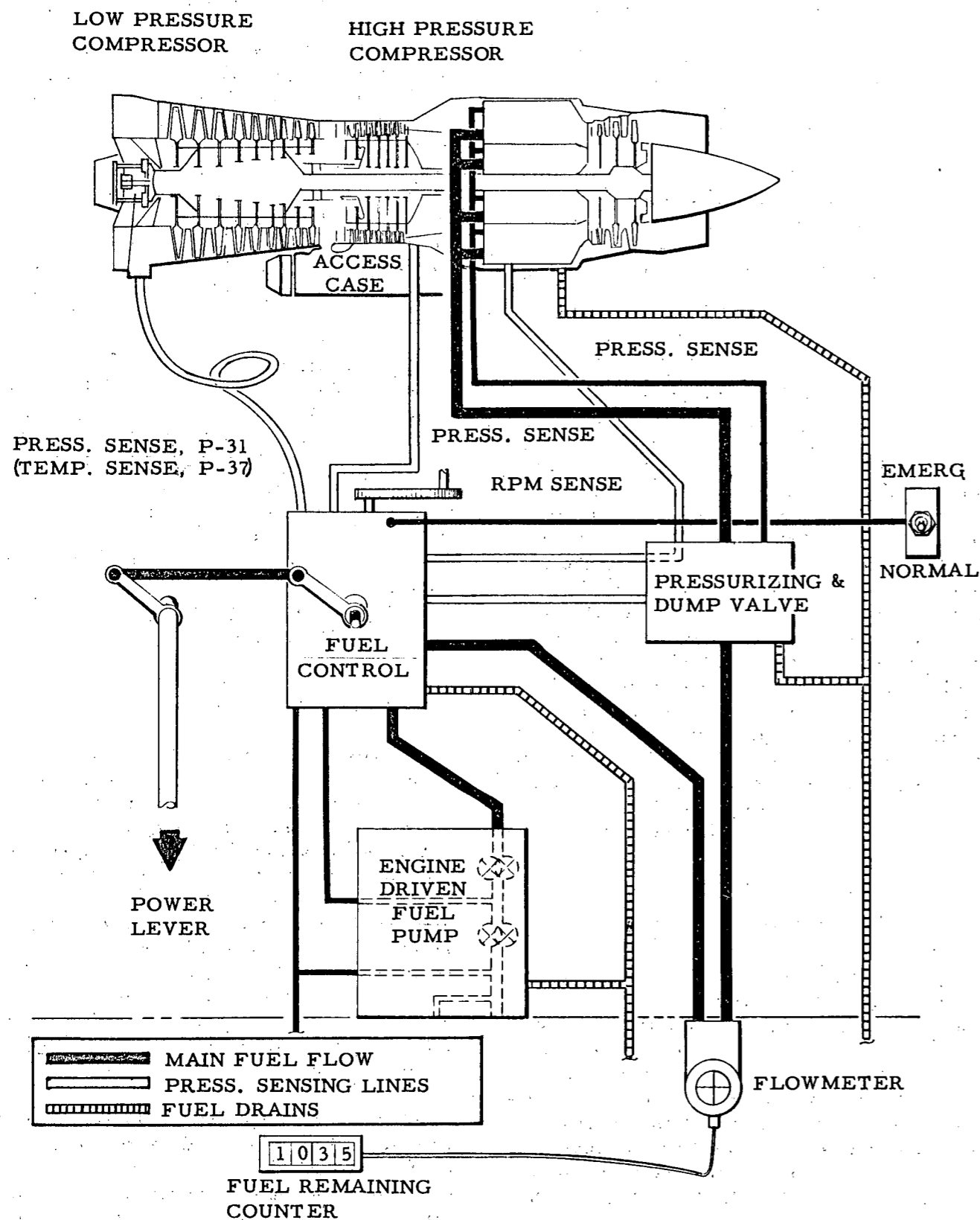

ENGINE FUEL SYSTEM

FIG. 1-3

SECRET

the handle of the throttle.

EMERGENCY FUEL SYSTEM

The emergency fuel system by-passes the compensating sections of the main fuel control so that fuel flow is manually selected and controlled. There is altitude compensation to only 30,000 feet; therefore, it is necessary to make extremely careful throttle movements during emergency operation in order to avoid overspeeding and over-temperature.

A fuel system selector switch is provided on the right hand side of the instrument panel below the pressure ratio indicator. This is a three position switch and is normally "UP" for main fuel system operation. The switch is momentarily held down for switching to the emergency fuel system, AND WHEN RELEASED WILL RETURN TO THE NEUTRAL OR STRAIGHT OUT POSITION. An emergency fuel system light is located to the left of the switch. This is an amber light which is "ON" when operating on the emergency fuel system. The light also glows during the initial portion of a normal engine start.

NOTE

The main fuel system will operate with the switch in the center position unless the switch is momentarily held down. The emergency fuel system is not automatic and must be manually selected when desired.

ENGINE OIL SYSTEM

The engine oil system is automatic and requires no controls. The system is comprised of a pressure oil system, scavenge oil system, breather pressurizing system and oil cooling system as shown in Figure 1-4.

The pressure system is supplied with oil from a tank mounted on top of the engine

compressor section. This tank contains 16 gallons on the P-37 engine and 8 gallons on the P-31 engine. Bearing lubrication is provided by an engine driven gear type pump whose discharge pressure is regulated by a pressure relief valve. Five engine driven pumps withdraw the scavenge oil from the bearing compartments and accessories and force it out through the oil cooler mounted in the airplane fuselage, then through a fuel-oil heat exchanger and back to the tank. The breather pressurizing system is provided to improve oil pump performance at altitude. The pressure is automatically controlled by an aneroid operated valve.

Oil temperature is not monitored in the cockpit since this was found to be unnecessary.

IGNITION SYSTEM

This is a high energy, capacitor type ignition system. Two separate exciter units are provided which feed the high energy spark to two separate spark igniters in the combustion chamber. The ignition is controlled by a single spring loaded switch located on the lower left of the instrument panel. The two exciter units are powered from separate electrical circuit breakers so that failure of one exciter will not cause complete system failure. A single exciter is sufficient for making an air or ground start.

The P-31 engine is equipped with a 20 joule ignition system, which is a substantial increase in energy over that provided on the P-37.

STARTER SYSTEM

An orthodox air turbine starter is provided for ground starts. An external air supply furnishes the necessary power. There are no airplane controls for this system. It is turned on and off by the ground crew according to signals given by the pilot. Air starts do not require a starter and are made by windmilling the engine.

SECRET

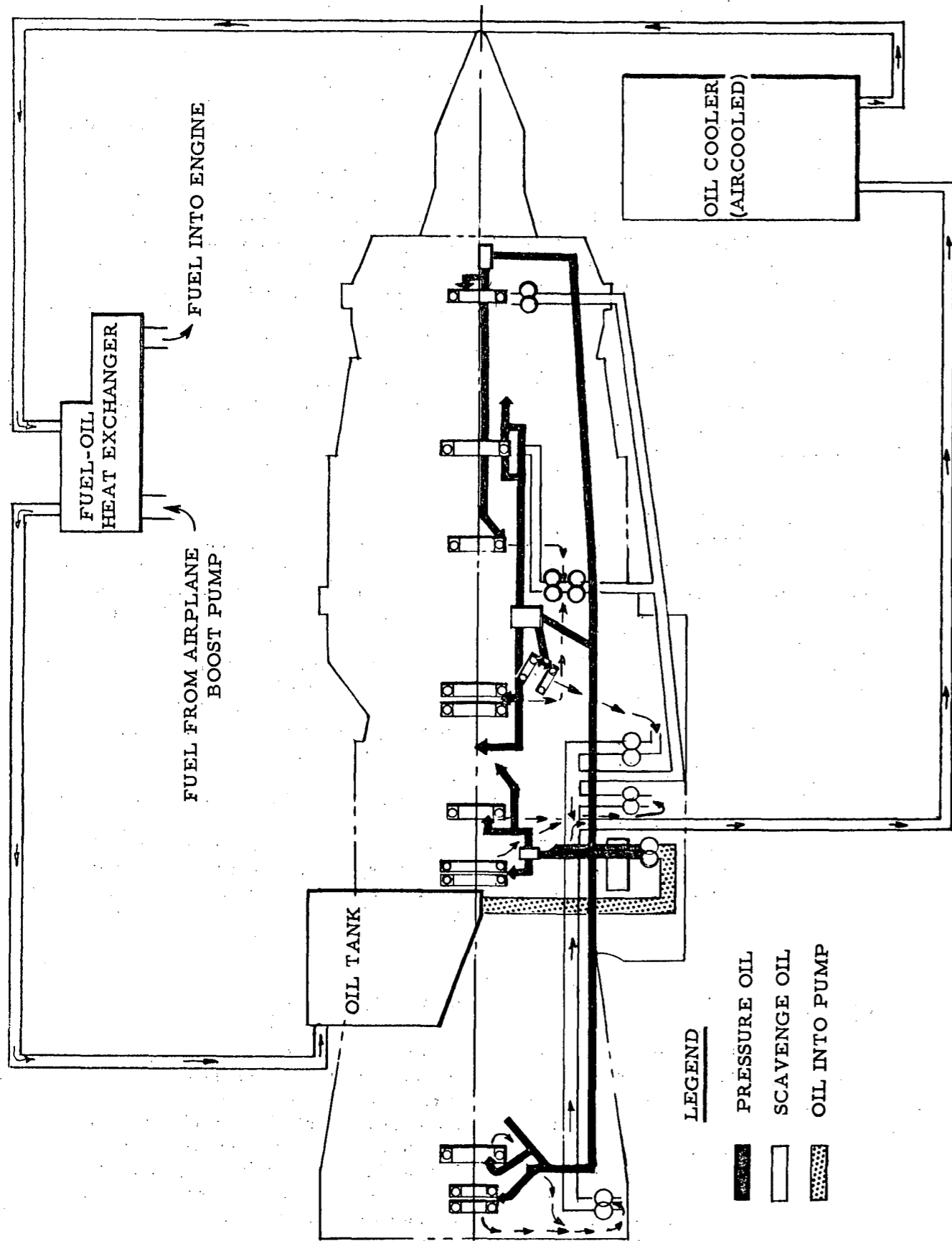

ENGINE OIL SYSTEM
FIG. 1-4

~~SECRET~~

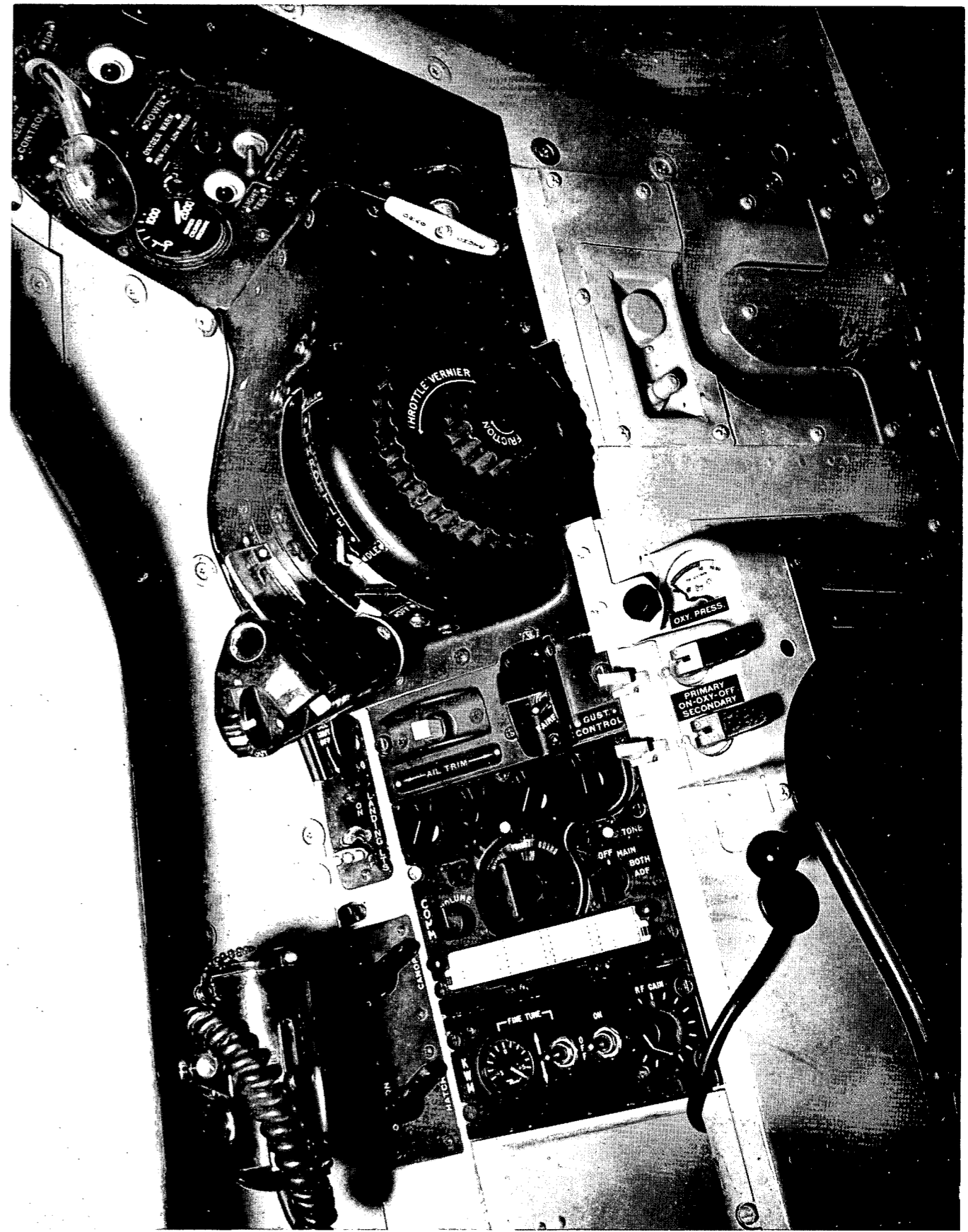
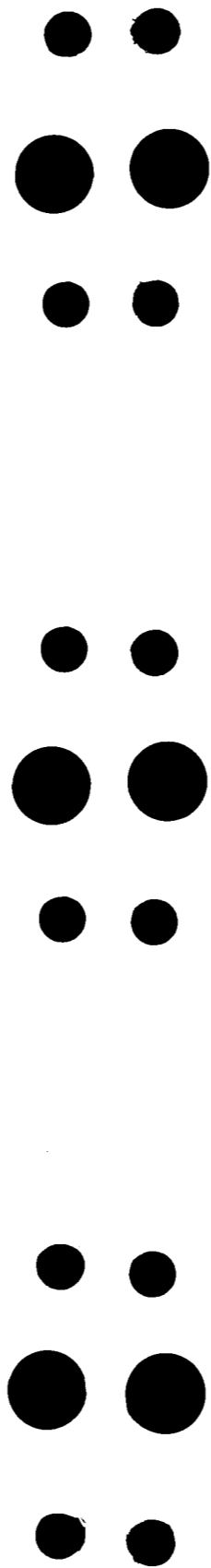

LEFT SIDE CONSOLE
FIG. 1-5

~~SECRET~~

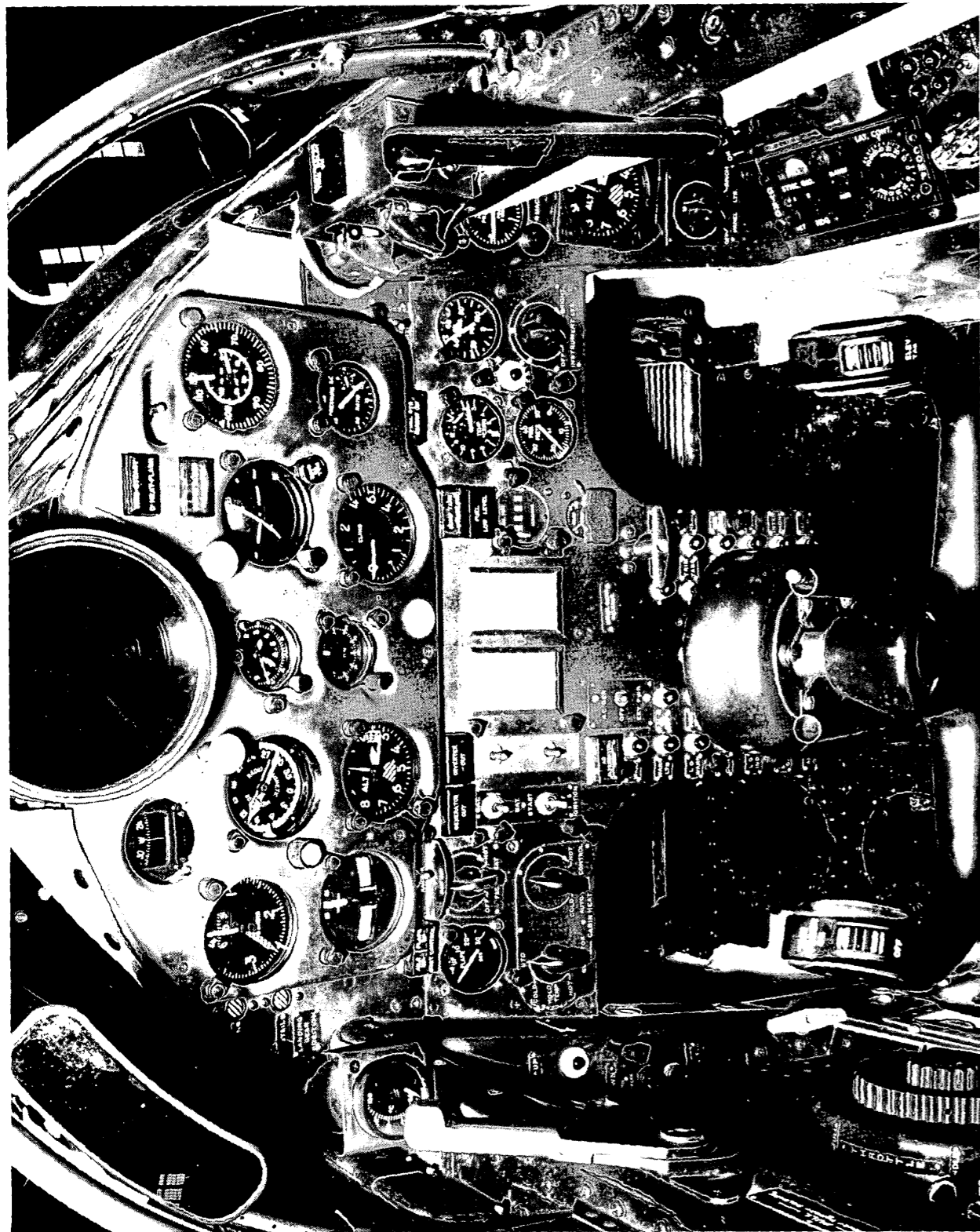

COCKPIT INSTRUMENT PANEL
FIG. 1-6

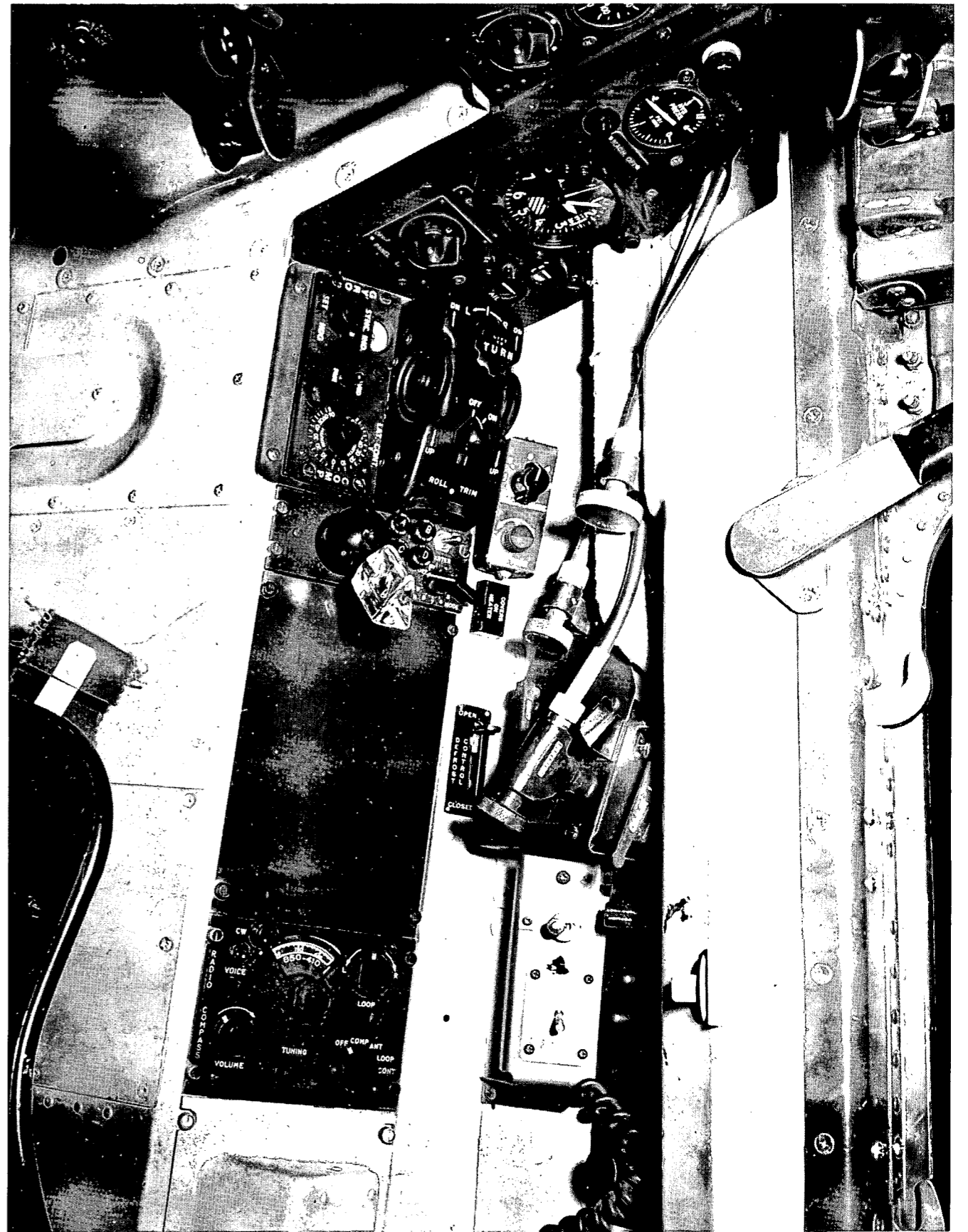
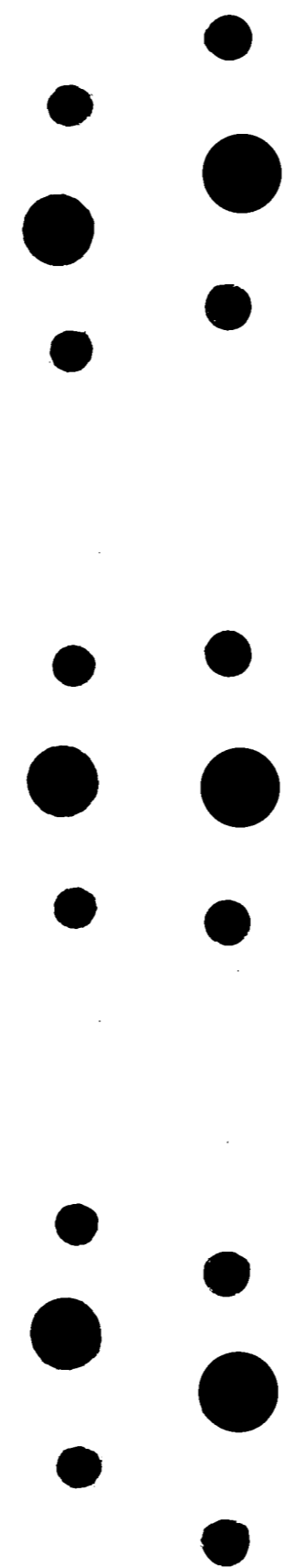

RIGHT SIDE CONSOLE
FIG. 1-7

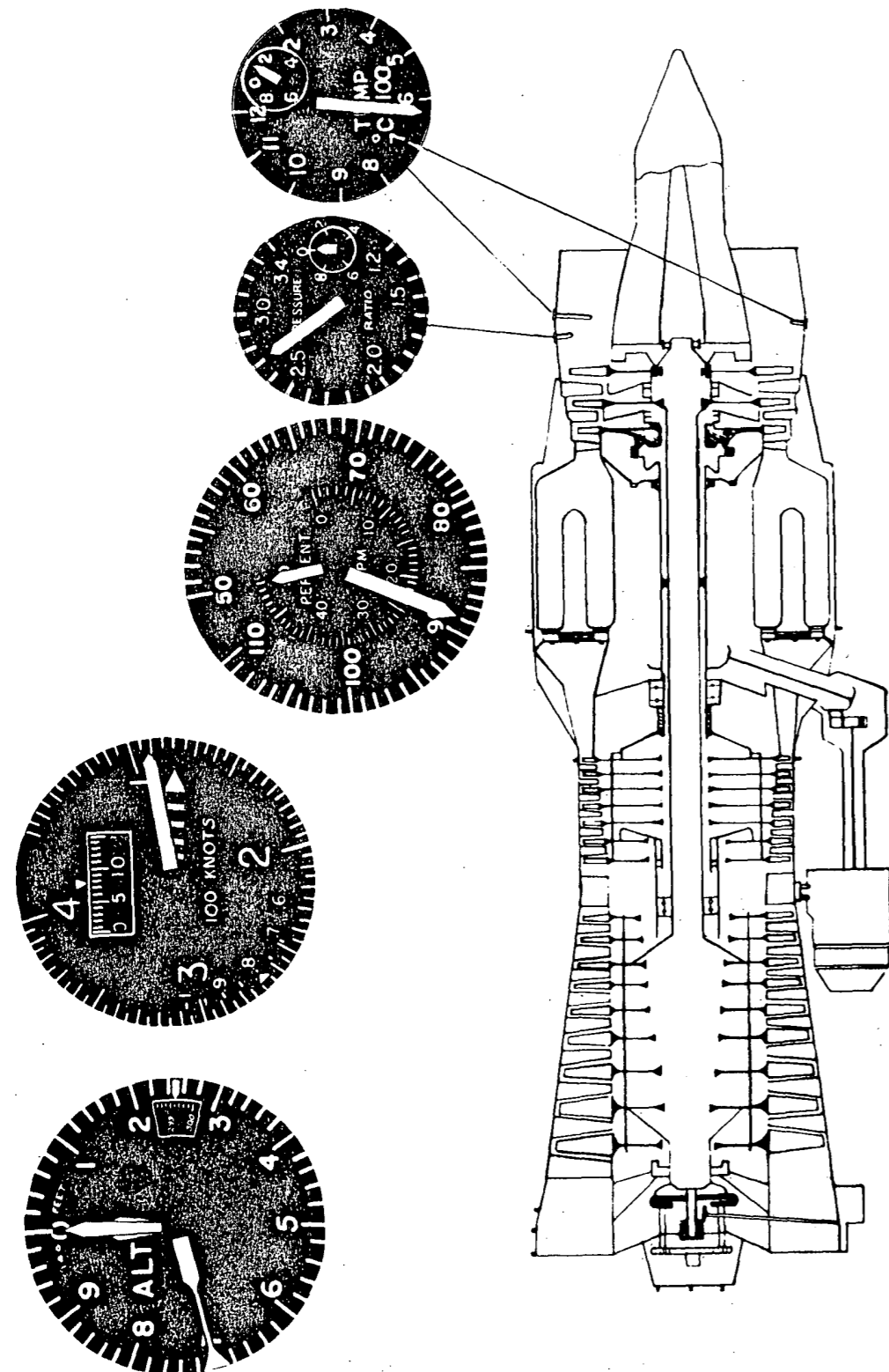

FUNDAMENTAL ENGINE INSTRUMENTATION

FIG. 1-8

~~SECRET~~COMPRESSOR BLEED VALVE

An overboard intercompressor bleed valve is provided on the left side of the engine. This valve serves to facilitate starting, to improve acceleration, and to prevent surge by ducting low pressure compressor air overboard during low power operation. This interstage bleed is required at low power because the low pressure compressor provides a greater mass of air in this power range than the high pressure compressor can handle. This air, if not bled overboard, may build up a high interstage pressure and stall the low pressure compressor. However, at the higher altitudes the bleed valve should not open under any circumstances since the slightest disturbance in the air flow pattern will probably cause flame out. The pilot has no direct control of this valve which is actuated by the bleed valve governor mounted on the front of the engine. The valve is spring loaded to the closed position, and remains closed during engine starts up to 30-35% RPM. It then begins to open and is fully open at idle RPM. On the ground and at low altitude the valve should close at an engine speed of 78-82% upon increasing power.

An indicator light is located on the right upper instrument panel to warn the pilot if the valve should remain open during normal flight. A high altitude mission using the P-37 engine should not be continued above 63,000 feet in case of valve malfunction. Flame out may result above this altitude if the valve remains open. Operation of the P-31 engine at high altitude is not as critical to bleed valve malfunction as the P-37. Also, the spring loading of the valve to the closed position greatly reduces the possibility of its opening at altitude and causing a flame out on either model engine.

ENGINE INSTRUMENTSPRESSURE RATIO

This instrument indicates the ratio of turbine discharge pressure to free stream total pressure. The free stream pressure is the

equivalent of compressor inlet total pressure. This ratio is an indication of thrust and is a very useful engine operating parameter. The pressures are compared by a computer transmitter which electrically transmits the indication to the cockpit. Inverter power is necessary for operation of this system.

TACHOMETER

The tachometer indicates percent of rated high pressure rotor speed. 100% engine speed is equal to 9976 RPM. However, the J57 engine is thrust rated, and "Military" thrust is usually obtained at different RPM's for different engines. Generally, the indicated RPM for "Military" thrust is about 94% for the P-37 and about 96% for the P-31. The RPM should normally be used as a secondary indication of engine output except that for certain altitude ranges it is the primary variable for the P-37 engine. It also should be monitored for overspeeding (102% maximum allowable) and for starting.

EXHAUST GAS TEMPERATURE

This instrument indicates the turbine discharge temperature in degrees Centigrade. A self-balancing potentiometer type system is used, resulting in a very accurate and readable indication. A test button is located near the indicator which drives the needle to the upper limit of the gage. At high altitude this measurement is used to indicate maximum engine power. Inverter power is required.

FUEL PRESSURE

This instrument shows the fuel pressure into the low pressure engine fuel pump and provides an indication of the output from the airplane boost pump. The pressure will vary from 14 to 21 psi. At take-off power, it may momentarily drop as low as 8 psi. This system is inverter powered and remote indicating.

~~SECRET~~

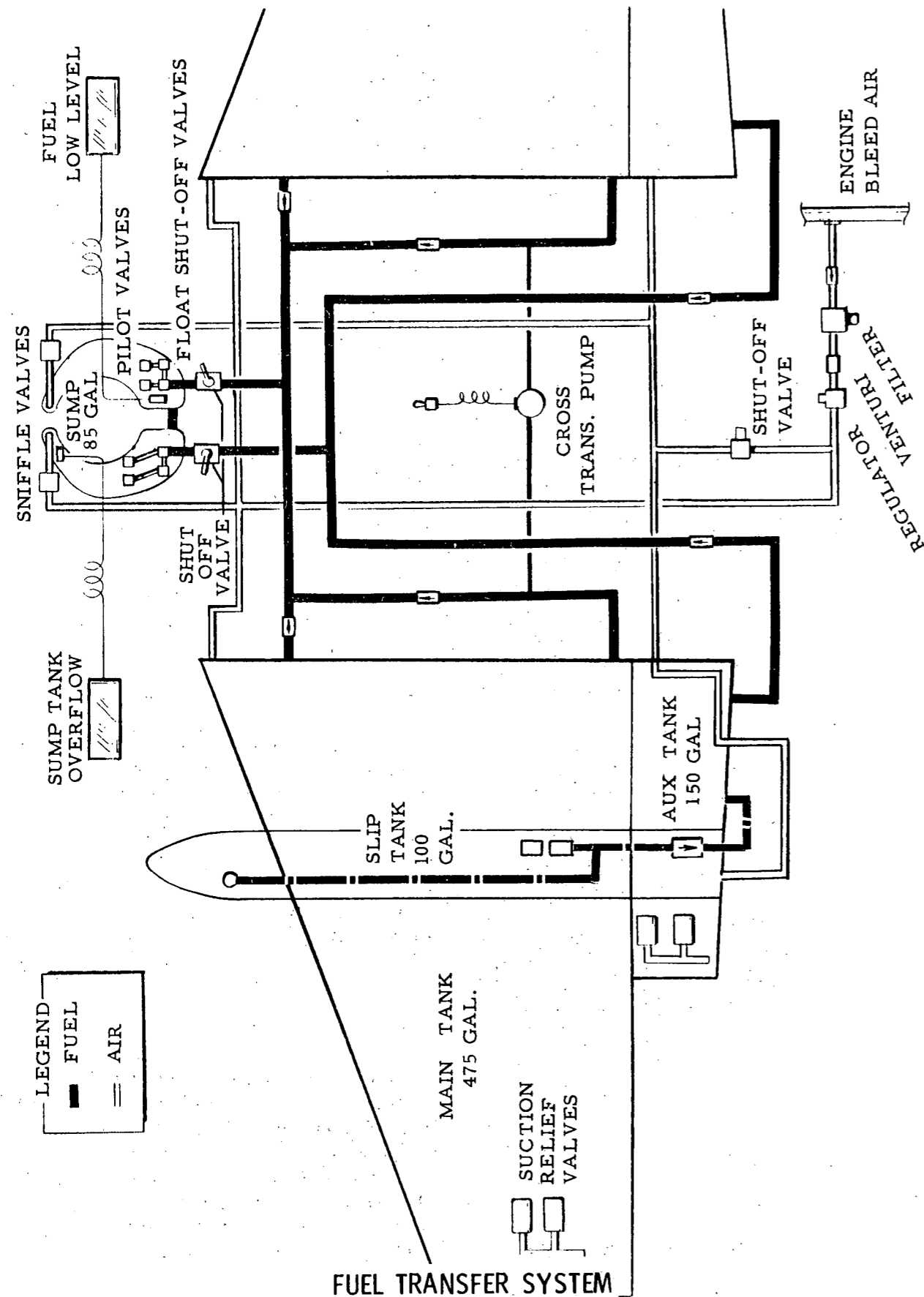

FUEL TRANSFER SYSTEM

FIG. 1-9

OIL PRESSURE

This instrument indicates the engine oil pump discharge pressure. The normal range is 40 to 50 psi. This system is inverter powered and remote indicating.

AIRPLANE FUEL SYSTEM

GENERAL

The airplane fuel system is very simple and requires little attention from the pilot other than occasional checking of the boost pump fuel pressure, the fuel quantity indicator, and the fuel level warning lights.

FUEL TRANSFER SYSTEM

The airplane has four integral wing tanks and a fuselage sump tank into which the wing tanks feed, as shown in Figure 1-9. The main (forward) wing tanks hold 475 gallons each, the auxiliary (aft) wing tanks hold 150 gallons each and the sump tank holds 85 gallons, for a total of 1335 gallons. Fuel from the wing tanks flows into the sump tank by gravity and air pressure feed. The wing tanks are pressurized by engine compressor bleed air to a regulated pressure of one and one half psi. The main wing tanks feed into the right hand side of the sump and the auxiliary tanks feed into the left hand side of the sump. The fuel level in the left and right sides is equalized by a large cross-over line.

Two sets of float valves are provided in the sump tank to control the transfer sequence and maintain proper sump tank fuel level. One set of floats, located slightly above the second set, causes the auxiliary wing tanks to feed first in order to give favorable airplane center of gravity travel. After the auxiliary tanks are empty, the sump tank fuel level drops slightly and the second set of float valves begins to control the sump tank fuel level by transferring fuel from the main wing tanks. This slight drop in sump tank fuel level also operates a float switch which cuts off the supply of engine air to the

auxiliary tanks. Float valves are provided in sets of two to prevent a single stuck valve from blocking the flow of fuel.

SLIPPER TANK INSTALLATION

External fuel tanks, known as slipper tanks, are provided on some airplanes. These tanks are external pods that slip on over the leading edge of the wing approximately ten feet out from the fuselage. Each tank holds 100 gallons, which increases the total fuel capacity to 1535 gallons. Fuel from the slipper tanks is forced by air pressure into the auxiliary (aft) wing tanks. From here it feeds into the sump tank through the normal auxiliary tank transfer system.

FUEL QUANTITY TABLE

Tanks	Pounds	Gallons
Sump	559	85
Main	6,251	950
Auxiliary	1,974	300
Full Internal	8,784	1,335
Slippers	1,316	200
Full With Slippers	10,100	1,535

CROSS TRANSFER PUMP

In order to provide a means of correcting wing heaviness due to uneven fuel feeding, a small 5 gallon per minute electric fuel pump is installed. The reversible pump is controlled by a three position switch located on the left forward subpanel below the landing gear handle. It transfers fuel from either main wing tank to the other. Pushing the switch to the left transfers fuel into the left main tank and vice versa.

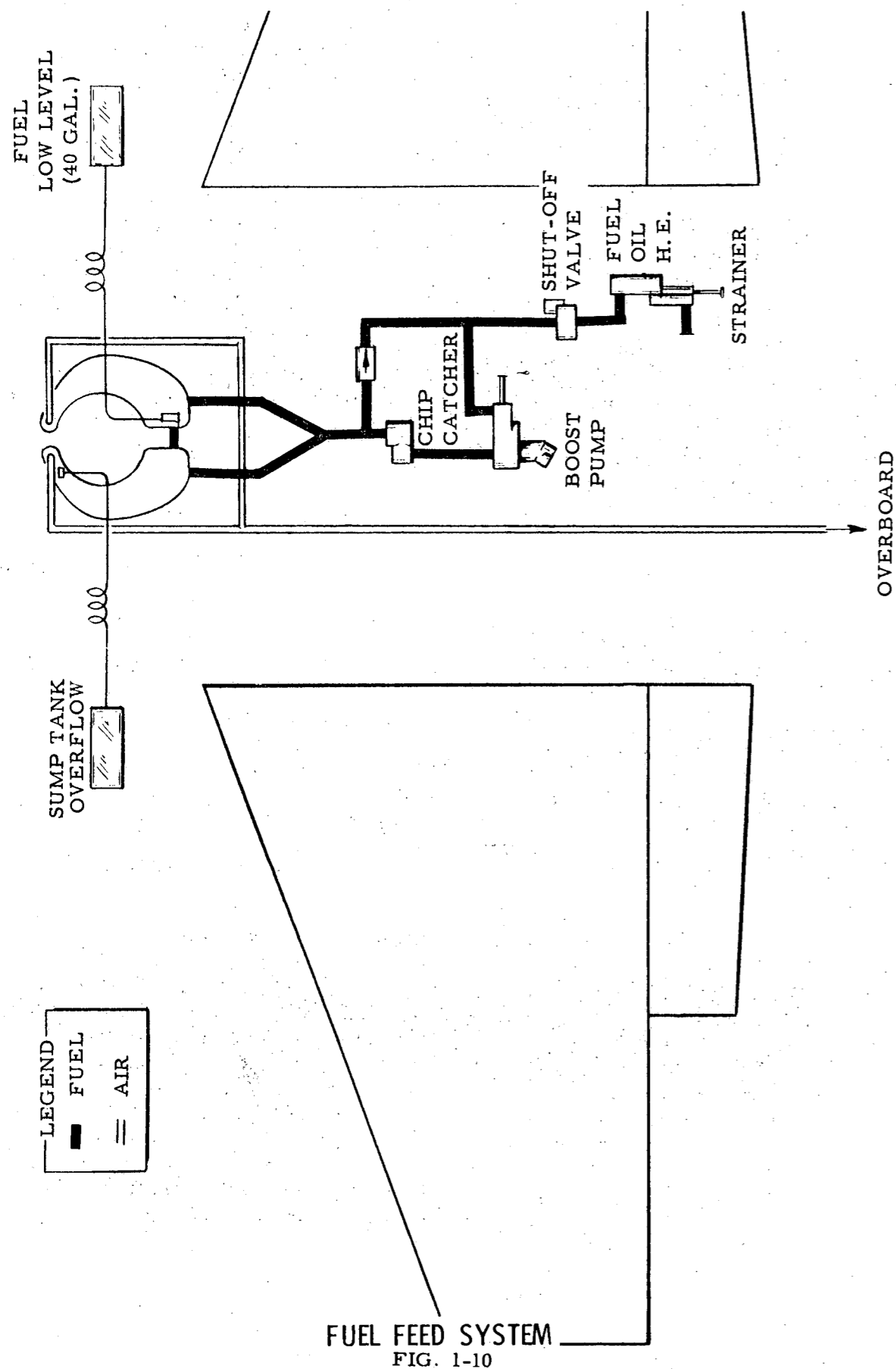
FUEL FEED SYSTEM
FIG. 1-10

SECRET

FUEL GRADE

The airplane fuel system is designed for low vapor pressure type fuel, and fuel loss through boiloff or vent line slugging is negligible. Fuel corresponding to MIL-F-25524A is presently designated as the primary fuel. In addition, fuel specified as LF1A or JP-5 may be used without any restriction.

Precautions must be exercised when using any other fuel due to the special characteristics of the system. JP-4 grade fuel can be used for low altitude operations and for ferry flights. Range and general operating characteristics are unchanged; however, the rate of climb must be restricted to approximately 2000 feet per minute and the maximum altitude to 50,000 feet. Failure to observe these maximums will result in dangerously high pressure in the wing tanks and loss of fuel over-board through the vent system.

No fuel other than those mentioned above may be used.

FUEL LEVEL WARNING LIGHTS

Two fuel level warning lights are located on the right center of the instrument panel. The upper amber light is called the "SUMP OVERFLOW" light and indicates whenever the sump tank is within 6 to 8 gallons of full. The light will be on after servicing of the sump tank and will go out after the engine uses 6 to 8 gallons of fuel. If the light should come on during the remainder of the flight, it indicates that the sump tank fuel level is above normal.

Located directly below the amber light is the red low level warning light. When this light comes on it indicates that the level in the sump tank has dropped to 40 gallons remaining.

CHIP CATCHER

Fuel from the two sides of the sump feed into a common line and into the chip catcher as shown in Figure 1-10. This unit is equipped with a screen which prevents metal chips

and other foreign material from entering the airplane boost pump and the rest of the fuel system. The flow pattern inside the chip catcher is so devised that all fuel is strained through the screen in normal operation. However, if the screen should ice up the fuel will flow through an unscreened opening with no interruption.

FUEL BOOST PUMP

The boost pump is hydraulically driven and is not controllable from the cockpit. It furnishes fuel to the engine at a regulated pressure of 14 to 21 psi. A bypass around the boost pump is provided in the event of pump failure or hydraulic system failure. The engine driven fuel pump will draw enough fuel through the bypass to run the engine up to an altitude of approximately 55,000 feet.

FUEL SHUTOFF VALVE

An electrically operated shutoff valve is located in the main feed line downstream of the boost pump. This valve is for emergency use in case of fire or for engine shut down in case of an inoperative throttle. A guarded switch is provided on the left hand console. The valve is open when the guard is down.

FUEL-OIL HEAT EXCHANGER

In order to prevent any tendency for ice formation in the strainer, the fuel is warmed by a fuel-oil heat exchanger to a temperature of 70 degrees F. This unit is thermostatically controlled and the amount of oil passing through is varied as necessary. Some oil cooling also takes place in the heat exchanger since the fuel is warmed by heat rejection from the oil. From the heat exchanger the fuel passes through a wire mesh strainer and into the engine fuel pump.

FUEL QUANTITY COUNTER

A positive displacement type flowmeter is located in the engine high pressure fuel

SECRET

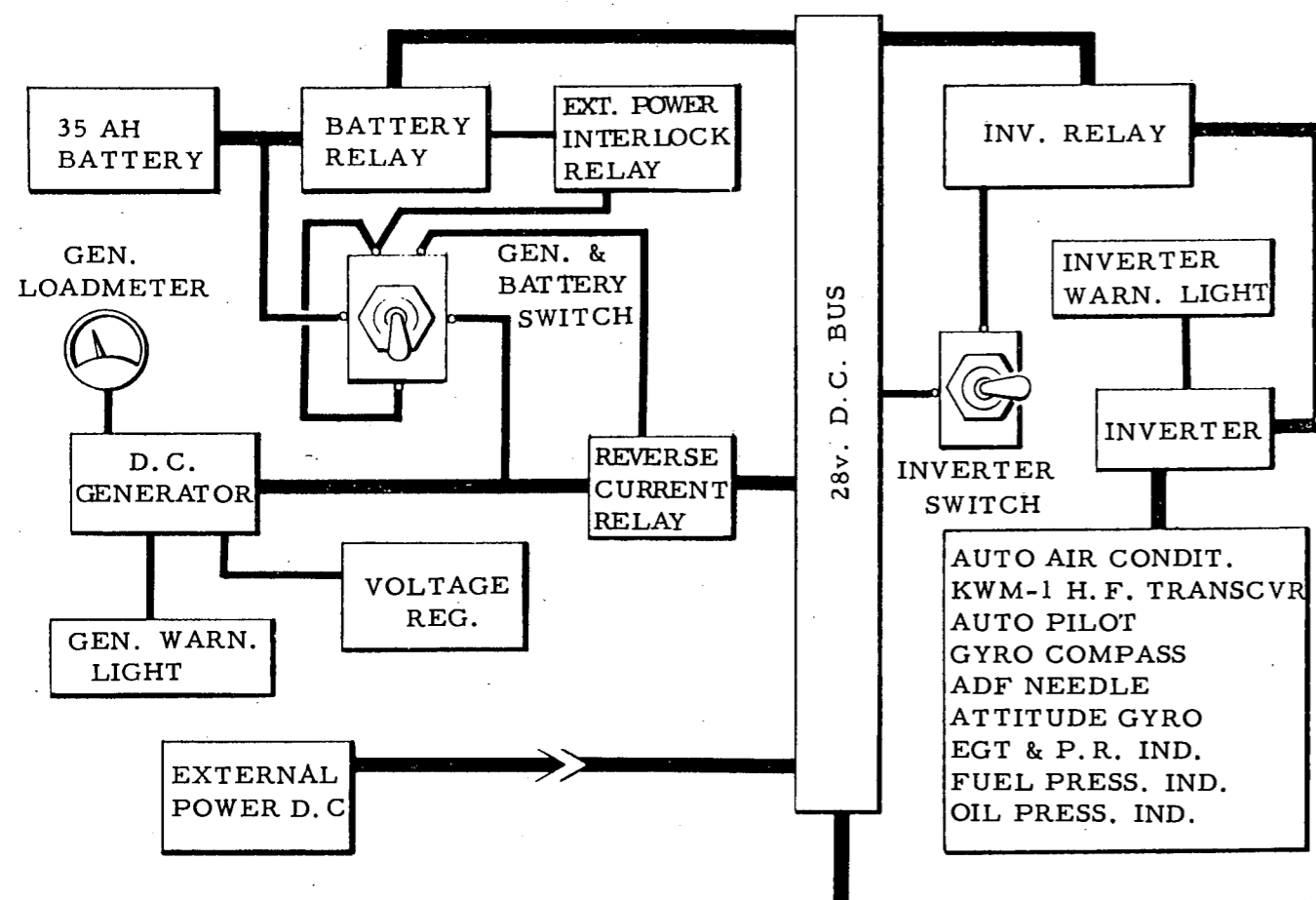

WING FLAP CONTROL
LANDING GEAR CONTROL
SPEED BRAKE CONTROL
AILERON SHIFT ACTUATOR
AILERON TRIM TAB ACTUATOR
ELEVATOR TRIM TAB ACTUATOR
WING FLAP POSITION INDICATOR
LANDING GEAR POSITION INDICATOR
LANDING GEAR WARNING
FIRE WARNING
WARNING LIGHTS
COCKPIT LIGHTS
LANDING LIGHTS
ANTI-COLLISION LIGHTS
FACE HEAT
EMERGENCY FACE HEAT
AIR CONDITIONING - MANUAL
FUEL SHUT-OFF
EMERGENCY FUEL CONTROL
FUEL QUANTITY COUNTER
ENGINE START

PITOT HEAT
F. A. T. INDICATOR
GYRO COMPASS
ARN-6 RADIO COMPASS
ARC-12 V. H. F. TRANSCEIVER
ARC-34 U. H. F. TRANSCEIVER
KWM-1 H. F. TRANSCEIVER
ARA-26 KEYER
AUTO PILOT
DRIFT SIGHT
HATCH WINDOW HEATERS
TRACKER CAMERA
CAMERA EQUIPMENT -A, A₂ & B.
APQ 56
RADAN
WEATHER EQUIPMENT
SYSTEM I, III, & IV
F-2 HATCH
AFWSP NOSE
AIR SAMPLER
DESTRUCTOR

ELECTRICAL POWER DISTRIBUTION

FIG. 1-11

system. This unit counts the gallons of fuel used by the engine whether operating on the normal or emergency fuel system. A subtractive counter mounted on the instrument panel shows the gallons remaining in the aircraft. The fuel quantity counter and the low level warning lights are the only fuel quantity indicators.

TANK VENT SYSTEM

All wing tanks are vented into the sump tank through combination type suction and pressure relief valves. The top of the sump tank is vented to the outside air at the top trailing edge of the vertical fin. Dual suction relief valves are located in the outboard end of each wing tank to prevent negative pressures from developing during rapid descents.

ELECTRICAL SYSTEM

GENERAL

The direct current electrical system is a regulated 28 volt, single wire type which utilizes the airframe structure for the ground return. D-C power is furnished by one 400 amp, 28 volt engine-driven generator. A hermetically sealed, 35 ampere-hour, nickel-cadmium battery is installed to supply emergency power to the main bus.

The alternating current system power is furnished by a three phase, 115 volt, 400 cycle inverter located in the equipment bay and operated from the 28 volt D-C bus.

A schematic of the direct current and inverter power distribution is shown in Figure 1-11.

An engine-driven alternator is mounted on the front accessory case and is used to power certain military equipment. The alternator is rated at 3.3 KVA, 208/120V, three phase, 400 CPS. A schematic of the alternator power distribution system is shown in Figure 1-12.

EXTERNAL POWER RECEPTACLE

For ground operation two external power receptacles are provided on the left side of the fuselage near the leading edge of the wing. One receptacle is for 28 volt D-C power and the other is for 208/120 volt, three phase, A-C power. When external D-C power is connected, the ship's battery is automatically cut off the line, regardless of the position of the generator-battery switch. However, this is not true of the generator which may come on if the external voltage supply is low and the switch is in the generator and battery position.

GENERATOR AND BATTERY SWITCH

The generator-battery control is a three position switch located on the lower left instrument sub-panel. Center position is OFF. Up position, GEN. & BAT. on, is the normal operating position. Down position is BAT. only on. When the generator is not on the line due to low engine speed, or other cause, the battery is still on with the switch in the GEN. & BAT. position.

GENERATOR LOADMETER

The loadmeter indicator is located on the right lower instrument sub-panel. This instrument is an ammeter which has been calibrated to read 0.1 to 1.25 times the generator rated output. However, the electrical load requirements are not designed to use the rated output of the generator due to altitude restrictions on output. Therefore, full generator load is considered to correspond to a reading of approximately 0.4 on the loadmeter. Normally, the indication will be about 0.1.

GENERATOR OUT WARNING LIGHT

This red warning light, located just above the generator-battery switch, glows whenever the generator is inoperative and the D-C bus is energized either by the battery being selected or by external power.

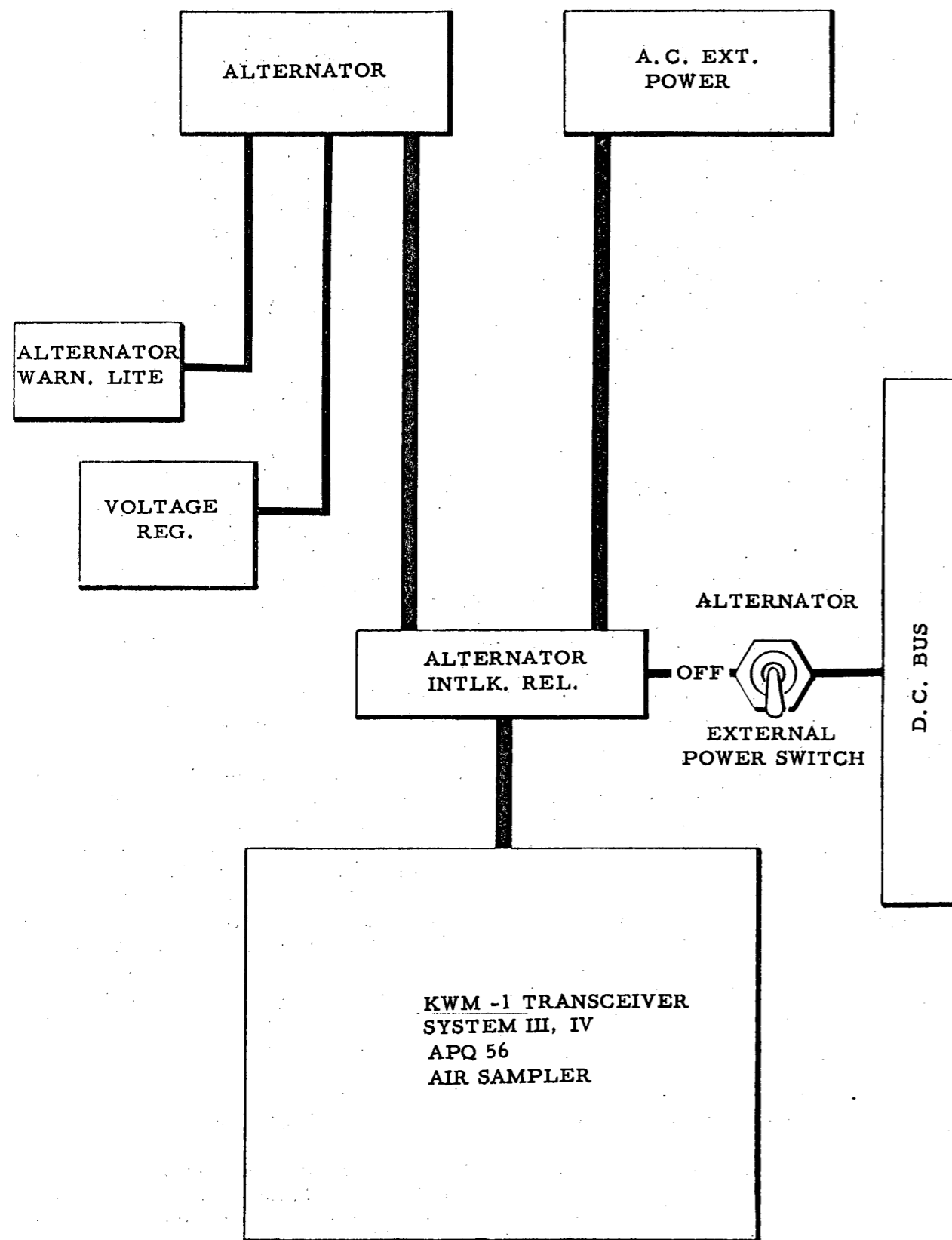

ALTERNATOR POWER DISTRIBUTION

FIG. 1-12

INVERTER SWITCH

The A-C inverter power is controlled by a two position ON, OFF switch located on the lower left instrument sub-panel near the generator-battery switch.

INVERTER OUT WARNING LIGHT

This red warning light located just above the inverter switch, glows whenever the inverter is inoperative or turned OFF.

A-C ALTERNATOR SWITCH

Alternator power is controlled by a three position switch located on the lower left instrument panel. Center position is OFF. Up position, A-C alternator ON, is the normal operating position. Down position is for external operating power.

A-C ALTERNATOR OUT WARNING LIGHT

This amber warning light, adjacent to the A-C alternator switch, is OUT during normal operation of the alternator. The light comes ON to indicate low bus voltage. In the event of low bus voltage during normal flight power settings, the A-C alternator switch should be put in the OFF position, thus putting the warning light OUT.

NOTE

During low RPM conditions, such as before take-off and during the landing pattern, the A-C alternator OUT light will be on. This is normal and no corrective action should be taken.

HYDRAULIC SYSTEM**GENERAL**

The hydraulic system as shown in Figure 1-13 operates the landing gear, speed brakes, wing flaps and fuel boost pump drive motor.

There is no emergency hydraulic system. A separate hydraulic system is provided for the main wheel brakes.

This system is a constant 3000 psi pressure type, incorporating an accumulator and self-regulating engine-driven pump. The air charged accumulator stores pressure for peak demands and thus reduces fluctuation in pump loading. The system relief valve serves as a safety device to bypass oil back to the tank and prevent excessive system pressure.

The hydraulic oil is cooled by passing it through a heat exchanger located in the engine oil ram air cooling scoop on the lower right side of the fuselage.

Engine compressor bleed air is used to pressurize the hydraulic fluid reservoir to reduce foaming and increase pump efficiency at high altitude.

HYDRAULIC PRESSURE GAGE

This instrument located on the right side panel indicates the hydraulic system pressure.

FLIGHT CONTROL SYSTEM**GENERAL**

The flight controls are conventional, consisting of rudder pedals and a wheel mounted on a control column. All surfaces are directly connected to the cockpit controls by cables and no power boost is provided.

Electric trim is provided in pitch and roll. There is no cockpit directional trim. However, with auto pilot operating, there is effective yaw trim.

There are no surface locks except as provided by the ground crew.

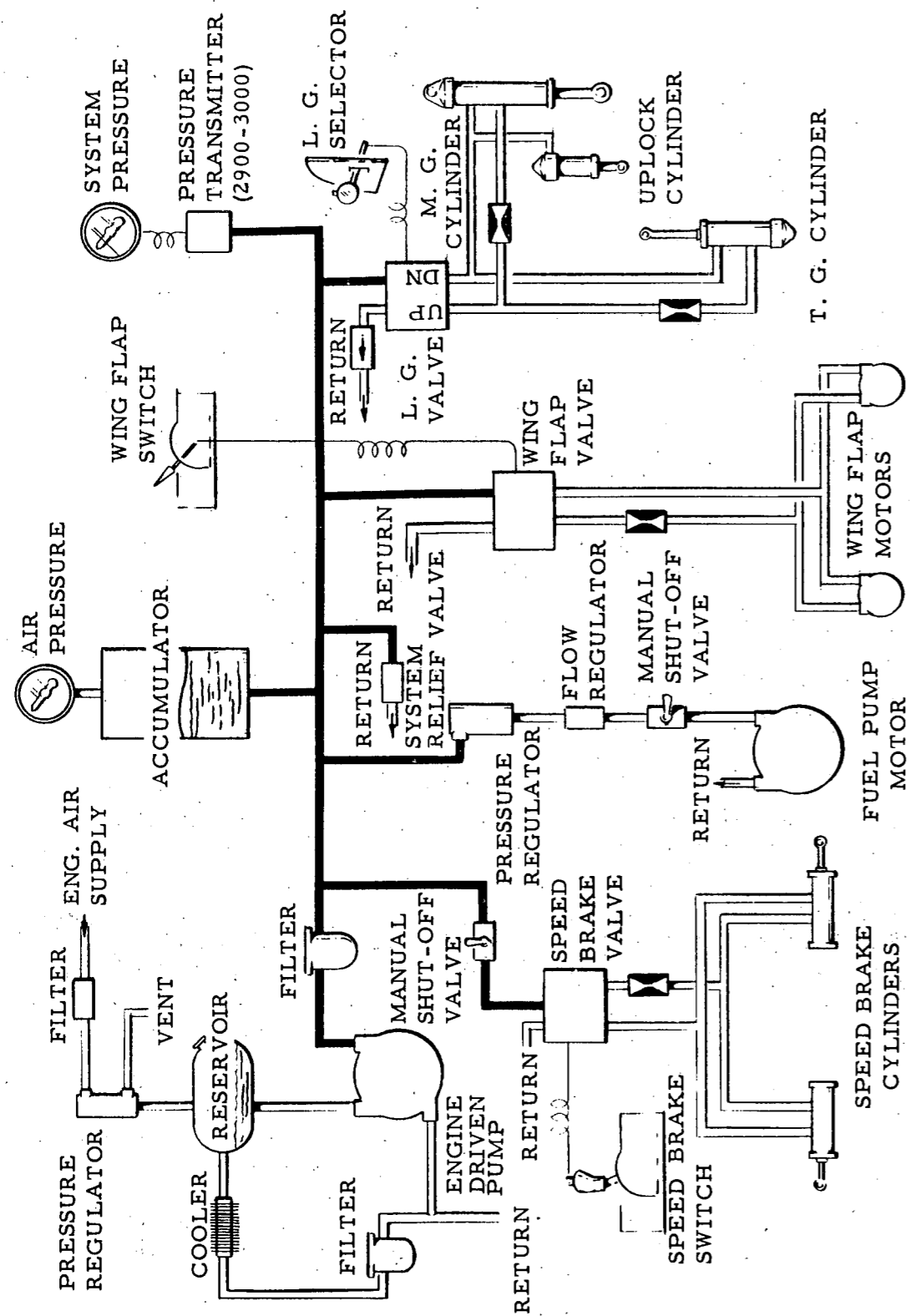

HYDRAULIC SYSTEM DIAGRAM

FIG. 1-13

SECRET

GUST CONTROL

The most unique feature of the flight control system is the gust control. This device makes it possible to simultaneously shift both ailerons and wing flaps to an up position. This is called the "Gust" position. Ailerons are shifted 10 degrees and flaps are shifted 4 degrees. This has the dual purpose of reducing both wing and tail structural loads. The gust control is used to shift the surfaces up when flying in turbulent air or when flying at higher speeds in smooth air. The aileron motion is effected by an electric shifting mechanism located under the cockpit floor. The wing flaps are moved by their usual hydraulic motors. The gust control switch is located on the left console aft of the throttle. A dual amber light is provided on the left side of the instrument panel to indicate that the ailerons and flaps have shifted up. The lights glow when the aileron actuator and flaps have reached the gust position. In addition, the wing flap position indicator shows the flaps are shifted up.

CONTROL WHEEL

The control wheel has several switches installed. On the right hand grip is the elevator trim tab control switch and the autopilot disengage button. On the left hand grip is the trim tab power switch and a radiomic button. All trim tab actuator power, including the automatic pitch trim unit of the autopilot, goes through the trim power switch.

AILERON CONTROL SYSTEM

The ailerons are controlled through rotation of the wheel. Surface travel is 16 degrees up and 14 degrees down. With actuation of the gust control, these travels are reduced to 6 1/2 degrees up and 5 degrees down from the shifted neutral position. The electrically actuated trim tab is located on the left aileron. The trim tab switch is located on the left console.

ELEVATOR CONTROL SYSTEM

The elevator system is conventional with column control. Surface travel is 30 degrees up and 11 1/2 degrees down. The electrically actuated pitch trim tabs are located at the inboard end of each elevator. The control switches are located on the wheel. In addition to electric trim operation, the tabs have automatic servo operation to reduce longitudinal control forces.

RUDDER CONTROL SYSTEM

The rudder control system is conventional with pedal controls. Surface travel is 30 degrees left and right. A ground adjustable bend tab is installed on the rudder.

The rudder pedals may be adjusted fore and aft to accommodate different leg lengths. The adjustment lock lever located on the outboard side of each pedal can be released by outboard toe pressure.

CAUTION

There is no rudder centering in this system. Care must be exercised that the rudder is neutral when the pedals are aligned. If necessary, have ground personnel hold the rudder in neutral.

WING FLAPS

GENERAL

The wing flaps are actuated by two hydraulic motors which are interconnected by a flexible shaft. If one motor should fail, the other motor will operate both flaps at a slower speed.

A second function of the interconnecting shaft is to maintain synchronization of left and right flap positions. If the left and right flaps should become unsynchronized for any reason, this condition is limited to

a maximum of 5 degrees by an automatic switch device. This safety feature precludes the possibility of large differences in flap position due to malfunction or failure. After the cutout switch has been actuated, it is no longer possible to move the flaps until reset on the ground.

There is no emergency method of operating the wing flaps.

WING FLAPS CONTROL

An electric solenoid valve is used to control the hydraulic fluid flow to the hydraulic drive motors. This valve is controlled by the flap switch located on the left console outboard of the throttle. This switch has three positions; OFF, UP and momentary DOWN.

NOTE

The gust control switch over-rides the wing flap switch. Thus the wing flap switch is inoperable with the gust control in the UP position.

WING FLAP POSITION INDICATOR

The wing flap position indicator is located on the left lower side of the instrument panel. It has a range from minus 4 degrees to plus 35 degrees, which coincides with the maximum flap travel. This is an electric instrument operating from D-C power.

SPEED BRAKES

GENERAL

The speed brakes are a drag increasing device used to decrease speed. The two flaps are located on the aft sides of the fuselage and have a maximum deflection of 50 degrees. The direction of travel may be reversed at any time.

SPEED BRAKE CONTROL

The speed brake control is a three position center-off slide switch located on top of the throttle lever. The hydraulic fluid flow to the actuating cylinders is solenoid valve controlled. To OPEN the speed brakes, the switch is pulled back; to CLOSE, the switch is pushed forward. The speed brakes may be stopped in any position on either the extension or retraction cycle by returning the switch to its CENTER-OFF position. However, air loads may slowly close the speed brakes from any partially open position if the switch is positioned CENTER-OFF. This will not occur with the switch in the OPEN position. In the event of engine failure, normal engine windmilling will develop sufficient hydraulic pressure to actuate the speed brakes.

LANDING GEAR

GENERAL

The airplane is equipped with a hydraulically actuated bicycle landing gear which is controlled by a lever located on the left forward side panel. Both main gear and tail gear have dual wheels and retract forward. Lateral balance is provided by left and right droppable auxiliary gears located outboard on the wing. An electrically operated indicator and warning system is provided for the main and tail gears only. An emergency drop system is provided to extend the main and tail gears in case of failure of the normal system.

EMERGENCY EXTENSION SYSTEM

This is a free fall system. Both the main and tail gear are mechanically released by a cable system, which is connected to the emergency gear release handle located on the lower center sub-panel. Gravity and free stream air pressure force the gear to the down position. After the gear is in the down position, the gear is mechanically locked in place by a spring loaded downlock mechanism.

LANDING GEAR CONTROL LEVER

The landing gear is controlled by a lever located on the left forward side panel. This lever actuates switches that operate an electric solenoid valve which diverts the hydraulic fluid to the landing gear cylinders. The lever is retained in the down position by a solenoid lock which is controlled by a scissors switch on the main landing gear. For gear retraction in flight, the lock is automatically released and there are no additional spring buttons to release. For emergency gear retraction with the airplane weight on the gear or in case of solenoid lock malfunction in flight, the lock can be manually released by pressing the red button immediately above the landing gear lever.

For gear extension it is necessary to release a spring loaded latch by means of thumb pressure on the small button protruding from the lever before placing the lever in the DOWN position.

LANDING GEAR WARNING SYSTEM

The gear unsafe warning red light is located in the translucent end of the gear control lever. It glows whenever the landing gear is not locked in the position selected by the control lever.

The gear unsafe warning horn sounds whenever the throttle is retarded below the position for 75 to 80% engine speed, and the landing gear is not down and locked. The unsafe warning light will also glow in this event. The warning horn cutout button is provided directly inboard of the throttle to silence the horn when desired; however, the throttle switch will be automatically reset each time the throttle is advanced.

LANDING GEAR POSITION INDICATOR

The landing gear position indicator is located on the upper left side of the instrument panel and shows the position of each individual landing gear. When the D-C electrical bus is not energized, diagonal stripes appear in each window. When the bus is energized, a

wheel appears in each window for each gear that is down and locked, and the word UP appears for each gear that is up and locked. If the gear is at any intermediate position, the diagonal stripes appear.

AUXILIARY GEAR

The auxiliary landing gear, known as pogos, will swivel a full 360 degrees and are located outboard on each wing. The pogos are provided for lateral balance during ground handling and for the early part of the take-off run. There is no cockpit control provided and the pogos merely fall out of their sockets as the wings begin to lift. If desired, they can be retained for flight by leaving the safety pin installed.

The pogos can be seen from the cockpit and no indication is provided.

STEERING SYSTEM

The airplane is steerable by means of the tailwheel which has an angular range of 6 degrees each side of center. The pilot controls the steering through the rudder pedals which are directly connected to the tail gear by means of a cable system. When the tail gear is retracted, this system is inactive.

WHEEL BRAKES

The brakes are located on the dual main wheels. They are of the spot and disc type and a dual set is installed on each wheel. The brake system is an independent, manually operated hydraulic system as shown on Figure 1-14. A small reservoir located just forward of the cockpit feeds a single orthodox master cylinder. The brakes are operated by conventional toe pedals. Since there is no differential braking, either or both pedals will operate the single master cylinder. The pressure from the master cylinder is carried to all brakes by means of a pressure manifold. A pressure relief valve limits the maximum brake pressure.

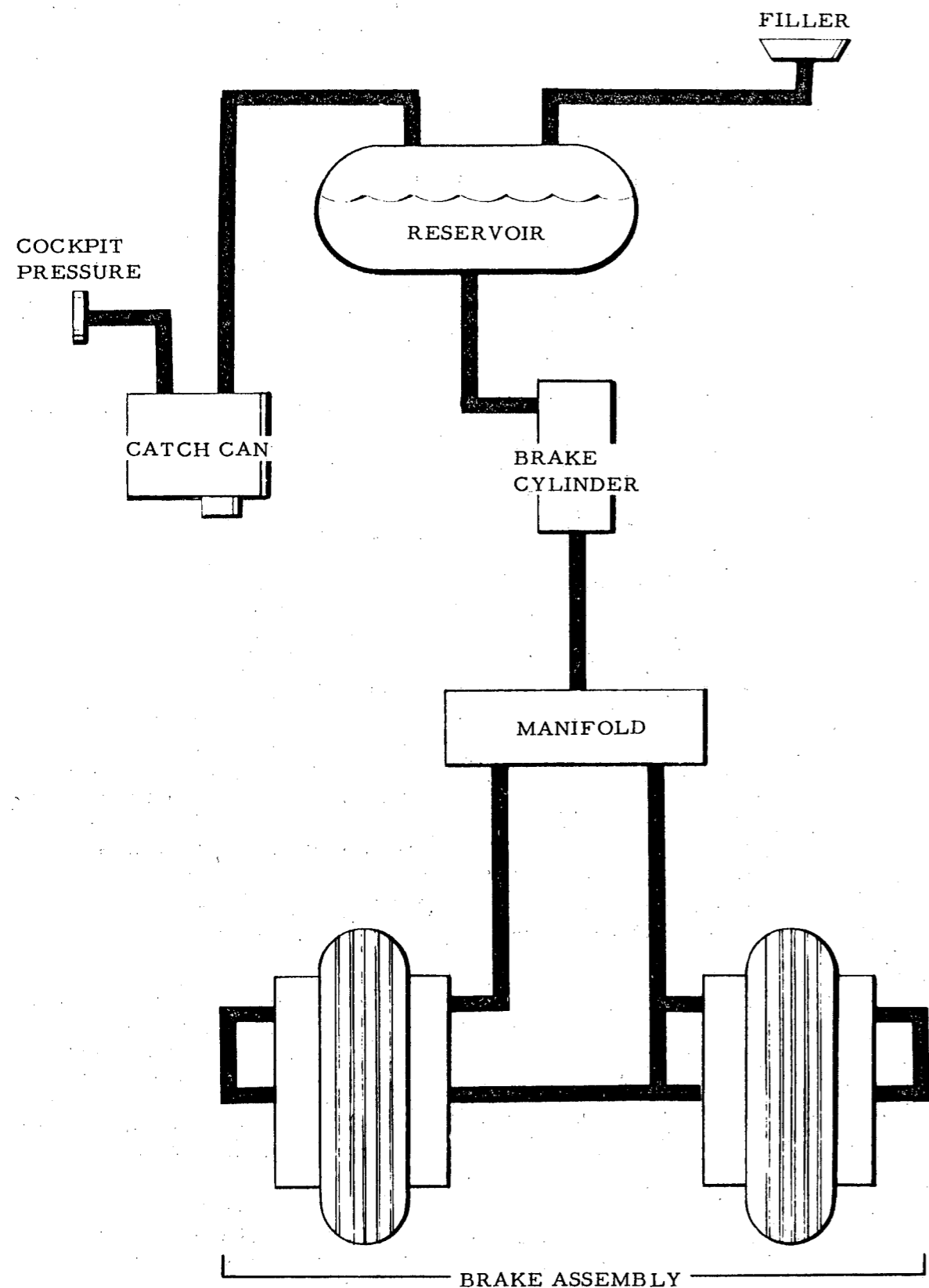

BRAKE DIAGRAM
FIG. 1-14

CAUTION

Do not run the engine above 85% RPM while holding the airplane with brakes alone.

DRAG CHUTE

A 16 foot drag chute is located in a compartment just above the tailpipe nozzle. Operation of the release mechanism is manually controlled by cable from the cockpit. The chute is installed in the compartment with the attaching hook unlocked. This allows the chute to leave the airplane in case of accidental opening of the doors during take-off or flight. The chute is operated by a tee handle located on the side of the left console below the throttle. Pulling this handle out against the stop first latches the hook and then allows the chute to deploy. Rotating the handle 180 degrees clockwise and pulling out further unlatches the hook and allows the chute to jettison.

If the drag chute is deployed in normal flight, it will not stay intact but will soon disintegrate due to engine jet stream effects. Even on take-off or go-around it is not a drag problem since it won't stay on very long.

INSTRUMENTS

Those instruments which are not properly a part of a complete system are covered below.

AIRSPEED INDICATOR

A conventional 40 to 400 knot airspeed indicator is located on the upper left side of the instrument panel. The instrument has two pointers which indicate both the actual airspeed and the maximum allowable airspeed reading at the same time. The outer dial is graduated in 5 knot increments. A rotating drum, visible through a window in the dial, is graduated from 0 to 100 in 2 knot increments

for more accurate indication.

The maximum allowable airspeed pointer shows maximum structural speed or the airspeed corresponding to limit Mach number, whichever speed is less. Below about 37,000 foot altitude the hand will indicate the limit indicated airspeed of 260 knots. Above 37,000 feet, the hand will indicate lower airspeeds corresponding to limit Mach number of 0.80.

ALTIMETERS

Two sensitive altimeters are installed in the cockpit. They are of conventional type with a range from zero to 80,000 feet. The 10,000 foot pointer has a special notched disc and a pointer extension for better readability. A striped section warning indicator appears through the notched disc at altitudes below 16,000 feet.

The airplane altitude is shown by the altimeter located on the left side of the instrument panel.

The second altimeter is located on the right forward side panel. By means of a manual selector valve located above the right aft console, the instrument will read either cabin altitude or equipment bay altitude.

VERTICAL SPEED INDICATOR

The vertical speed indicator is conventional and shows the rate at which the airplane is climbing or descending, based on the rate of change of atmospheric pressure. The dial is graduated from zero to 6000 feet per minute on two adjoining scales.

PITOT STATIC SYSTEM

The pitot static system contains one pitot probe and one pair of static ports. The pitot tube is located on the bottom fuselage center line forward of the cockpit. The static ports are flush in each side of the fuselage skin just forward of the cockpit.

TURN AND SLIP INDICATOR

The turn and slip indicator is a conventional instrument for indicating rate of turn and slip or skid of the airplane. It is located on the left side of the instrument panel. This type indicator is air driven by engine compressor bleed air which is regulated to the proper pressure. The rate of turn indication is inoperative during engine power off conditions.

This is a four minute instrument and gives a 360 degree turn in four minutes for one needle width.

TYPE J-8 ATTITUDE INDICATOR

The attitude indicator is located on the right center of the instrument panel. The pitch attitude of the aircraft is indicated in climb or dive by displacement of the horizon bar with respect to the miniature adjustable airplane. The miniature airplane is above the horizon bar in a climb and below the horizon bar in a dive. The roll attitude of the aircraft is shown by the relation of the bank index to the degree markings on the instrument face.

A "pull to cage" knob is located on the lower right corner of the instrument case. To cage the gyro the knob should be pulled smoothly and gently to avoid damaging the instrument. The gyro may be caged before take off to expedite normal erection. It may also be caged in flight if the aircraft is straight and level, by visual reference to a true horizon.

A knob is provided on the lower left corner of the instrument to adjust the miniature airplane for zero pitch indication. The adjustment can be made for any pitch attitude from 5 degrees dive to 10 degrees climb.

The J-8 indicator is operated on inverter power. If power is off, a warning flag appears on the face of the instrument.

DIRECTIONAL INDICATOR

This instrument combines the indications from the gyrosyn magnetic compass and the radio direction finder (ADF). It is located on the left side of the instrument panel and operates on inverter power.

The gyrosyn magnetic compass indication is provided by the rotating face or card of the instrument. An index mark is located at the top of the instrument and the card rotates in relation to the index to give the magnetic heading. The magnetic flux valve is located in the left wing tip of the airplane and furnishes the actual magnetic heading information. This heading information is furnished to the amplifier and gyro of the MA-1 compass system. This system in turn furnishes the heading information to the pilot's directional indicator. The gyro may also be used as a "free gyro" for navigation in high latitudes. It is necessary for the pilot to manually fast slave the gyro for proper heading when the system is first turned on. The controls are located on the right forward console. A complete explanation of this system will be found in SECTION IV.

The instrument has two pointers which are slaved together since only a single ADF receiver is installed. When the airplane is heading directly toward a station, the needles will point to the index mark at the top of the instrument. The actual magnetic bearing of any station may be read at the needle point on the rotating card.

In order to provide an adjustable lubber line, a movable index is furnished. A control knob is located to the left of the indicator. This movable index can be set to line up with zero on the rotating card for any desired magnetic heading of the aircraft.

MAGNETIC STANDBY COMPASS

The standby compass is located on the upper left instrument panel. This is a standard type to be used as a check on the gyrosyn compass system or for emergency operation.

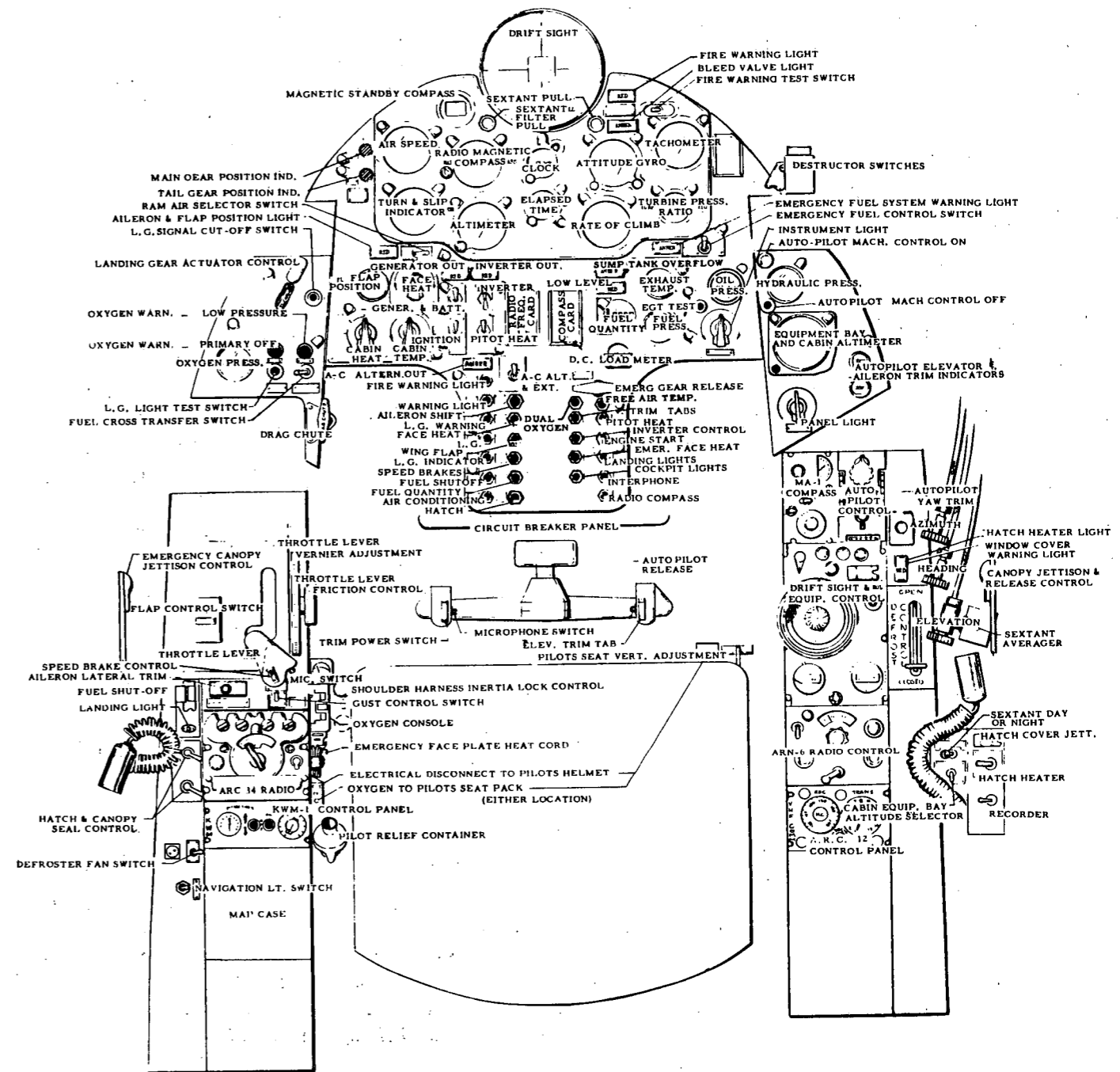

COCKPIT ARRANGEMENT
FIG. 1-15

CLOCKS

Two clocks are provided in the center of the instrument panel. The upper one is an eight day type with stoppable sweep second hand. The lower one is an elapsed time clock with sweep second hand.

FIRE WARNING SYSTEM

A single warning light, located on the right upper instrument panel, is used to indicate both fire and overheat warning. Fire is indicated by a steady light and overheat by a flashing light. The only difference in these two indications is due to location of the sensing devices. Thermostiches are located in the forward engine compartment for the steady light and additional switches are located in the aft fuselage section for the flashing light. These two sections are fully interconnected. Either group of switches could be set off by either fire or overheat. A circuit test switch is located adjacent to the light which checks the complete wiring system up to, but not including, the thermostiches. It has two test positions, one for each circuit.

NOTE

It is possible for the light to come on because of an electrical short circuit.

SPEED WARNING SYSTEM

The speed warning system warns the pilot of excessive speeds for a given gust control configuration. It was necessitated by the rapid accelerating characteristics of the aircraft and the serious structural consequences of excessive speed. The indicated airspeed is monitored by a sensitive pressure switch located in the nose section. If the aircraft is flying with the gust control faired, the warning occurs at 220 knots. The gear warning horn blows and the speed brakes automatically extend. If the aircraft is flying with the gust control in gust, the warning occurs

at 270 knots. In this case, only the gear warning horn blows.

The tolerance of the pressure switch setting permits plus or minus 10 knots variation in the speed at which warning is given. If it is necessary to continue operation at placard speed of 260 knots, the horn can be silenced by pulling the landing gear warning circuit breaker.

For operational reasons, certain airplanes have the speed warning system deactivated. This is normally decided by the local commander.

CANOPY**GENERAL**

The airplane has a single piece canopy hinged on the left hand side. The canopy is raised and lowered manually and has a locking handle on the right hand side. There are three latches in the right hand cockpit sill for locking the canopy. The canopy is locked by pushing up and forward on the handle located on the right hand side of the cockpit.

EXTERNAL RELEASE HANDLE

The external handle is located on the right side of the fuselage near the canopy leading edge. It is normally flush and pops out for use. It can be used for either locking or unlocking the canopy from the outside.

PRESSURE SEAL

A tubular rubber seal is provided to seal the gap between the canopy frame and the cockpit sill and windshield. Engine compressor bleed air, suitably regulated, is used to inflate the seal. It is controlled by a manual valve on the left aft console.

EMERGENCY RELEASE

An emergency release handle, painted red, is located on the left side of the cockpit near the forward edge of the canopy. The initial movement of the handle operates a special valve which dumps the pressure in the canopy seal. This dumps the cabin pressure and materially reduces the handle operating load. Further movement of the handle unlocks the left hand canopy latches. For emergency release or jettison, both left and right handles are simultaneously pulled aft. When released, the canopy is restrained from moving sideways by a tubular structure in the aft end.

SUNSHADE

To combat solar radiation and glare at high altitudes, the aft portion of the canopy glass is painted with white opaque material. The painted area is not normally visible to the pilot due to restrictions of head movement. The forward section of the canopy is provided with a movable sunshade.

PILOT'S SEAT**GENERAL**

The airplane has two types of seats available for installation; an ejection seat and a non-ejection seat. The purpose of the dual installation is to allow a weight saving of 53 pounds by using the non-ejection seat when gross weight is a prime consideration.

EJECTION SEAT

The ejection seat is a simple lightweight design using a "low g" catapult to minimize the possibility of ejection injury. The seat has no adjustment provisions. Pilot position in the seat is adjusted by use of balsa wood blocks. A shoulder harness lock and release lever is located on the left hand side. The ejection seat is equipped with an automatic release seat belt. There are no armrests on the seat and ejection is performed

by pulling up on a "D" ring located at the front of the seat between the pilot's legs. See Figure 1-16.

Pulling the "D" ring actuates an M3 initiator which starts the ejection cycle. The first initiator provides gas pressure to disconnect the elevator control and stow the wheel forward to clear the pilot's knees and feet. It also actuates an M6 initiator. The M6 initiator has a two second delay before simultaneously locking the shoulder harness, actuating an M4 catapult and an M6 initiator to release the seat belt. The M4 catapult imparts a maximum of 9g acceleration to a 325 pound seat-man. This is sufficient to clear the vertical fin by 7 feet at 260 knots. The 2 second delay in the seat belt release system allows the seat to be well clear of the airplane prior to opening of the belt.

One safety pin is provided in the M3 initiator on the right hand side of the seat pan. This must be removed for the seat to fire.

NON-EJECTION SEAT

The non-ejection seat is a plain type and is wider than conventional to allow more pilot comfort. A manually operated seat belt is installed on this seat. A shoulder harness lock and release lever is located on the left hand side of the seat. This seat may be adjusted vertically by releasing the latch with the lever on the right lower side of the seat. The seat is spring loaded in the up direction and should be occupied when adjustment is made.

AUXILIARY EQUIPMENT

The following equipment and its operation is described in SECTION IV, DESCRIPTION AND OPERATION OF AUXILIARY EQUIPMENT:

Air Conditioning and Pressurization System

Windshield and Canopy Defrosting System

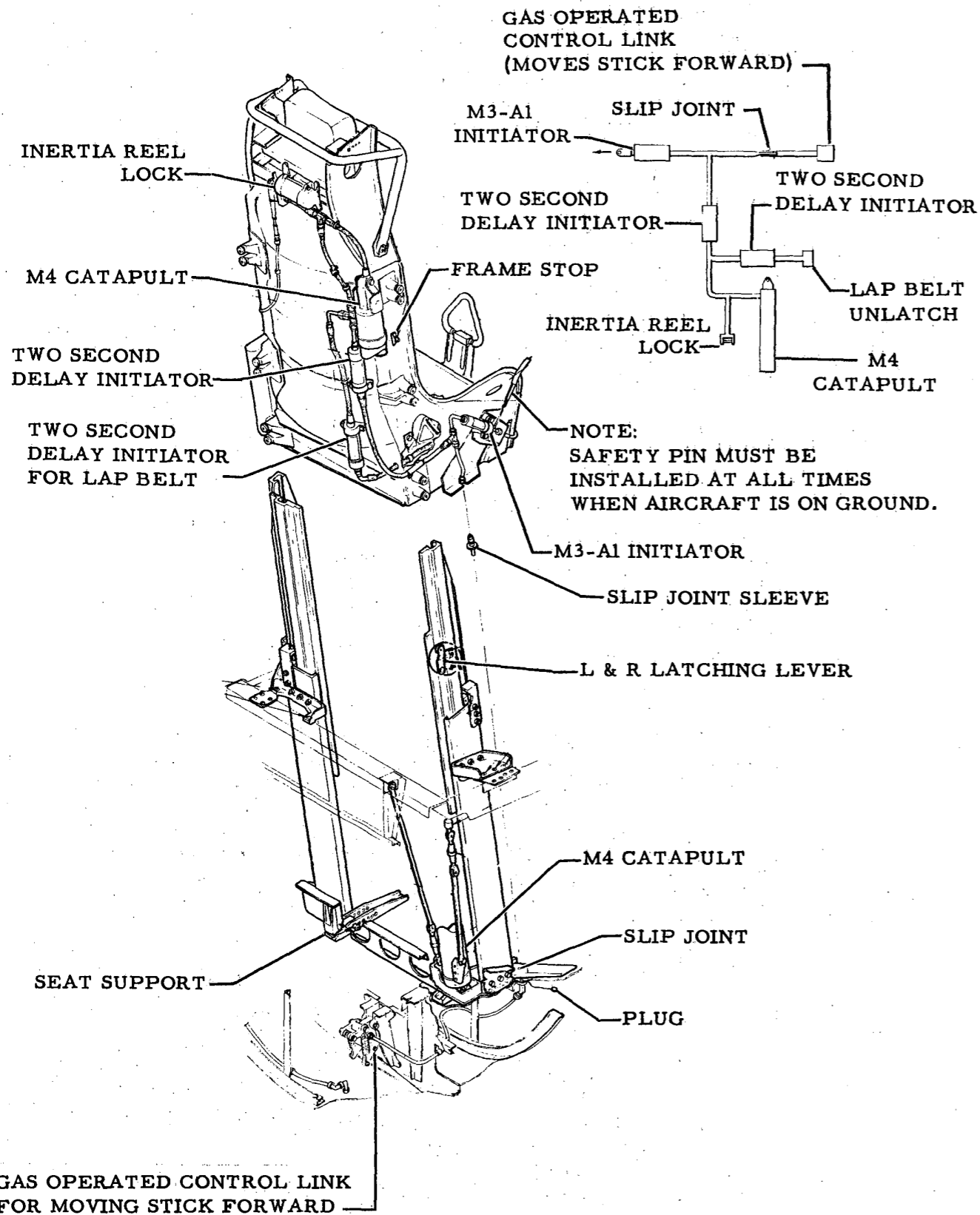

EJECTION SEAT
FIG. 1-16

~~SECRET~~

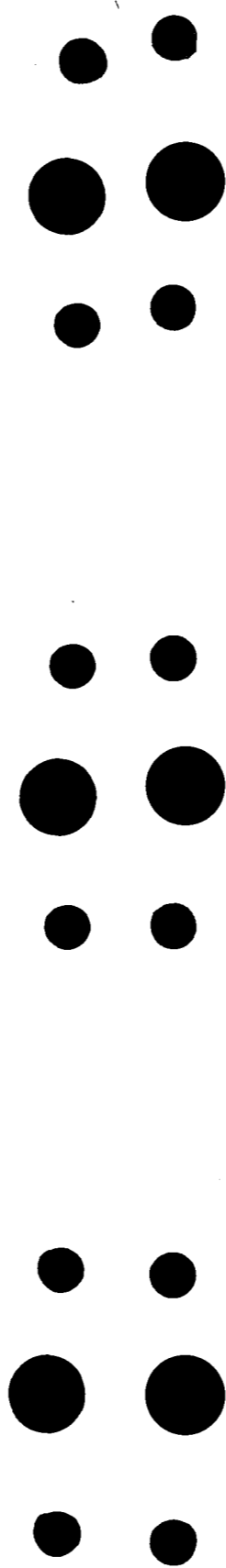

- Oxygen System
- Personal Equipment
- Communications and Associated Electronic Equipment
- Lighting Equipment
- Drift Sight System
- Sextant System
- Window Cover Jettison System
- Hatch Window Heater System
- Photographic Equipment
- Electronic Intelligence Systems
- F-2 Foil System
- AFSWP Nose System
- P-2 Platform System
- APQ-56 Radar Mapping Equipment
- Weather Survey Equipment
- Destructor
- Radar Doppler Automatic Navigation System (Radan)
- AN/ASN-6 Latitude and Longitude Computer
- MA-1 Compass System
- Autopilot System
- Miscellaneous

~~SECRET~~

2

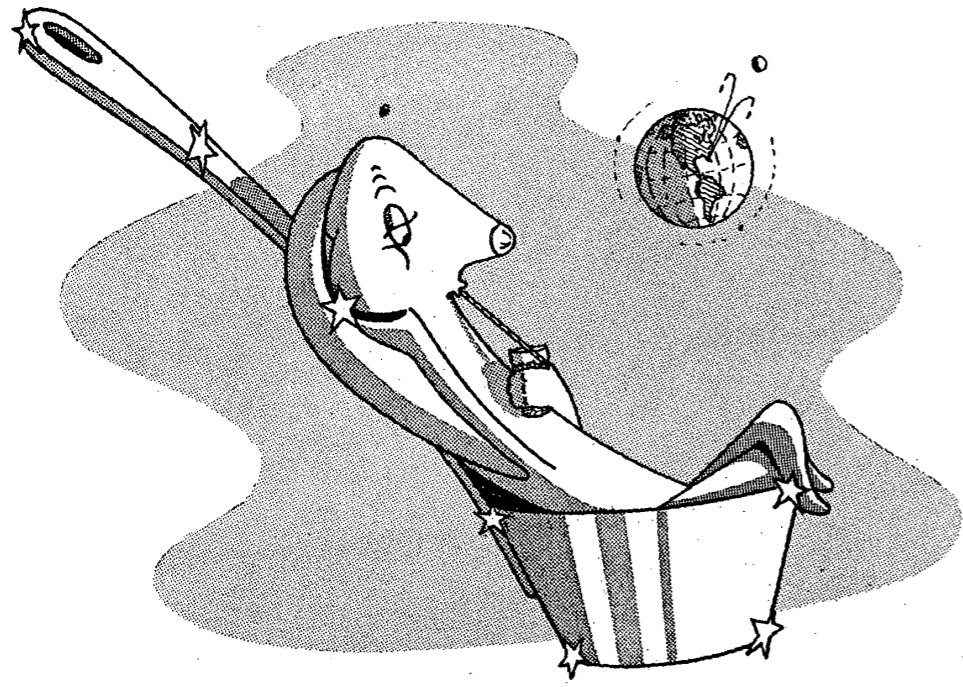

TABLE OF CONTENTS

	Page No.
STATUS OF THE AIRPLANE	2-2
BEFORE EXTERIOR INSPECTION	2-2
EXTERIOR INSPECTION	2-5
PRIOR TO BOARDING AIRCRAFT	2-8
PILOT EQUIPMENT CHECK	2-9
PILOT'S COCKPIT CHECK	2-11
START ENGINE	2-16
AFTER START	2-17
BEFORE TAXIING	2-18
TAXIING	2-18
BEFORE TAKE-OFF	2-19
TAKE-OFF	2-20
AFTER TAKE-OFF	2-23
CLIMB	2-25
CRUISE CLIMB	2-26
LEVEL OFF	2-30
DESCENT	2-31
5,000 FOOT CHECK (DESCENDING)	2-34
BEFORE LANDING	2-35
LANDING	2-38
AFTER LANDING	2-45
AFTER PARKING	2-45
CONDENSED CHECK LIST	2-46

SECTION



NORMAL PROCEDURES

~~SECRET~~~~SECRET~~STATUS OF THE AIRPLANE

FLIGHT RESTRICTIONS

Refer to SECTION V for all operating limitations.

FLIGHT PLAN

Accomplish the following:

1. The necessary fuel, airspeed and power settings required to complete a proposed mission should be determined by using the operating data from the Appendix. Proper charts should be prepared in order to keep a running check during flight of the fuel and oxygen remaining, distance covered and other important variables. Check performance data for required take-off distances. Information required to complete the Take-off Data Card is contained in Part 2 of the Appendix.
2. Ascertain which type of tactical equipment is installed for the mission and check any special operating instructions or techniques.
3. Check that the required communications channels and radio equipment will be available for the proposed mission.

WEIGHT AND BALANCE

Refer to Handbook of Weight and Balance, T.O. 1-1B-40 for weight and balance data. Also refer to SECTION V for additional information.

WARNING

Do not attempt take-off without a tactical load or ballast equivalent installed in the equipment bay. Verify that the aircraft loading falls within established limits.

ENTRANCE

Entrance to the airplane is gained from the right side of the fuselage. Use of an external ladder is necessary. The canopy can be unlocked from the outside of the aircraft by utilizing the exterior canopy locking handle.

BEFORE EXTERIOR INSPECTION

PILOT EQUIPMENT INSTALLATION

1. If the flight is to be made to altitudes in excess of 45,000 feet, a partial pressure suit must be worn. The airplane is equipped to accommodate a partial pressure suit and helmet. The pilot's oxygen and electrical

disconnect is of a special type and is matched to the seat pack provided. If the maximum flight altitude will not exceed 45,000 feet, a suitable flying suit may be worn instead of the partial pressure garment. When the partial pressure garment is not worn, the normal seat pack with suitable adapters will allow use of a P-4 flying helmet and A-13 oxygen mask as described in SECTION IV.

NOTE

Uncomfortable breathing oxygen pressures and garbled radio transmissions will be experienced with use of the A-13 oxygen mask unless a seat pack with special regulator settings is used.

2. The lower cavity of the seat is ordinarily filled with the special seat pack which is an integral part of the partial pressure suit. Some pilots find their comfort on long missions materially increased by placing wooden blocks underneath the front of the seat pack. This changes the angle of the seat pack to provide support to the upper leg.
3. Normally, the ejection seat is installed, however, it is possible that a non-ejection seat may be installed. A check should be made to ascertain which seat is installed in the aircraft since adjustment provisions on the two different installations are not the same. When the type seat installation is determined, check the following items:

a. Non-ejection seat.

Check to see that the fore-aft adjustment of the seat is satisfactory for the pilot flying the aircraft. There are also various thicknesses of seat pack cushions available. These should be tried and the most comfortable combination selected.

b. Ejection Seat.

The ejection seat does not afford a height adjustment to accommodate individual pilots; therefore, pre-cut plywood sheets or some suitable substitute should be placed under the seat pack to provide for correct seating height of the pilot flying the aircraft.

WARNING

The ejection seat height adjustment to accommodate individual pilots must be made with non-compressible material such as pre-cut plywood sheets. The chance of vertebral injury is increased considerably when the pilot sits on a thick, compressible mass, such as soft cushions placed on top of or under the seat pack. When such compressible items are used, the seat will not exert a direct force on the pilot until it has moved 2 or

~~SECRET~~~~SECRET~~

3 inches. After this amount of travel, the seat has gathered such momentum that excessive impact is produced when the seat initially lifts the pilot. The chance of injury is also increased during a crash landing.

4. Before the pilot completes oxygen pre-breathing, the seat pack should be installed in the airplane by a personal equipment specialist. Communications should then be checked through the seat pack.
5. A back type parachute must be worn whenever the seat pack is installed.
6. When flights are conducted in certain remote areas it is sometimes advisable to provide the pilot with additional survival equipment not contained in the seat pack. If this equipment is installed, check to ascertain that all required items are present in the aircraft and properly secured.

PREFLIGHT

The flight crews' preflight inspection is based on the assumption that maintenance personnel have completed the maintenance preflight contained in the Handbook of Inspection Requirements. Discrepancies noted during the flight crew's preflight will be recorded in DD Form 781 and the airplane cleared for flight by authorized maintenance personnel prior to take-off. Preliminary Cockpit Check and Exterior Inspections are normally performed by a qualified assistant prior to the pilot's arrival at the aircraft. This procedure is dictated by the limitations placed upon the pilot's movements in the partial pressure suit.

PRELIMINARY COCKPIT CHECK

1. Seat ejection system - Check (not applicable if non-ejection type seat installed.)
 - a. Seat ejection "D" ring secured in full down position by "D" ring retainer spring.

NOTE

If any discrepancy is noted during inspection of this system, do not enter the airplane until the system is checked by a maintenance technician.

- b. Seat ejection safety pin installed.
2. Form 781 - Checked for aircraft status.
3. Battery Switch - Off.

4. Auto pilot controller, sextant viewing scope and drift sight control panel - Proper installation and security of mounting. Viewfinder clear. Check proper control function.
5. Radio facility chart, appropriate letdown books - Present in aircraft and current.
6. Rubber sextant scope cover - In place.
7. Sun shade - Securely fastened.
8. Fan - Securely mounted.
9. Climb data card - Installed in aircraft.
10. Under seat and behind rudder pedals - Check for loose items.
11. Relief tube - Installed and secured.
12. Fuel totalizer - Check for proper setting.
13. Oxygen quantity - Check for 1800 PSI minimum.
14. Surge bleed valve, sump overflow and gust control lights for night operation - Lights taped.
15. Equipment bay upper hatch locking handles - Check for installation of bungee cord retainers. (Not applicable on airplanes with external latches only.)

EXTERIOR INSPECTION

A complete visual inspection of the aircraft is a very important part of each mission. The preflight starts before the pilot reaches the aircraft. Survey the proposed taxiing routes for any possible obstruction, such as fuel trucks, auxiliary power units and other maintenance support vehicles; also check for stray equipment or personnel that might be harmed by the jet blast.

When approaching the aircraft, note the general overall appearance and then begin the exterior inspection with the Main Landing Gear Area:

A. MAIN LANDING GEAR AREA

1. Tracker cover - Removed when applicable.
2. Tires - Examined for inflation and excessive wear.
3. Landing gear downlock pin - Installed.
4. Chocks - In place.
5. Hydraulic lines - Check for leaks.

~~SECRET~~

6. Shock strut - Check for 3/4" to 1 1/4" of chrome showing above red bottoming strip.
7. Circuit breakers - Check that C. B. 's located in wheel well are not popped or pulled. (Not applicable to all aircraft.)
8. Landing gear doors and locking levers - Good condition and secure.
9. Landing lights - Check for breakage and security of mounting.
10. Hydraulic reservoir door - Check securely closed.
11. Oil cooler scoop - Clear of obstructions.

B. FUEL TANK CAP CHECK - CAPS TIGHTENED.

C. RIGHT WING

1. Leading edge - Check for cracks, dents or other visible damage.
2. Pogos - Installed and locking pins in.
3. Lower wing surface - Check for wrinkles, fuel leakage or wet areas, lower surface of flaps and ailerons for condition.
4. Wing tip skid - Clear of aileron during aileron movement.
5. Aileron - Inspect for freedom of movement and general condition, and condition of fixed trim tab.
6. Flap - Down, drive shafts and piano hinge wire inspected.

D. RIGHT REAR FUSELAGE

1. Speed brake - Out, hydraulic actuator and hydraulic lines checked for security and hydraulic leaks.
2. Speed brake area of fuselage - Inspect for cracks, wrinkles, rolled rivet heads and oil seepage around rivet heads.
3. Anti-collision lights - Check for broken lenses.
4. Tail wheel - Inspected for down lock pin installation and steering scissors connected. Check tail wheel tires for condition.
5. Shock strut - Check for 1 1/2" to 2" of chrome showing above red bottoming strip.

E. EMPENNAGE

1. Leading edge of right horizontal stabilizer - Check for warping or visible damage.

2. Leading edge of vertical stabilizer - Check for warping, wrinkles, or visible damage.
3. Right elevator - Freedom of movement, security of hinges, security of trim tab, and general condition of elevator.
4. Drag chute doors - Check door lock in locked position.
5. Rudder - Visible damage, warping, freedom of movement.
6. Rudder trim tab - Check condition and for warping.
7. Tailpipe - Check condition of turbine and tailpipe.
8. Fuel vent - Check for obstructions.
9. Left elevator - General condition, security of hinges and security of trim tab.
10. Leading edge of left horizontal stabilizer - Check for warping and visible damage.

F. LEFT REAR FUSELAGE

1. Speed brake - Out, hydraulic actuator and hydraulic lines for security and hydraulic leaks.
2. Speed brake area of fuselage - Inspect for cracks, wrinkles, rolled rivet heads and oil seepage around rivets.

G. LEFT WING

1. Left wing flap - Down, drive shafts and piano hinge wire inspected.
2. Aileron - Inspect for freedom of movement and general condition. Check adjustable trim tab for condition and security.
3. Wing tip skid - Clear of aileron during aileron movement.
4. Pogo - Installed and locking pins in.
5. Lower wing surface - Check for wrinkles, fuel leakage or wet areas, lower surface of flaps and ailerons for condition.
6. Leading edge - Check for cracks, dents or other visible damage.

H. NOSE SECTION

1. Left engine air intake duct - Free from obstructions and foreign objects. Engine compressor blades free of dents and nicks.
2. Lower equipment bay hatch locking indicator (Left Side) - Locked.
3. Upper equipment bay hatch locking indicator (Left Side) - Locked.

~~SECRET~~

4. Free air temperature probe - Check for security.
5. Sextant dome cover - Removed.
6. Left static ports - Clear of obstructions.
7. Pitot head - Cover removed, pitot tube clear.
8. Drift sight dome - Cover removed, free of dirt.
9. Right static ports - Clear of obstructions.
10. Lower equipment bay hatch locking indicator (Right Side) - Locked.
11. Upper equipment bay hatch locking indicator (Right Side) - Locked.
12. Right engine intake duct - Free from obstructions and foreign objects. Engine compressor blades free of dents and nicks.

PRIOR TO BOARDING AIRCRAFT

*see Tech Data Change
FM-7*

When the pilot arrives at the aircraft, qualified personnel will be available to assist him in performing check lists up to engine start.

NOTE

In hot or extremely cold weather, every effort should be made to keep the pilot at a comfortably cool temperature prior to starting engines. If the pilot becomes too warm, he will perspire excessively; too cold a temperature results in pilot discomfort plus excessive face plate fogging.

1. Form 781 - Checked by pilot and Part 2 signed.
2. Seat pack quick disconnect and connections - Recheck properly connected to aircraft systems and safety clips attached.
3. Shoulder straps and safety belt - Fully extended to facilitate pilot hookup.
4. Parachute - Fitted to pilot.
5. Partial pressure suit capstan and breathing bladder hoses - Extended and free of parachute harness. (Applicable for high altitude flight only.)

see FM-7

B. PILOT EQUIPMENT CHECK - HIGH FLIGHT

1. Seat blocks and seat cushions - Installed as required.
2. Oxygen supply - Check aircraft oxygen supply 1700 to 1850 psi.
3. Oxygen supply - Check emergency oxygen supply to 1800 psi.
4. Quick disconnect - Check for safety pin installed on seat kit. Advise crew chief if missing.
5. Pilot enters aircraft - Connect to aircraft oxygen system. Primary system only - on.
6. Seat pack strap - Attach left seat pack strap to parachute and adjust.
7. Capstan hose - Connect to seat pack hose and install safety clip.
8. Bladder hose - Connect to seat pack hose and install safety clip.
9. Breathing hose - Connect to suit breathing connection and install clip.
10. Amphenol plug - Connected and locked.
11. Face heat - Attach emergency face heat cord to left side of face plate, circuit breaker pulled.
12. Seat pack strap - Attach right seat pack strap to parachute and adjust.
13. Green apple cable - Position under right lap belt and secure with strap and snap.
14. Harness - Connect shoulder harness to lap belt.
15. F-1 release - Attach to lap belt and lock belt.
16. Low altitude escape lanyard - Hooked to parachute "D" ring.
17. Radio bypass cord - Under left lap belt.
18. Face plate - Recheck locked and secure.
19. Press-to-test - Check for oxygen leaks and for suit inflation in 9 seconds.
20. Auxiliary power - Connected and on.
21. Secondary oxygen valve - On.

see FM-7

B. PILOT EQUIPMENT CHECK - HIGH FLIGHT

1. Seat blocks and seat cushions - Installed as required.
2. Oxygen supply - Check aircraft oxygen supply 1700 to 1850 psi.
3. Oxygen supply - Check emergency oxygen supply to 1800 psi.
4. Quick disconnect - Check for safety pin installed on seat kit. Advise crew chief if missing.
5. Pilot enters aircraft - Connect to aircraft oxygen system. Primary system only - on.
6. Seat pack strap - Attach left seat pack strap to parachute and adjust.
7. Capstan hose - Connect to seat pack hose and install safety clip.
8. Bladder hose - Connect to seat pack hose and install safety clip.
9. Breathing hose - Connect to suit breathing connection and install clip.
10. Amphenol plug - Connected and locked.
11. Face heat - Attach emergency face heat cord to left side of face plate, circuit breaker pulled.
12. Seat pack strap - Attach right seat pack strap to parachute and adjust.
13. Green apple cable - Position under right lap belt and secure with strap and snap.
14. Harness - Connect shoulder harness to lap belt.
15. F-1 release - Attach to lap belt and lock belt.
16. Low altitude escape lanyard - Hooked to parachute "D" ring.
17. Radio bypass cord - Under left lap belt.
18. Face plate - Recheck locked and secure.
19. Press-to-test - Check for oxygen leaks and for suit inflation in 9 seconds.
20. Auxiliary power - Connected and on.
21. Secondary oxygen valve - On.

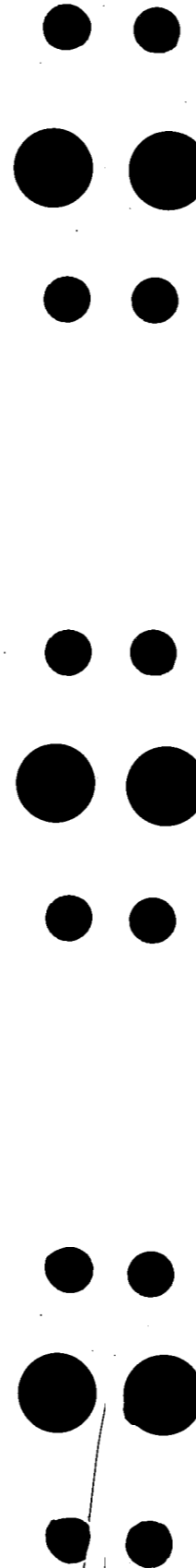
*see FM-7*

22. Primary oxygen valve - Off. Check that "PRIM OFF" oxygen warning light is illuminated. Check that low pressure oxygen gage reads approximately 70 psi.
23. Secondary oxygen valve - Turn off momentarily and check that the "LOW PRESS" oxygen warning light is illuminated. Turn valve back on to restore oxygen flow to the pilot.
24. Primary oxygen valve - On. With both valves on, check that both oxygen warning lights are out and that the low pressure oxygen gage reads approximately 80 psi.
25. Face heat - Check for face plate heat and advise pilot to check radio.
26. Oxygen - Recheck aircraft and emergency supply.

PILOT'S COCKPIT CHECK

It is important that the cockpit check be carefully completed in sequence with no items left until later. Once the engine is started, the airplane is ready for take-off and close attention is required to flying the aircraft during the early climb. The cockpit check will be jointly accomplished by the pilot and assistant utilizing the challenge and response system. All checks subsequent to the cockpit check will be performed by the pilot and monitored by the mobile control officer. The pilot's response or action is shown in capital letters.

1. Inverter - ON, LIGHT OUT.
2. MA-1 Compass - SLAVED.

Slave-free switch in "Slaved" position. Set heading on compass indicator by moving "SYNC" knob in desired direction to have comparable headings on Magnetic Compass and slave compass indicator. Observe Sync needle to be on scale.

3. Radio compass - ANTENNA.

NOTE

Assistant connects headset to radio bypass wire and turns recorder switch ON.

4. Flight plan - FILED.
5. Anti-collision light switch - ON.
6. Fan - CHECKED AND OFF.

Check high and low speed operation.

7. Seal valves - ON.
8. Landing lights - CHECKED AND OFF.
9. Emergency fuel shutoff - COVER DOWN.
10. Gust control - FAIRED.
11. Wing flap switch - UP.
12. Friction lock - ADJUSTED.
13. Throttle - OFF.
14. Speed brake switch - FORWARD.
15. Left canopy jettison handle - ALIGNED AND SAFETIED.

Check handle full forward. Check seal dump lever safetied and red marks aligned.
16. Oxygen pressure - CHECKED.

Normal operating range for take-off - 1700 to 1850 PSI.
17. Gear handle - DOWN, WARNING SYSTEM CHECKED.

Check indicators for down and locked position. Check gear handle warning light and horn for operation.
18. Fuel transfer switch - OFF.
19. Drag chute handle - IN.
20. Ram air switch - OFF.
21. Face heat - SET.

Rheostat control is normally set from 9-12 o'clock.
22. Cabin heat selector - AUTO.
23. Cabin temperature - SET.

Rheostat control is normally set from 10-12 o'clock for take-off.
24. Generator-battery switch - OFF.
25. Pitot heat - OFF.
26. AC Alternator switch - ON.
27. Master watch - INSTALLED.

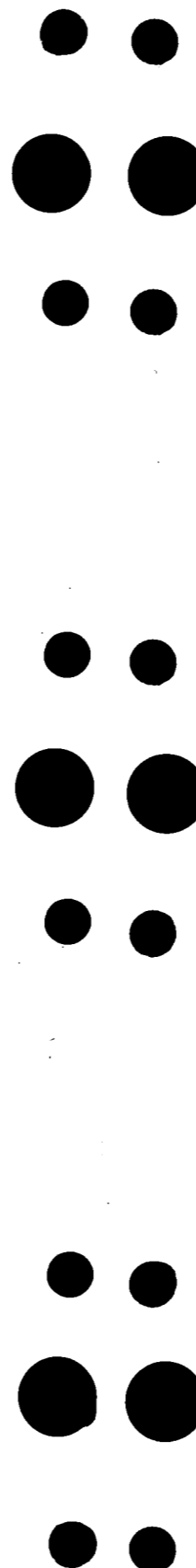

- Install for celestial missions.
28. Aircraft clock - SET.

Set with tower time or Master Watch if available.
 29. Emergency face plate heat circuit breaker - PULLED.
 30. All other circuit breakers - SET.

In with white or yellow band showing.
 31. Fuel totalizer - SET.

Set for proper fuel load. Totalizer drum can be rotated in either direction if DC power is off or if the fuel counter circuit breaker is pulled.
 32. Sump overflow light - ILLUMINATED.

This light will glow when the sump fuel tank has been serviced and the engine has not used the first 8 gallons of fuel.
 33. Instrument and panel lights - SET.

Rheostats should be turned OFF for VFR day flights. For night or instrument operation, set as desired.
 34. Emergency fuel control switch - NORMAL.
 35. Destructor - SAFETIED.
 36. Push-to-test lights - CHECKED.

Check all push-to-test lights by pushing in on covers. Start on left side of cockpit and work across to the right.
 37. Auto pilot - CHECKED AND OFF.
 - a. Engage auto pilot. There should be no fore and aft movement of control column. The wheel should return to near center position in roll axis.
 - b. Actuate roll trim knob to full travel in both directions. Wheel should travel smoothly an equal distance each side of neutral. Return roll trim knob to the position that centers wheel and set white roll trim knob position indicator to indicate neutral.
 - c. Actuate pitch trim knob in both fore and aft directions and observe that control column follows trim control in both directions. Movement should be smooth.
 - d. Actuate turn command knob to full travel in both directions. Wheel should smoothly follow command knob an equal distance

in both directions. When turn command knob is dropped into the detent position, the wheel should return to near neutral position. (NOTE: Wheel will sometimes stop slightly short of the neutral position. This condition is normal during ground checking of the auto pilot.)

- e. Actuate yaw trim knob to full travel in both directions. Rudder pedals should smoothly follow the trim knob in the proper direction and should displace equal distance from neutral when the rudder trim knob is turned to full displacement in either direction. Return rudder trim knob to proper position to neutralize rudder position.
- f. Engage mach sensor control by pressing mach sensor indicator light. No substantial control column movement should occur when mach sensor is engaged.
- g. Over-power auto pilot in all axes with mach sensor "ON". Controls should return smoothly to normal.
- h. Disengage mach sensor by depressing OFF button.
- i. Turn auto pilot OFF by depressing auto pilot disconnect button on the inside of the control wheel right handgrip.
- j. Manually hold the control column full forward for approximately 5 seconds and then re-engage the auto pilot. Engagement should be smooth indicating auto pilot synchronization.
- k. Disengage the auto pilot again.
- l. Hold the control column full to the rear for approximately 5 seconds and then re-engage the auto pilot. Engagement should be smooth.
- m. Turn the auto pilot OFF.

- 38. Equipment master switch - OFF.
- 39. Equipment mode selector - OFF.
- 40. Defroster - OFF.

The handle may be set in any desired position with a P-31 engine. However, with the P-37 engine, since this type engine throws oil on the windshield, the defroster should not normally be used until needed.

- 41. Cover jettison switch - COVER DOWN.
- 42. Hatch heater switch - OFF.
- 43. Altimeter selector switch - EQUIPMENT BAY.

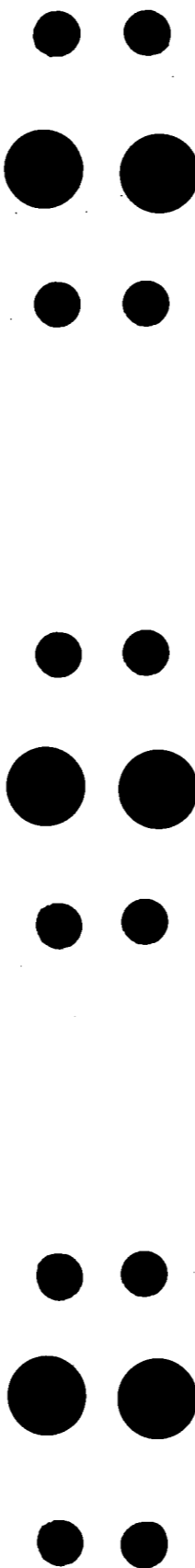

- 44. Trim power switch - ON.
- 45. Trim tabs - CHECKED AND NEUTRAL.

The assistant will move the trim switches as required to align the aileron and elevator trim tabs to neutral by following the crew chief's signals. Tabs will be checked for proper direction of movement.

- 46. Rudder pedals - ADJUSTED.
Adjust rudder pedals while crew chief holds rudder neutral.
- 47. Cockpit auxiliary lights - SET.
Rheostats should be OFF for VFR day flights. For night or instrument flights, set as desired.
- 48. Flashlight - CHECKED.
- 49. Mission special equipment - SET.

Pre-set as briefed or as required from appropriate equipment check list.

- 50. Oxygen quick disconnect - CHECKED.
Locked with locking pin pointing towards pilot on non-ejection seat. Lock pin installed on ejection seat.
- 51. Suit connections - CHECKED.
Re-check the "T" fittings and seat pack connections. Insure all connections are safetied.

- 52. Low altitude escape lanyard - HOOKED.
- 53. Face plate latch - LOCKED.
- 54. Emergency face heat cord - CONNECTED.
- 55. Green apple - SECURE.

Check emergency oxygen supply cable secured under seat belt and suit snap retainer with green apple plainly visible.

- 56. Assistant disconnects headset and turns recorder switch OFF.
- 57. Radio bypass cord - STOWED.
- 58. Radio compass - CHECKED.

Check antenna, loop and compass positions.

59. Canopy - CLOSED AND LOCKED.
60. Yaw string - FREE.
61. Ladder - REMOVED.

START ENGINE

The start engine and after start check lists will be performed by the pilot without the use of an assistant. The canopy will be closed and locked prior to engine start because of the possibility of engine damage if loose items should be drawn into the air intake.

1. Brakes - HOLD.

Hold the brakes until ready to taxi.

2. Starting unit - SIGNAL START.

Give the wind-up signal (circular motion of index finger) to start auxiliary starting unit.

3. Starting air - SIGNAL ON.

After starting unit reaches full RPM, raise hand with thumb up to signal crew chief that you are ready for starting air.

4. Throttle - IDLE.

Place throttle in idle when engine RPM reaches 12-16%.

5. Ignition Switch - START AND HOLD.

Immediately after placing throttle in idle, place the ignition switch to start and hold it.

CAUTION

If a normal start is not indicated by a rise in EGT and/or oil pressure within 30 seconds after the throttle is placed in idle, release ignition switch, return throttle to OFF, and signal starting air OFF. Allow excess fuel to drain from engine prior to attempting next start.

If excessively high EGT is encountered during start, release ignition switch, return throttle to OFF and allow starting air source to rotate engine until EGT returns within limits.

6. Ignition switch - RELEASE.

Release the ignition switch when engine starts.

7. APU and starter air - SIGNAL DISCONNECT

At 40% RPM, signal with thumb out to disconnect APU and starter air.

NOTE

It is not abnormal for the engine to chug several times while accelerating to idle RPM.

8. Generator-Battery switch - GEN-BAT.

Place in GEN-BAT position after the auxiliary electrical power is disconnected.

AFTER START

1. Idle RPM - CHECKED.

Check idle RPM at 55% \pm 2% for the P-31 engine and at 57% \pm 2% for the P-37 engine.

2. Engine instruments - CHECKED .

Check all engine instruments and hydraulic pressure gage indicating within normal operating range.

3. Flight instruments - CHECKED.

a. Altimeter set to current station altimeter setting and indicating within 75 feet of station altitude.

b. Vertical speed indicator indicating zero.

c. Airspeed indicator indicating approximately 30 knots.

d. MA-1 compass indication corresponds approximately with the magnetic compass. MA-1 synchronization needle centered.

e. Turn and slip indicator centered.

f. Attitude indicator erected and miniature aircraft set level with 90 degree indices on the sides of the case.

4. Wing flaps - UP.

Check wing flap position indicator to read zero.

5. Flight controls - CHECKED.

Check ailerons and elevators for freedom of movement and full range of travel. Rudder movement and range of travel will be restricted with airplane stationary due to tail wheel steering.

6. Fan - ON.

Normally, the HI position will be used.

7. Generator-Battery - CHECKED.

- a. Select BAT. position and check battery for electrical output by noting proper operation of inverter and AC instruments.
- b. Select GEN-BAT position and check loadmeter for normal indication of generator electrical output. (.1 to .4)

BEFORE TAXIING

This check will be performed by a qualified assistant.

1. Anti-collision lights - Checked.
2. Camera window covers - Checked.
Removed, unless they are to be jettisoned in flight.
3. Engine access doors - Closed.
4. Landing gear pins - Removed.
5. Wheel chocks - Removed.
6. Route of taxi - Check clear and signal pilot clearance for taxi.

TAXIING

The aircraft can be taxied normally if sufficient space is available. The minimum turning radius with pogos installed is approximately 300 feet in zero wind. Winds up to 30 knots from any direction can be compensated for with slight increase in turning radius. Because of the large turning radius and large wing span, care must be exercised to insure that turns are started with sufficient space available.

If the situation requires, the aircraft will be lined up for take-off by the ground crew.

Ground and taxi time should be held to a minimum to reduce the amount of fuel used before flight.

CAUTION

Taxiing at light weights over uneven surfaces or at too fast a speed will cause the pogos to fall out of their sockets if the safety pin has been removed. With heavy weights, taxi at reduced speed and exercise caution to avoid possible rough areas.

BEFORE TAKE-OFF

Special effort should be made to assure that a comprehensive pre-takeoff check is performed. Due to the fast acceleration, short takeoff roll, and steep climb angle, insufficient time is available after takeoff to accomplish checks which might have been neglected prior to beginning the takeoff run.

1. Radio call - COMPLETED.

Obtain control tower clearance and then taxi the aircraft into position on the active runway. Aircraft will be brought to a stop in the center of the runway.

2. Shoulder harness - LOCKED.

Move locking handle forward to lock shoulder harness.

3. Canopy - CLOSED AND LOCKED.

Recheck canopy closed, locked and with seal valves ON.

4. Equipment master switch - ON. (If applicable)

5. Hatch heater switch - ON. (If applicable)

This applies only to aircraft having a P-31 engine installed on missions utilizing camera configurations.

6. Pitot heat switch - AS REQUIRED.

7. Seat ejection safety pin - REMOVED.

Remove pin and hold up for visual check.

8. Pogo locking pins - REMOVED.

Crew chief will remove pins and display to pilot.

9. Takeoff clearance - OBTAINED.

10. Engine instruments - CHECKED.

Recheck all engine and flight instruments for proper indications.

Advance throttle until surge bleed valve light goes out (85% RPM maximum).

11. Sump overflow light - OUT.

12. Brakes - RELEASED.

After instruments are checked, release brakes and advance engine RPM to desired takeoff power.

TAKE-OFF

GENERAL

The airplane has a high thrust to weight ratio. This factor together with a low wing loading causes the acceleration to be rapid and the take-off runs to be very short. If desired, take-off may be made using less than maximum engine power.

NOTE

Line speed and refusal speed computation and utilization is not normally feasible with this aircraft due to the rapid acceleration, extremely short take-off run and preoccupation of the pilot with directional control. However, the tactical situation might require the use of take-off data for very short runways.

NORMAL TAKE-OFF

Fuel Load Greater Than 800 Gallons

1. The throttle can be advanced slowly through 70% RPM to avoid engine "chugging", if desired. However, throttle bursts can be made since chugging does no damage and does not slow acceleration time. At approximately 85% RPM release the brakes and advance power to take-off RPM: Approximately 94% for the P-37 engine, approximately 96% for the P-31 engine.

CAUTION

The brakes must not be used to hold more than 85% RPM or landing gear failure may result.

2. The control column should be held full forward during the initial take-off roll, maintaining directional control with tail wheel steering until the tail wheel starts to rise from the runway. At

approximately 50 knots the wings will start to rise and allow the pogos to fall off. At this time use care to keep the wings level, especially in cross winds. If one wing is allowed to rise prematurely, directional control difficulties will be aggravated. Usually, in this case, the pogo will fall out before there is sufficient aileron control to hold the wing up. Mobile control or other ground personnel will inform the pilot when pogos are clear of the aircraft. This procedure will enable the pilot to better concentrate on the remainder of the take-off.

3. At approximately 70 knots the tail will start rising, requiring the control column to be brought back slightly to hold tail wheel approximately one foot above the ground. This attitude is easily maintained at full throttle and these heavier fuel loads.

CAUTION

It is possible to develop a porpoise on take-off. The usual cause is the airplane becoming airborne without the pilot realizing it and the control column being pushed forward or rapid movements being made with the control column just prior to leaving the ground. If a porpoise should develop on take-off, bring the control column back easily to keep the airplane in the air. Trying to fight the porpoise by pumping the column back and forth will only aggravate the condition.

The acceleration will be fast and the aircraft will reach take-off speed rapidly, where moderate back pressure is applied to become airborne. The recommended take-off speeds allow a 15% margin over the stall speed and are as follows:

<u>FUEL (Gal)</u>	<u>TAKE-OFF SPEED (Knots)</u>
800 - 1100	95 - 100
1100 - 1335	100 - 105
1335 - 1535	105 - 110

CAUTION

Use caution in order to avoid a stall immediately after take-off. Do not assume the very steep climb angle to which you may be accustomed from flying at light weights, since an accelerated stall may be encountered under these conditions.

Fuel Load Less Than 800 Gallons

Procedures employed for take-off with fuel loading less than 800 gallons is identical to the heavier gross weight take-off except as noted.

1. After releasing brakes on take-off roll, a normal take-off may be accomplished with the throttle set for any engine RPM between 85% and full engine power.

NOTE

With light fuel loads, lining up on the crown of the runway may result in one pogo falling out prior to start of the take-off run. In this event, take-off can be made with one pogo by holding that wing down until ample aileron control is assured.

2. At high engine power settings, considerable care should be exercised to maintain proper take-off attitude after the tail wheel has lifted from the runway. Control column back pressure will have to be commenced prior to reaching take-off speed to prevent the aircraft assuming an excessively tail high attitude. If an excessively tail high attitude is allowed to develop, difficulty will be encountered in completing a normal take-off without allowing the forward landing gear to again contact the runway after initially breaking ground. Approximate take-off speed for these lighter weights is 90-95 knots.

CAUTION

Recovery from porpoising encountered on take-off with less than 800 gallons of fuel is identical to the heavy gross weight condition, except that full engine power should be added if not already used, in order to aid in prompt recovery from the porpoising condition.

CROSS WIND TAKE-OFF

In addition to the procedures given for normal take-off, the following steps are included for cross-wind take-offs:

1. Raise the tail slightly higher than for normal take-off to preclude the possibility of becoming airborne before full control is gained. With a 20 knot cross-wind component, full rudder will be required to maintain a straight line prior to leaving the ground.
2. Hold the up-wind wing down.

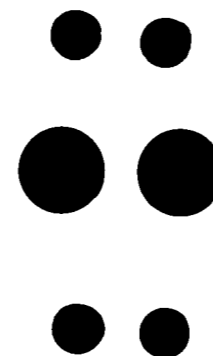
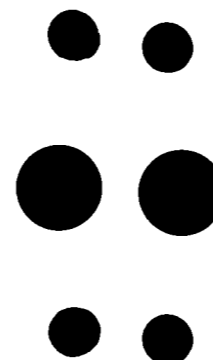
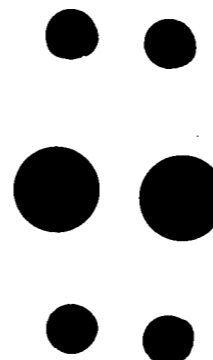

3. Counteract drift when aircraft becomes airborne by skidding with rudder and holding wing low into wind. This will enable you to hold heading in case gusty air causes unintentional contact with runway.

NOTE

Only a slight bank is required to compensate for the yaw, so there is no danger of a wing tip striking the ground while correcting for drift with rudder.

NIGHT TAKE-OFF

Night take-off procedures are the same as those employed for daylight take-off.

MINIMUM RUN TAKE-OFF

Since the airplane has excellent take-off performance using normal procedures, the need for a special minimum run take-off is minor. However, the take-off run can be shortened by use of the following techniques:

1. The gross weight of the aircraft should be decreased as much as possible by reducing the fuel load to the bare minimum required for the flight.
2. Leave wing flaps UP. (Faired position)
3. Advance the throttle to 85% prior to releasing the brakes.
4. Release brakes and throttle burst engine to maximum power.
5. The control column should be held slightly aft of neutral at the start of the take-off run.
6. Fly the aircraft off the runway in a two point attitude using care not to stall after becoming airborne.

AFTER TAKE-OFF

CLIMB SPEED

The airplane accelerates rapidly and close attention is required after take-off to hold the speed to the proper climb speed of 160 knots IAS, which is correct up to 50,000 feet.

WARNING

With full power, the aircraft will quickly accelerate past the gust control FAIRED placard speed of 220 knots if attention is diverted after take-off. The airspeed limitations must be observed or structural failure may result. The speed warning system, if installed, will sound the warning horn and automatically extend the speed brakes at approximately 220 knots IAS.

LATERAL TRIM

After stabilizing at climb speed for a few minutes, the adjustable aileron trim tab should be used to relieve any wing heavy condition. This should always be done with full fuel loads. With partial fuel loads, if it is suspected that the fuel load may not be evenly balanced, the adjustable tab should not be used. In this event, the fuel cross-transfer system should be used to alleviate the wing heaviness.

Once the aircraft is in trim, note the wheel position. During the remainder of the flight and especially before landing, use the fuel cross-transfer, if necessary, to return the wheel to this position.

TURBULENT AIR

If turbulence is encountered, or anticipated, the gust control should be actuated to the GUST position and normal climb speed maintained. Otherwise, the gust control should be left in FAIRED position for the climb. Upon reaching smooth air conditions, the gust control should be returned to the FAIRED position.

CAUTION

1. In shifting from FAIRED to GUST, an abrupt nose-up trim change occurs. This may be compensated with moderate elevator force until the elevator trim tab action catches up. In shifting from GUST to FAIRED, a nose-down trim change occurs.
2. Actuation of the gust control from GUST to FAIRED should be done at an indicated air-speed of 160 knots or less.

Always monitor the wing flap position indicator when shifting from GUST to FAIRED. If flaps do not stop at FAIRED, return the switch to the GUST position.

CLIMB

ENGINE OPERATION

Maximum engine power is normally used for all VFR climbs. See SECTION IX for information on engine operation during adverse weather conditions.

The throttle can usually remain in the full forward position up to approximately 50,000 feet, after which minor adjustments will be necessary to keep exhaust gas temperature, engine pressure ratio and RPM within prescribed limits. See SECTION V for engine operating limitations.

AIRCRAFT ATTITUDE

The aircraft climb attitude with maximum power is very steep up to 20,000 to 25,000 feet. Close attention is required to hold the proper climb speed of 160 knots from ground level to 50,000 feet. Above this altitude, the climb speed gradually decreases to 100 knots at 74,000 feet.

CLIMB CHECK

NOTE

Items 4 and 5 will be completed after passing 5,000 feet.

1. Landing lights - OFF.
2. Landing gear - UP, INDICATORS CHECKED.
3. Climb speed - 160 K
4. Low altitude escape lanyard - UNHOOK AND STOW.

(Applicable only to aircraft with ejection seats.)

WARNING

This check is of utmost importance on high altitude missions since ejection at high altitude with the lanyard connected would result in excessive parachute opening shock and prolonged exposure.

5. Engine and flight instruments - CHECKED.

Check all engine and flight instruments for proper indication.

6. Aileron wheel position - NOTE.

7. Defroster - ON (P-31 engine)

8. Autopilot - ENGAGED.

At pilot's discretion, engage the autopilot. Check the autopilot trim and flight operation during climb between 40,000 and 45,000 feet.

9. Gust control - FAIRED.

If initial climb was made in gust, turn autopilot off prior to switching gust control to FAIRED. Re-engage autopilot.

10. Pressurization - CHECKED.

Check cockpit and equipment bay pressure for positive pressurization within limits at 40,000 feet (Approximately 20,000 feet).

11. Oxygen quantity - CHECKED.

12. Oxygen system - PRESS TO TEST.

Check suit connections and oxygen pressure regulator by use of "Press-to-Test" between 40,000 and 45,000 feet.

13. Altimeter - SET AT 29.92 ABOVE 45,000 FEET.

14. Equipment mode selector - STANDBY.

15. Special equipment - ON, AS BRIEFED.

CRUISE CLIMB

GENERAL

Upon reaching 64,000 to 66,000 feet, depending on fuel load and atmospheric conditions, the climb performance will decrease to a point where it becomes a cruise climb. The cruise climb comprises the major portion of the total flight time and is flown in a manner to obtain maximum range.

AIRCRAFT CONTROL

Normally, the autopilot with mach sensor is used to control the aircraft throughout the cruise climb. The desired cruise climb airspeed schedule is not quite a constant mach number; therefore, the mach sensor will not control the air-

speed exactly. The airspeed indicator must be frequently checked. If necessary, the mach sensor must be disengaged and re-engaged at the proper indicated airspeed. In case of autopilot malfunction, the cruise can be continued without the autopilot by manually flying the aircraft at the proper airspeed. This is no more difficult than instrument flight. The climb speed schedule is as follows:

<u>ALT.</u>	<u>SPEED (Knots)</u>
50	160
55	150
60	135
62	130
64	124
66	118
68	112
70	108
72	104

*see FM-4
TDC*

ENGINE OPERATION

The engine is operated at maximum permissible power throughout the cruise climb. The primary instrument used for power setting is the exhaust gas temperature gage. Engine speed and pressure ratio are available for cross checking. See SECTION V for engine operating limitations.

Abrupt throttle movements should be avoided at high altitude due to the possibility of causing flameout. Also, aircraft yaw or abrupt pitch maneuvers can cause engine flameout due to disturbances to airflow in the intake ducts. These maneuvers should be avoided, particularly with the P-37 engine.

ALTITUDE CONTROL

With the P-37 engine an altitude will eventually be reached during the cruise climb where the engine is operating at idle RPM, the exhaust gas temperature is up to the maximum, and the aircraft is still climbing. When this condition occurs, prompt action must be taken to prevent over temperature operation of the engine. Initially, the condition may be corrected merely by allowing the aircraft speed to increase while maintaining constant altitude. When the speed has increased to a point within 5 knots of the needle, aerodynamic drag should be added. The initial drag is created by using the variable speed brake or extending the landing gear. As the aircraft descends, engine power is increased to maintain engine operation at maximum limitations. Eventually, the aircraft will cease descent and again begin a cruise climb. When the aircraft again reaches the altitude of limiting conditions, the remaining drag devices will be used.

The P-31 engine will normally never reach an altitude where idle RPM is encountered. However, maximum altitude is limited to the point where maximum exhaust gas temperature is reached and power cannot be further reduced without dropping below the minimum engine pressure ratio limit. The corrective procedure is the same as outlined above for the P-37 engine.

AIRSPEED CONTROL

The airspeed schedule must be followed closely to obtain maximum range and altitude. One knot indicated airspeed at 70,000 feet is equivalent to four knots true airspeed. At this altitude the climb schedule is approximately 10 knots IAS below the mach limit of the aircraft. Close attention must be given to pitch and attitude control. If the airspeed becomes too fast, slight tucking tendencies will result and subsequent loss of altitude will occur. Recovery is easily effected by overpowering the tucking tendency and regaining proper air-speed.

The engine is sensitive to airspeed at high altitude. Low speed may induce compressor stall and consequent flameout. With the P-37 engine, if the air-speed drops as much as 10 knots below the proper schedule, a flameout is probable. The P-31 engine has much greater tolerance to low airspeed.

AIRCRAFT TRIM

The autopilot incorporates an automatic pitch trim feature which eliminates the need for manual pitch trim corrections when using the autopilot. If the aircraft becomes out of trim laterally, it is probably caused by uneven fuel feeding from the wing tanks. This situation should always be corrected by use of the fuel cross transfer system. With the autopilot engaged, wheel position or the roll trim indicator may be observed to determine when enough fuel has been transferred. Neither the autopilot roll trim knob nor aileron trim tab should be used to compensate for uneven wing tank fuel feeding. See SECTION IV for a complete explanation of procedures to be followed to insure that the autopilot is properly trimmed for flight.

NOTE

If an uneven fuel feeding condition is allowed to persist, the autopilot clutch will eventually slip and manual assistance will be required to maintain a wings level attitude until the condition is corrected by use of the fuel transfer switch. Normally, a wing heavy condition with the autopilot engaged will be noted by the indication of the autopilot roll trim indicator and the gradual rotation of the wheel from the neutral position.

CRUISE CHARTS

During the course of long missions, which may last many hours, it is advisable to keep a running check of fuel and oxygen consumption. This is necessary in order to disclose excessive consumption as early as possible so that corrective action may be taken. The simplest method is by use of a graph which shows the anticipated usage as a function of time. These graphs are shown in Figure 2-1. During the mission, periodically read and plot the oxygen pressure and fuel totalizer reading.

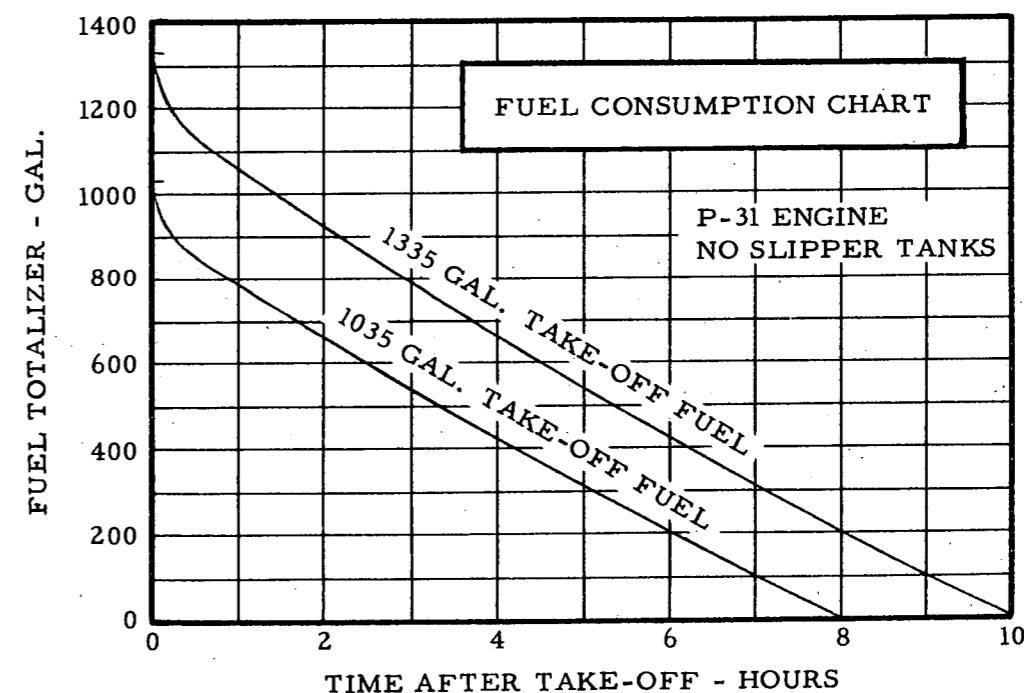
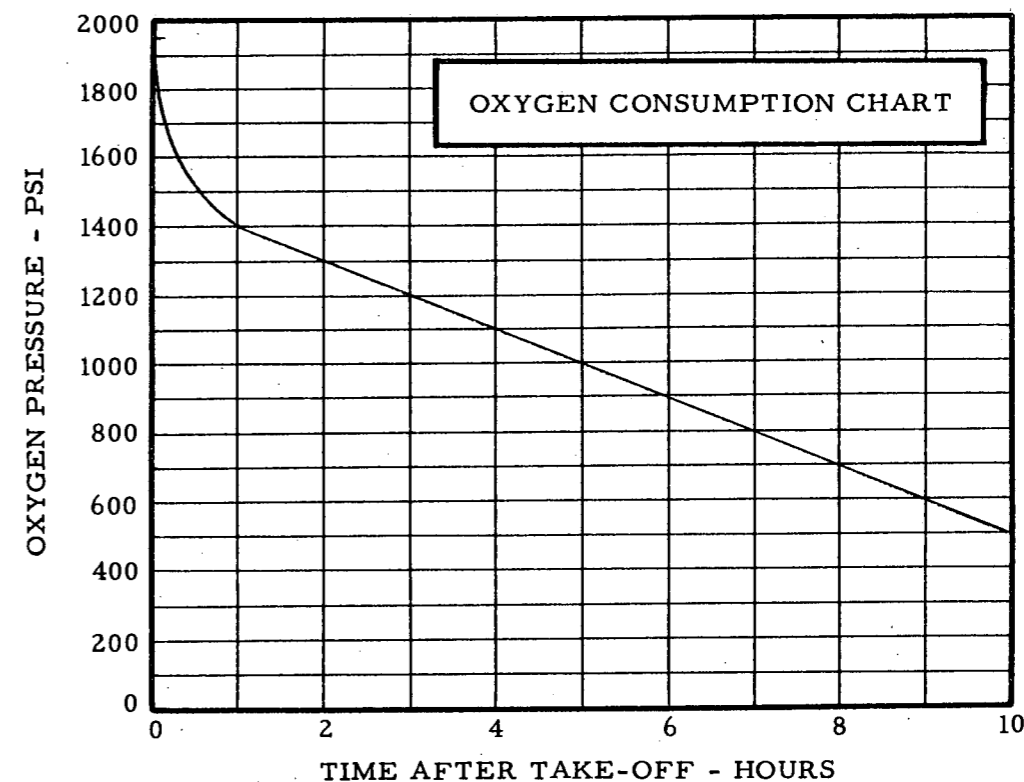

Figure 2-1

PILOT COMFORT

During the long cruise climb portion of a normal mission pilot comfort assumes considerable importance. Pilot comfort can be substantially increased if a proper balance is achieved between cabin temperature and face plate heat. Best results are obtained utilizing the following procedures:

1. Keep face plate heat as low as possible without inducing fogging.
2. Keep the defroster fan running continuously to circulate cockpit air.
3. Use the engine air defroster only as necessary to eliminate windshield and canopy frosting.

NOTE

A late modification provides cooler air for defrosting. Under some conditions the fan may be left off if desired and defrosting maintained by increased defroster air flow.

4. Keep the cabin temperature control at the warmest setting consistent with pilot comfort to aid in keeping the feet warm and eliminating windshield and canopy frosting.

As an aid to pilot comfort and also as a check on the oxygen system, it is recommended that the seat pack "Press-to-Test" be actuated approximately every one half hour.

SYSTEMS OPERATION

Refer to SECTION VII for information regarding systems operations.

FLIGHT CHARACTERISTICS

Refer to SECTION VI for information regarding flight characteristics.

LEVEL OFF

Special mission considerations may dictate continued operation at an altitude below maximum cruise altitude. Level flight at a pre-selected altitude may be achieved as outlined below.

LOWER ALTITUDES

At altitudes below 50,000 feet, reduce engine power to the amount required to

maintain level flight at the required airspeed.

For ferry flights, cruise can be accomplished at 45,000 feet if desired. This gives several advantages: No pressure suit or pre-breathing required; the zero wind range is still appreciable if proper powers and speeds are used; possible tail winds are available; approximately the same true speed as on a regular cruise climb can be maintained.

HIGHER ALTITUDES

At altitudes above 50,000 feet reduce engine power to maintain proper airspeed until minimum pressure ratio values are reached.

If constant airspeed is not necessary, allow the airspeed to increase as fuel is consumed. When the airspeed is within 5 knots of the needle or if airspeed must be held constant, utilize the variable speed brakes to add aerodynamic drag. In extreme cases extend the landing gear.

DESCENT

GENERAL

The high cruising altitude near the end of a mission can be converted into additional range by using correct descent procedure. The general rule to follow is to avoid early descent. Since turbojet fuel consumption is excessive at low altitude, even at idle RPM, a premature descent will result in a loss in range.

NORMAL DESCENT

The following procedure is recommended for a normal descent when there is no requirement for maximum range. The time required for this descent from 70,000 to 20,000 feet is approximately 18 minutes and the distance is approximately 100 nautical miles under zero wind condition. See APPENDIX I, Part 7 for more exact information.

1. Extend the speed brakes.
2. Lower the landing gear.
3. Retard throttle to idle stop with P-37 engine. (With P-31 engine, use the minimum pressure ratio schedule from SECTION V.)
4. Gust control remains FAIRED above 45,000 feet. Gust control to GUST below 45,000 feet.
5. Make the descent at an IAS 5 knots below the warning needle (0.77 Mach) until reaching 160 knots IAS. This is the optimum condition for encountering turbulence. If turbulence is present or anticipated, continue the descent at 160 knots IAS. If the air

is smooth, increase the speed to 200 knots IAS and continue the descent.

FAST DESCENT

In order to make a rapid descent, the following procedure is used. The time required for this descent from 70,000 to 20,000 feet is approximately eight minutes and the distance is approximately 50 nautical miles with zero wind.

1. Extend the speed brakes.
2. Lower the landing gear.
3. Retard throttle to idle stop with P-37 engine. With P-31 engine, use the minimum pressure ratio schedule from SECTION V.
4. Gust control remains FAIRED above 45,000 feet. Gust control to GUST below 45,000 feet.
5. Make the descent with needles together (0.80 Mach) until reaching 40,000 feet altitude, then descent at approximately 240 knots.

WARNING

1. During descent, care must be exercised that the airspeed limitations are not exceeded or structural failure may result. As the indicated speed builds up at lower altitudes, the gust control must be shifted to GUST position before reaching the placard speed of 220 knots IAS. The speed warning system, if installed, will sound the warning horn and automatically extend the speed brakes at approximately 220 knots IAS, providing electrical power is available.
2. At lower altitudes be aware of the possibility of turbulence and be prepared to slow down to rough air placard speed. Be careful not to exceed "g" limitations in flattening the angle of dive.

MAXIMUM RANGE DESCENT

In order to obtain maximum range, remain at cruise altitude until approximately 75 nautical miles from the landing base. Then start a "fast descent" as described above for a straight in approach. This will bring you to pattern altitude at the field. In using this procedure, only a small increase in range is realized; however, premature descent may cause a loss in range due to encountering headwinds.

EMERGENCY FAST DESCENT

Refer to SECTION III for information on this subject.

CONTROLLABILITY

During descent, if the speed is allowed to get 5-10 knots above the Mach warning needle, buffeting and tuck will be noted and can be corrected for by slowing down. If in a turn at the time, decrease angle of bank. See SECTION VI for complete information on flight characteristics.

CAUTION

Never extend the wing flaps above 45,000 feet since dangerous pitching moment effects are produced.

DESCENT CHECK

Accomplish descent in accordance with the following procedures to insure safe aircraft operation and to preclude damage to special equipment:

1. Altimeter - RESET TO STATION ALTIMETER SETTING.
2. Oxygen - PUSH-TO-TEST.

Check your oxygen and pressure suit by use of PUSH-TO-TEST before retarding throttle for descent.
3. Defroster - ON.
4. Pitot heat - ON (if required).
5. Landing gear - EXTENDED.
6. Speed Brakes - EXTENDED.
7. Throttle - IDLE (P-37)
MIN PR (P-31)

Minimum engine pressure ratio values for P-31 engines are contained in SECTION V.

8. Airspeed schedule - MAINTAIN.

Maintain appropriate speed schedule for the type of descent being made.

- a. Normal descent - Descent 5 knots below warning needle (0.77 Mach) until reaching 160 knots IAS and then maintain 160

(rough air), 200 knots (smooth air).

- b. Fast descent - Descend with needles together (0.80 Mach) then maintain 240 knots IAS.

9. Special equipment - SET.

Set as briefed or as indicated by special equipment checklist.

10. Gust control - GUST, AT 45,000 FEET.

11. Equipment mode selector - OFF.

12. Face heat - OFF AT 10,000 FEET CABIN ALT.

13. Face plate - REMOVED AND STOWED.

Remove and stow in bag below cabin altitude of 10,000 feet.

14. Oxygen valves - OFF.

Turn both valves off.

5,000 FOOT CHECK (DESCENDING)

1. Low altitude escape lanyard - HOOKED.

If flying with an ejection seat, hook lanyard to parachute "D" ring.

2. Fuel counter - CHECKED, SPEED COMPUTED.

Check the fuel remaining and determine the threshold speed for landing approach. The correct threshold speed can be obtained from Part 8 of the APPENDIX as a function of fuel remaining.

CAUTION

When gusty wind conditions exist, add 10 knots to the threshold speed to provide a safe margin.

3. Gust control - FAIRED.

Reduce speed to approximately 160 knots or slower if air is turbulent and place the gust control in the FAIRED position.

CAUTION

Always monitor the wing flap position indicator when shifting from GUST to FAIRED. If the flaps do not stop at the faired position, return switch to GUST.

4. Lateral trim - CHECKED.

As speed is reduced, check the lateral trim by noting the control wheel position. (Should be the same as it was on the after take-off trim check.) Correct for any wing heaviness by transferring fuel from the heavy wing before landing.

NOTE

The lateral trim check should be made with the wing flaps UP (Faired) and after 3 minutes of straight flight. A descending attitude does not affect the check.

BEFORE LANDING

Although the airplane is not difficult to land, it does have certain characteristics that differ from other jet aircraft. It is essential that the pilot have a thorough knowledge of these characteristics in order to be able to accomplish landings with a high degree of precision and safety under all runway and weather conditions.

With wing flaps up the total drag is so low that the airplane will maintain level flight at pattern altitude with engine speed only a few percent above idle. Even with landing gear and partial wing flaps extended, the glide angle is shallow, necessitating a flat approach. However, with full flaps a power approach can be made with as much as 85% engine RPM. Upon reducing power to idle, touch down will occur with a minimum float distance when using the proper threshold speed.

NOTE

There is no loss of rudder or aileron effectiveness due to using full flaps. However, there is slightly more buffeting at times and slight directional hunting in rough air. This is not considered objectionable.

A typical landing pattern, using the 360° overhead approach, is shown in Figure 2-2. This pattern is satisfactory for any wing flap setting except zero. In making a flaps up landing, all pattern altitudes should be halved or the pattern greatly enlarged. The use of full flaps is recommended since it makes for a more normal approach, shorter float distance and shorter ground roll.

INITIAL APPROACH

Enter on initial with sufficient engine RPM to maintain threshold speed plus 30 knots at an altitude of 1,500 feet above terrain.

INITIAL APPROACH
3 MILES FROM RUNWAY
1500 FT. ABOVE TERRAIN
THRESHOLD SPEED + 30 KTS

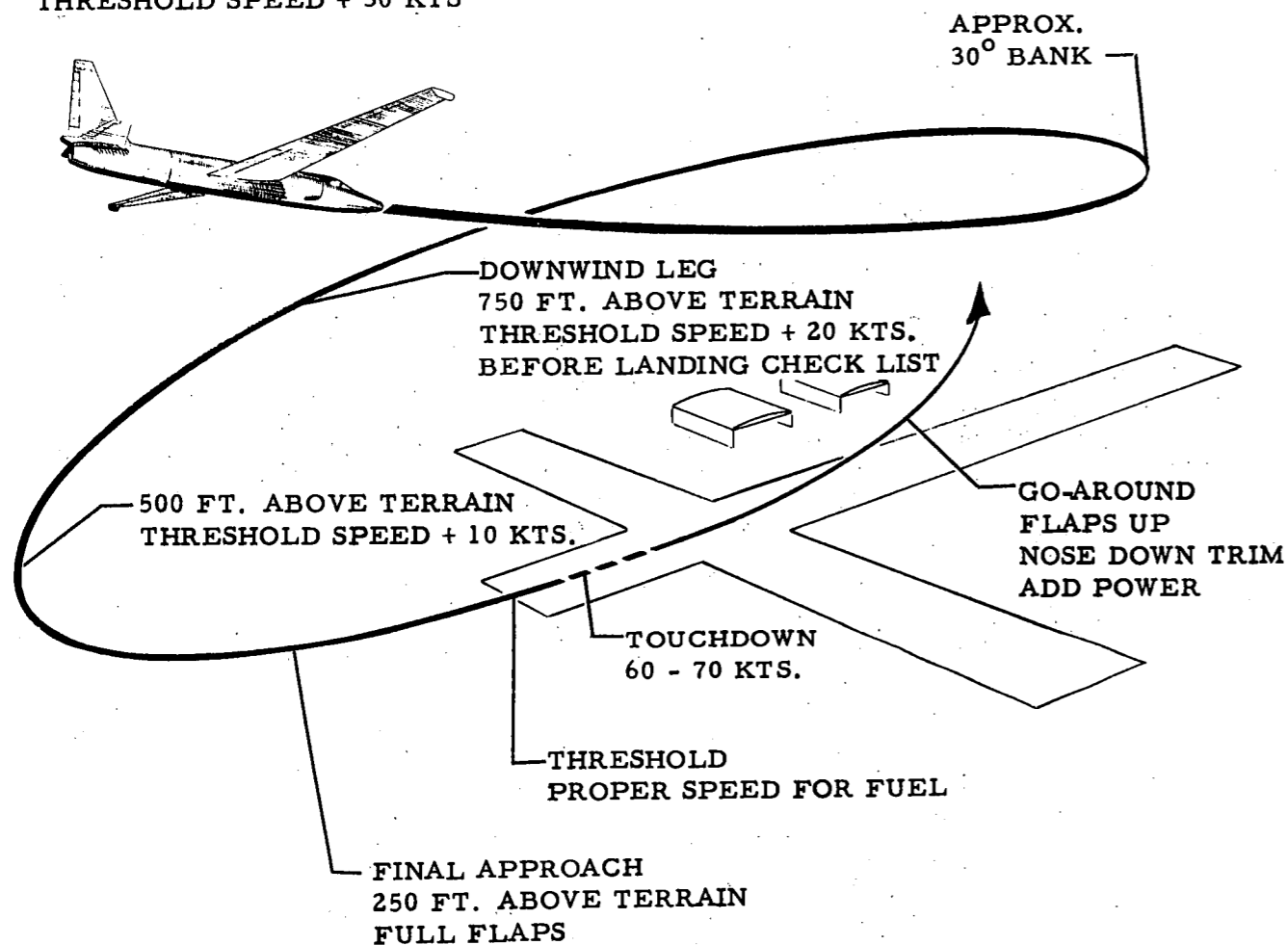

NORMAL LANDING PATTERN
FIG. 2-2

~~SECRET~~

180° TURN TO DOWNWIND LEG

At a point near the end of the runway, the exact location of which will be determined by traffic density and headwind conditions, begin a slow descending turn of approximately 30° bank to enter the downwind leg. Slightly reduce engine RPM or extend partial wing flaps.

DOWNWIND LEG

Roll out on downwind leg with enough power to maintain threshold speed plus 20 knots. At a point opposite the selected touchdown point, the altitude should be approximately 750 feet above the terrain. The before landing checklist shall be accomplished as soon as possible after turning on to downwind leg.

BEFORE LANDING CHECK

NOTE

Asterisk items are normally called in to a ground supervisor or other designated agency.

- *1. Landing gear - CHECKED DOWN AND LOCKED.

Recheck landing gear down and locked using the landing gear position indicators, landing gear unsafe warning horn and landing gear unsafe warning light.

2. Gust control - FAIRED.
3. Speed brakes - EXTENDED.
4. Wing flaps - SET.

Opposite approach end of runway extend wing flaps to desired position for landing.

WARNING

The wing flap extension placard speeds must be carefully observed since operation at too high a speed may result in structural failure of the horizontal stabilizer.

5. Control wheel - RECHECK.

Determine the fuel load is evenly balanced by checking the control wheel position.

- *6. Threshold speed - RECHECKED.

Check fuel quantity and recheck computed threshold speed.

~~SECRET~~

7. Landing lights - AS REQUIRED.

180° TURN TO FINAL APPROACH

Roll into the 180° turn to final approach and decrease the speed to threshold speed plus 10 knots. The more flaps used, the more power required to maintain proper speed, making it easier to judge the touchdown point when power is reduced. The altitude midway around this turn should be approximately 500 feet above the terrain.

FINAL APPROACH

The roll out onto final approach should be completed at approximately 250 feet and at threshold speed. This speed shall be maintained to the threshold point (this point is the end of the active runway) where the throttle is placed in idle. The altitude at the end of the runway should not exceed 10 feet.

NOTE

It is important that the airplane be brought to the threshold with the proper speed and altitude.

LANDING

TOUCHDOWN

Touchdown should be made on the main and tail gears together. In order to do this, the airplane must be flown down to a height of one foot above the runway. As the speed bleeds off, the tail will come down until the airplane settles onto the ground if the main gear has been held off long enough. When using full flaps, most of the excess speed can be bled off during the final 10 feet of descent and the airplane will reach the ground level just a few knots above touchdown speed.

WARNING

Extreme care must be used to correct for the least bit of drift just prior to touchdown. If the main and tail gears are aligned with the direction of landing at touchdown, directional control problems on the runway are simplified.

The main gear is well forward of the center of gravity position and if allowed to touchdown first, a skip will normally occur. This usually is a result of too much speed and not holding the aircraft off long enough. To correct from a skip, hold whatever elevator control you have already applied and when the aircraft begins to settle towards the runway again, resume the application of normal back pressure. When a bounce occurs on landing, it usually is the result of allowing the aircraft to abruptly contact the runway main gear first. A bounce can result in a dangerous situation and the best corrective action is to

immediately start applying power and initiate a go-around. If a go-around is impossible, give a slight forward pop with the elevator control to return the aircraft closer to the runway and to avoid encountering a stall condition. This action should be immediately followed by a continuation of a landing flareout so as to prevent a second contact with the runway main gear first.

CAUTION

1. If a bounce should degenerate into a porpoise, a go-around should be initiated immediately since a porpoise can cause aircraft structural damage.
2. If the flareout is made too high above the runway or in gusty air, a wing may drop and the airplane will yaw. This requires an immediate correction with aileron and rudder. If immediate contact is made with the ground, the corrections must be removed very quickly. Holding a steering correction in too long will cause a ground loop.

NORMAL LANDING RUN

After touching down, the wings should be held level with aileron only, and directional control maintained with the rudder. Do not attempt to raise a wing by steering into it while on the high speed portion of the roll. There is danger of over-steering and causing a ground loop. The important factor is to keep the airplane going straight. The landing roll can be reduced by leaving the wing flaps full down, but if the wind is in excess of 30 knots and/or gusty, raise them immediately after touchdown. Do not extend flaps immediately after touchdown if landing has been made with less than full flap, to preclude the possibility of becoming airborne again.

After touchdown, exercise caution in aft movements of the control column. By making fast or abrupt movements to the rear, it is possible to pull the aircraft back into the air in a nose high attitude.

NOTE

The control column must be held in the aft position to hold the tail wheel in firm contact with the runway in order to assure adequate directional control during the landing roll.

Avoid heavy braking to prevent tire and brake damage. Ordinarily the brakes are moderately applied when the airplane has decelerated to approximately 50 knots; then when it is decided to stop at approximately 30 knots, they are applied moderately hard if wings are level, and lightly if one wing is on the ground.

NOTE

Care must be exercised in applying the brakes when one wing is low. Under this condition, the main gear tire on the high wing side is lightly loaded and as brake pressure is applied, this wheel is easily skidded, causing a flat spot or a blowout.

Ailerons should be used to hold the wings level as long as possible. This requires light force but quick action. As aircraft slows down, full aileron may be required. One wing will drop to the runway when speed diminishes and the aircraft should be stopped soon thereafter; however, the aircraft can still be turned either direction. Normally, a wing tip dragging on a hard surface will not be harmful to the aircraft at light fuel loads.

CAUTION

Make certain that the wing tips are clear of obstructions before the skid contacts the ground.

CROSS- WIND LANDING

A cross-wind landing can be accomplished with wind velocity and direction that results in a runway cross-wind component of 15 knots or less.

CAUTION

Do not attempt a normal cross-wind landing if more than three quarters of the rudder travel is applied to correct for wind drift just prior to touchdown.

Successful landings, with full rudder application to correct for drift, can be accomplished with runway cross-wind component of 20 knots because tail wheel steering will help when on the ground. However, landings under these conditions should only be considered in actual emergencies when no suitable runway more nearly aligned with the wind is available.

NOTE

1. Do not land using "crab" techniques.
2. Do not make a full stall landing in a cross-wind.

Landing With Cross- Wind Component Up To 15 Knots

- a. Runway alignment should be maintained by slipping, utilizing a combination downwind rudder and enough bank into the wind to maintain heading and prevent aircraft drift. The bank angle required is slight for 3/4 rudder application.
- b. Once the aircraft has touched down, rudder control only should be sufficient to maintain directional alignment with the runway. If difficulty is encountered, use the technique described below.

Landing With Cross- Wind Component in Excess of 15 Knots

After landing with cross-wind components in excess of 15 knots, keep the upwind wing just above the ground until loss of directional control, then put downwind wing on the ground. The additional drag of the downwind wing skid coupled with available rudder control and steering will permit a safe landing.

HEAVY WEIGHT LANDING

Since the design landing weight of the airplane is 11,600 lbs. (46 gal.), most landings are made at weights in excess of the design landing weight. At the nominal landing weight of 15,000 lbs., or approximately 550 gallons of fuel remaining, reasonable care in landing will not result in any structural difficulty. However, if it is not possible to burn out excess fuel and a landing is necessary at a still heavier weight, every effort must be made to make as smooth a landing as possible. In order to avoid structural damage to the landing gear, the rate of sink at touchdown must be reduced to a minimum.

CAUTION

Be careful not to cause a bounce and then allow the airplane to stall and drop in. Stalling speed will be correspondingly higher due to the heavier weight. The stall warning buffet will be less noticeable.

NIGHT LANDING

The technique for accomplishing night landings is essentially the same as for daylight landings. A skip or bounce landing can cause more difficulty at night because it is harder to ascertain the height of the skip and the necessary correction.

NOTE

1. The sextant filter knob should be out (filter in place) for night landings, to preclude the possibility of the landing lights shining through the drift sight head and into the pilot's eyes.
2. The landing gear should never be retracted with the landing lights turned on since they will burn out in a short time without cooling.

LANDING WITH DRAG CHUTE DEPLOYMENT

The use of the drag chute is not necessary for a normal landing, but it will materially reduce float distance and landing roll. This will permit the use of

shorter runways and/or steeper approaches as the tactical or emergency situation may dictate. The landing approach should be planned the same as for a no chute landing so that if for some reason the chute doesn't deploy, the landing can be completed.

Desired procedure is to deploy the drag chute between 5 and 10 feet above the approach end of the runway at the threshold speed for a given weight and configuration as shown in the APPENDIX. If a go-around is necessary, jettison the drag chute. In any case, with chute out and full power on, it will disintegrate.

When deployed at moderate gross weights, the drag chute will feel light and there will be ample time to flare. When deployed at light gross weights, the drag is very noticeable and will require an immediate flare because touchdown will occur much sooner. When using the chute on a heavier than normal landing, wait until the airplane is on the ground before deployment.

If the drag chute is deployed between zero and five feet above the runway at slightly high speed, it is very easy to balloon too high in correcting for drag due to the chute. If the drag chute is deployed between zero and five feet above the runway at slightly slow speed and particularly light weights, it will be almost impossible to keep from hitting nose wheel first. However, the chute will stop any porpoise that starts.

It is not necessary to jettison the chute before taxiing. However, when desired, it can be jettisoned at approximately 20 knots or after stopping by momentarily increasing throttle. The chute has to be blossomed to jettison properly.

CAUTION

1. When deployed at too high an altitude and too slow a speed, the drag chute will cause excessive rates of sink from which it may be impossible to flare.
2. Do not deploy the drag chute in a cross-wind with a component greater than 10 knots.
3. The drag chute may not come out of the container when deployed with the engine shut off or after touchdown due to insufficient pilot chute drag.

MINIMUM RUN LANDING

The minimum run landing is accomplished by proper use of the following procedures:

1. Extend full wing flaps on approach and leave down.
2. Consider the threshold to be 500 feet prior to the end of the runway. Establish proper threshold speeds and altitude at this point.

3. Deploy the drag chute over end of runway and leave on until stopped.
4. Use the brakes earlier and harder than normal.
5. Shut off the engine as early as possible. This will normally mean immediately after touchdown; however, the engine may be shut down at the threshold if lack of available runway should dictate this procedure. Engine idle thrust is a large factor in length of float distance and ground roll.

CAUTION

If the decision is made to shut down the engine at threshold, extreme care is required during the touchdown since engine power is not available to go-around.

GO-AROUND

Due to the large amount of excess thrust, the airplane has an outstanding ability to perform a go-around. This maneuver is easily accomplished by following the proper procedures. The application of power causes a moderate nose up trim change. This must be compensated by application of nose down trim and moderate control push forces. It is not necessary to retract the wing flaps to reduce airplane drag, but they are usually retracted in order to eliminate the need to observe the flap placard speed. Retraction of the wing flaps also causes a light nose up trim change. It is not necessary to retract the landing gear or speed brakes.

Before Touchdown

If the decision is made to go-around while still in flight, the following procedures are used:

1. Apply the power as rapidly as desired. Resist the trim change.
2. Wing flaps may be retracted immediately since the airplane will be accelerating and altitude loss due to flap retractions will be negligible.

After Touchdown

If the touchdown has been made, use the following procedures:

1. If time permits, start the wing flaps up.
2. Start application of nose down trim.
3. Advance the power rapidly to 85% RPM. As aircraft speed increases

and elevator control becomes effective, increase power as desired. Do not allow the nose to rise abruptly upon breaking ground.

CAUTION

Do not exceed the wing flap placard speed of 130 knots IAS with flaps extended.

TOUCH AND GO LANDINGS

Touch and go landings with fuel loads of 300 gallons or less are authorized in this aircraft and can be routinely accomplished without difficulty. Takeoff acceleration is rapid and runway length is not a critical factor during touch and go operations. After normal touchdown, the aircraft should be allowed to decelerate to 50 knots, at which time the flaps should be retracted and the elevator trim reset toward the neutral position. Due to the slow rate of change in position of the elevator trim tab, approximately 15 to 25 seconds will be required to obtain neutral trim position. Usually it is sufficient to apply nose down trim during the time required for the flaps to retract. When the takeoff is initiated, engine power should be advanced to at least 85% RPM and the control column placed forward of the neutral position to raise the tail approximately 1 foot above the runway. As takeoff speed is reached, gently apply back pressure to the control column to fly the aircraft from the runway. Until experience is gained in the aircraft, considerable attention is required to prevent excess speed. There is a common tendency to gain excess altitude in the closed traffic pattern. When making a closed pattern, use the "Before Landing Check" after turning downwind.

CAUTION

A combination of excessive power application and use of full forward control column movement will result in the aircraft becoming airborne and flying back onto the runway before sufficient elevator back pressure can be obtained to keep the aircraft airborne.

TAXIING WITHOUT POGOS AFTER LANDING

The aircraft can be easily taxied without pogos installed, even with a crosswind component of 20 knots. It is possible to turn the aircraft and come to a stop downwind under these conditions. If it is desired to taxi the airplane off the active runway after landing, the following procedure can be used:

1. Slow the aircraft to 30 to 40 knots.
2. Jettison the drag chute.
3. Add a slight amount of power to maintain speed.

To aid in turning 90 degrees with minimum radius, hold the wing low on the side of the desired turn for at least 1000 feet prior to turning. This keeps the desired wing tip on the ground during the turn since the fuel will have run outboard. If this is not done, centrifugal force in the turn will throw the outside wing down and increase the turn radius. The minimum turning radius is approximately 150 feet. Take full advantage of intersections by getting to opposite edges and cutting the inside corner of the intersection. Take care not to hit runway and taxi lights with the wing.

AFTER LANDING

This checklist should be completed as soon as possible after the landing is completed and the aircraft brought to a stop:

1. Equipment master switch - OFF.
2. Hatch heaters - OFF.
3. Pitot heater - OFF, IF APPLICABLE.
4. Radio compass - OFF.

AFTER PARKING

This check should be completed as soon as possible after the aircraft is parked:

1. Anti-collision lights - OFF.
2. Cockpit defroster fan - OFF.
3. UHF radio - OFF.
4. Canopy defroster - OFF.
5. Canopy seal and equipment bay seal valves - OFF.
6. Flaps - FULLY EXTENDED.
7. Throttle - OFF.

Shut down the engine upon signal from crew chief or when desired by pilot.

8. Inverter - OFF.
9. AC Alternator - OFF.
10. Battery-Generator - OFF.

11. Canopy - UNLOCKED AND OPEN.

After engine has completely stopped rotation, unlock the canopy with the right canopy handle and open the canopy with upward pressure on the right side.

12. Ejection seat initiator safety pin - INSTALLED.

A ground crew member will install the seat pin in the initiator located on lower right hand corner of ejection seat.

13. Personal equipment - UNHOOKED.

An assistant will help in unhooking the pilot's personal equipment.

14. Form 781 - COMPLETED.

Write up all discrepancies in detail.

CONDENSED CHECKLIST

Pages 2-47 through 2-62 contain a condensed checklist.

U-2 CONDENSED CHECKLIST

NOTE

The following checklist is a condensed version of the aircraft checklist.

PRELIMINARY COCKPIT CHECK

1. Seat ejection system - Check.
2. Form 781 - Checked for aircraft status.
3. Battery switch - Off.
4. Autopilot controller, sextant viewing scope and driftsight control panel - Proper installation and function.
5. Radio facility chart, appropriate letdown books - Present and current.
6. Rubber sextant scope cover - In place.
7. Sun shade - Securely fastened.
8. Fan - Securely mounted.
9. Climb data card - Installed.
10. Under seat and behind rudder pedals - Check for loose items.
11. Relief tube - Installed and secured.
12. Fuel totalizer - Check.
13. Oxygen quantity - Check for 1800 PSI minimum.
14. Surge bleed valve sump overflow and gust control lights for night operation - Lights taped.
15. Equipment bay upper hatch locking handles - Check.

U-2
1 March 1959

1

U-2
1 March 1959

2

EXTERIOR INSPECTION

A. MAIN LANDING GEAR AREA

1. Tracker cover - Removed when applicable.
2. Tires - Examined for inflation and excessive wear.
3. Landing gear downlock pin - Installed.
4. Chocks - In place.
5. Hydraulic lines - Check for leaks.
6. Shock strut - Check for 3/4" to 1 1/4" of chrome showing above red bottoming strip.
7. Circuit breakers - Check that C. B. 's located in wheel well are not popped or pulled. (Not applicable to all aircraft.)
8. Landing gear doors and locking levers - Good condition and secure.
9. Landing lights - Check for breakage and security of mounting.
10. Hydraulic reservoir door - Check securely closed.
11. Oil cooler scoop - Clear of obstructions.

B. FUEL TANK CAP CHECK - CAPS TIGHTENED.

C. RIGHT WING

1. Leading edge - Check for cracks, dents or other visible damage.
2. Pogos - Installed and locking pins in.
3. Lower wing surface - Check for wrinkles, fuel leakage or wet areas, lower surface of flaps and ailerons for condition.

4. Wing tip skid - Clear of aileron during aileron movement.
5. Aileron - Inspect for freedom of movement and general condition, and condition of fixed trim tab.
6. Flap - Down, drive shafts and piano hinge wire inspected.

D. RIGHT REAR FUSELAGE

1. Speed brake - Out, hydraulic actuator and hydraulic lines checked for security and hydraulic leaks.
2. Speed brake area of fuselage - Inspect for cracks, wrinkles, rolled rivet heads and oil seepage around rivet heads.
3. Anti-collision lights - Check for broken lenses.
4. Tail wheel - Inspected for down lock pin installation and steering scissors connected. Check tail wheel tires for condition.
5. Shock strut - Check for 1 1/2" to 2" of chrome showing above red bottoming strip.

E. EMPENNAGE

1. Leading edge of right horizontal stabilizer - Check for warping or visible damage.
2. Leading edge of vertical stabilizer - Check for warping, wrinkles, or visible damage.
3. Right elevator - Freedom of movement, security of hinges, security of trim tab, and general condition of elevator.
4. Drag chute doors - Check door lock in locked position.

U-2
1 March 1959

3

U-2
1 March 1959

4

5. Rudder - Visible damage, warping, freedom of movement.
6. Rudder trim tab - Check condition and for warping.
7. Tailpipe - Check condition of turbine and tailpipe.
8. Fuel vent - Check for obstructions.
9. Left elevator - General condition, security of hinges and security of trim tab.
10. Leading edge of left horizontal stabilizer - Check for warping and visible damage.

F. LEFT REAR FUSELAGE

1. Speed brake - Out, hydraulic actuator and hydraulic lines for security and hydraulic leaks.
2. Speed brake area of fuselage - Inspect for cracks, wrinkles, rolled rivet heads and oil seepage around rivets.

G. LEFT WING

1. Left wing flap - Down, drive shafts and piano hinge wire inspected.
2. Aileron - Inspect for freedom of movement and general condition. Check adjustable trim tab for condition and security.
3. Wing tip skid - Clear of aileron during aileron movement.
4. Pogo - Installed and locking pins in.
5. Lower wing surface - Check for wrinkles, fuel leakage or wet areas, lower surface of flaps and ailerons for condition.
6. Leading edge - Check for cracks, dents or other visible damage.

H. NOSE SECTION

1. Left engine air intake duct - Free from obstructions and foreign objects. Engine compressor blades free of dents and nicks.
2. Lower equipment bay hatch locking indicator (Left Side) - Locked.
3. Upper equipment bay hatch locking indicator (Left Side) - Locked.
4. Free air temperature probe - Check for security.
5. Sextant dome cover - Removed.
6. Left static ports - Clear of obstructions.
7. Pitot head - Cover removed, pitot tube clear.
8. Drift sight dome - Cover removed, free of dirt.
9. Right static ports - Clear of obstructions.
10. Lower equipment bay hatch locking indicator (Right Side) - Locked.
11. Upper equipment bay hatch locking indicator (Right Side) - Locked.
12. Right engine intake duct - Free from obstructions and foreign objects. Engine compressor blades free of dents and nicks.

PRIOR TO BOARDING AIRCRAFT

1. Form 781 - Checked by pilot and Part 2 signed.
2. Seat pack quick disconnect and connections - Recheck properly connected to aircraft systems and safety clips attached.
3. Shoulder straps and safety belt - Fully extended to facilitate pilot hookup.
4. Parachute - Fitted to pilot.

U-2
1 March 1959

5

U-2
1 March 1959

6

5. Partial pressure suit capstan and breathing bladder hoses - Extended and free of parachute harness. (Applicable for high altitude flight only.)

PILOT EQUIPMENT CHECK

A. PILOT EQUIPMENT CHECK - LOW FLIGHT

1. Seat blocks and back cushion - Installed as required.
2. Check aircraft oxygen supply - 1700 to 1850 psi.
3. Check oxygen supply in seat pack - 1800 psi.
4. Check for safety pin installed on quick disconnect of seat pack. If pin is missing, advise crew chief.
5. Pilot enters cockpit.
6. Connect face plate to seat mask hose.
7. Face plate amphenol plug - Connected and locked.
8. Capstan hose - Capped off from seat pack.
9. Seat pack - Connected to parachute on left side.
10. Seat pack - Connected to parachute on right side.
11. Green apple cable - Position under right lap belt and secure with strap and snap.
12. Connect shoulder harness to lap belt.
13. Attach F-1 release to lap belt and lock belt.
14. Low altitude escape lanyard - Attach to parachute "D" ring.
15. Radio bypass cord - Plug into helmet jack.
16. Install face plate - Check oxygen flow on primary and on secondary pressure reducers.
17. Face heat - Connect both normal and emergency face heat cords to face plate. Pull emergency face heat circuit breaker.

18. Auxiliary power - Connected and on.
19. Check face plate for heat and advise pilot to check radio.
20. Face plate removed - Oxygen off at both valves. Stow face plate in bag and place on left console.
21. Oxygen - Recheck aircraft and emergency oxygen supply.

B. PILOT EQUIPMENT CHECK - HIGH FLIGHT

1. Seat blocks and seat cushions - Installed as required.
2. Oxygen supply - Check aircraft oxygen supply 1700 to 1850 psi.
3. Oxygen supply - Check emergency oxygen supply to 1800 psi.
4. Quick disconnect - Check for safety pin installed on seat kit. Advise crew chief if missing.
5. Pilot enters aircraft - Connect to aircraft oxygen system. Primary system only - on.
6. Seat pack strap - Attach left seat pack strap to parachute and adjust.
7. Capstan hose - Connect to seat pack hose and install safety clip.
8. Bladder hose - Connect to seat pack hose and install safety clip.
9. Breathing hose - Connect to suit breathing connection and install clip.
10. Amphenol plug - Connected and locked.
11. Face heat - Attach emergency face heat cord to left side of face plate, circuit breaker pulled.
12. Seat pack strap - Attach right seat pack strap to parachute and adjust.
13. Green apple cable - Position under right lap belt and secure with strap and snap.

U-2
1 March 1959

7

U-2
1 March 1959

8

14. Harness - Connect shoulder harness to lap belt.
15. F-1 release - Attach to lap belt and lock belt.
16. Low altitude escape lanyard - Hooked to parachute "D" ring.
17. Radio bypass cord - Under left lap belt.
18. Face plate - Recheck locked and secure.
19. Press-to-test - Check for oxygen leaks and for suit inflation in 9 seconds.
20. Auxiliary power - Connected and on.
21. Secondary oxygen valve - On.
22. Primary oxygen valve - Off. Check that "PRIM OFF" oxygen warning light is illuminated. Check that low pressure oxygen gage reads approximately 70 psi.
23. Secondary oxygen valve - Turn off momentarily and check that the "LOW PRESS" oxygen warning light is illuminated. Turn valve back on to restore oxygen flow to the pilot.
24. Primary oxygen valve - On. With both valves on, check that both oxygen warning lights are out and that the low pressure oxygen gage reads approximately 80 psi.
25. Face heat - Check for face plate heat and advise pilot to check radio.
26. Oxygen - Recheck aircraft and emergency supply.

PILOT'S COCKPIT CHECK

1. Inverter - ON, LIGHT OUT.
2. MA-1 Compass - SLAVED.
3. Radio Compass - ANTENNA.
4. Flight plan - FILED.
5. Anti-collision light switch - ON.
6. Fan - CHECKED AND OFF.

7. Seal Valves - ON.
8. Landing lights - CHECKED AND OFF.
9. Emergency fuel shutoff - COVER DOWN.
10. Gust control - FAIRED.
11. Wing flap switch - UP.
12. Friction lock - ADJUSTED.
13. Throttle - OFF.
14. Speed brake switch - FORWARD.
15. Left canopy jettison handle - ALIGNED AND SAFETIED.
16. Oxygen pressure - CHECKED.
17. Gear handle - DOWN, WARNING SYSTEM CHECKED.
18. Fuel transfer switch - OFF.
19. Drag chute handle - IN.
20. Ram air switch - OFF.
21. Face heat - SET.
22. Cabin heat selector - AUTO.
23. Cabin temperature - SET.
24. Generator-battery switch - OFF.
25. Pitot heat - OFF.
26. AC Alternator switch - ON.
27. Master watch - INSTALLED.
28. Aircraft clock - SET.
29. Emergency face plate heat circuit breaker - PULLED.
30. All other circuit breakers - SET.
31. Fuel totalizer - SET.
32. Sump overflow light - ILLUMINATED.
33. Instrument and panel lights - SET.
34. Emergency fuel control switch - NORMAL.
35. Destructor - SAFETIED.
36. Push-to-test lights - CHECKED.
37. Autopilot - CHECKED AND OFF.
38. Equipment master switch - OFF.
39. Equipment mode selector - OFF.

U-2
1 March 1959

9

U-2
1 March 1959

10

40. Defroster - OFF.
41. Cover jettison switch - COVER DOWN.
42. Hatch heater switch - OFF.
43. Altimeter selector switch - EQUIPMENT BAY.
44. Trim power switch - ON.
45. Trim tabs - CHECKED AND NEUTRAL.
46. Rudder pedals - ADJUSTED.
47. Cockpit auxiliary lights - SET.
48. Flashlight - CHECKED.
49. Mission special equipment - SET.
50. Oxygen quick disconnect - CHECKED.
51. Suit connections - CHECKED.
52. Low altitude escape lanyard - HOOKED.
53. Face plate latch - LOCKED.
54. Emergency face heat cord - CONNECTED.
55. Green apple - SECURE.
56. Assistant disconnects headset and turns recorder switch OFF.
57. Radio bypass cord - STOWED.
58. Radio compass - CHECKED.
59. Canopy - CLOSED AND LOCKED.
60. Yaw string - FREE.
61. Ladder - REMOVED.

START ENGINE

1. Brakes - HOLD.
2. Starting unit - SIGNAL START.
3. Starting air - SIGNAL ON.
4. Throttle - IDLE.
5. Ignition Switch - START AND HOLD.
6. Ignition switch - RELEASE.
7. APU and starter air - SIGNAL DISCONNECT.
8. Generator-battery switch - GEN-BAT.

AFTER START

1. Idle RPM - CHECKED.
2. Engine instruments - CHECKED.
3. Flight instruments - CHECKED.
4. Wing flaps - UP.
5. Flight controls - CHECKED.
6. Fan - ON.
7. Generator-Battery - CHECKED.

BEFORE TAXIING

1. Anti-collision lights - Checked.
2. Camera window covers - Checked.
3. Engine access doors - Closed.
4. Landing gear pins - Removed.
5. Wheel chocks - Removed.
6. Route of taxi - Check clear and signal pilot clearance for taxi.

BEFORE TAKE-OFF

1. Radio call - COMPLETED.
2. Shoulder harness - LOCKED.
3. Canopy - CLOSED AND LOCKED.
4. Equipment master switch - ON. (If applicable)
5. Hatch heater switch - ON. (If applicable)
6. Pitot heat switch - AS REQUIRED.
7. Seat ejection safety pin - REMOVED.
8. Pogo locking pins - REMOVED.
9. Take-off clearance - OBTAINED.
10. Engine instruments - CHECKED.

U-2
1 March 1959

11

U-2
1 March 1959

12

11. Sump overflow light - OUT.
12. Brakes - RELEASED.

CLIMB CHECK

NOTE

Items 4 and 5 will be completed after passing 5,000 feet.

1. Landing lights - OFF.
2. Landing gear - UP, INDICATORS CHECKED.
3. Climb speed - 160 K
4. Low altitude escape lanyard - UNHOOK AND STOW.
5. Engine and flight instruments - CHECKED.
6. Aileron wheel position - NOTE.
7. Defroster - ON (P-31 engine).
8. Autopilot - ENGAGED.
9. Gust control - FAIRED.
10. Pressurization - CHECKED.
11. Oxygen quantity - CHECKED.
12. Oxygen system - PRESS TO TEST.
13. Altimeter - SET AT 29.92 ABOVE 45,000 FEET.
14. Equipment mode selector - STANDBY.
15. Special equipment - ON, AS BRIEFED.

DESCENT

1. Altimeter - RESET TO STATION ALTIMETER SETTING.
2. Oxygen - PUSH-TO-TEST.
3. Defroster - ON.

4. Pitot heat - ON (if required).
5. Landing gear - EXTENDED.
6. Speed brakes - EXTENDED.
7. Throttle - IDLE (P-37)
MIN PR (P-31)
8. Airspeed schedule - MAINTAIN.
9. Special equipment - SET.
10. Gust control - GUST AT 45,000 FEET.
11. Equipment mode selector - OFF.
12. Face heat - OFF AT 10,000 FEET CABIN ALT.
13. Face plate - REMOVED AND STOWED.
14. Oxygen valves - OFF.

5,000 FOOT CHECK (DESCENDING)

1. Low altitude escape lanyard - HOOKED.
2. Fuel counter - CHECKED, SPEED COMPUTED.
3. Gust control - FAIRED.
4. Lateral trim - CHECKED.

U-2
1 March 1959

13

U-2
1 March 1959

14

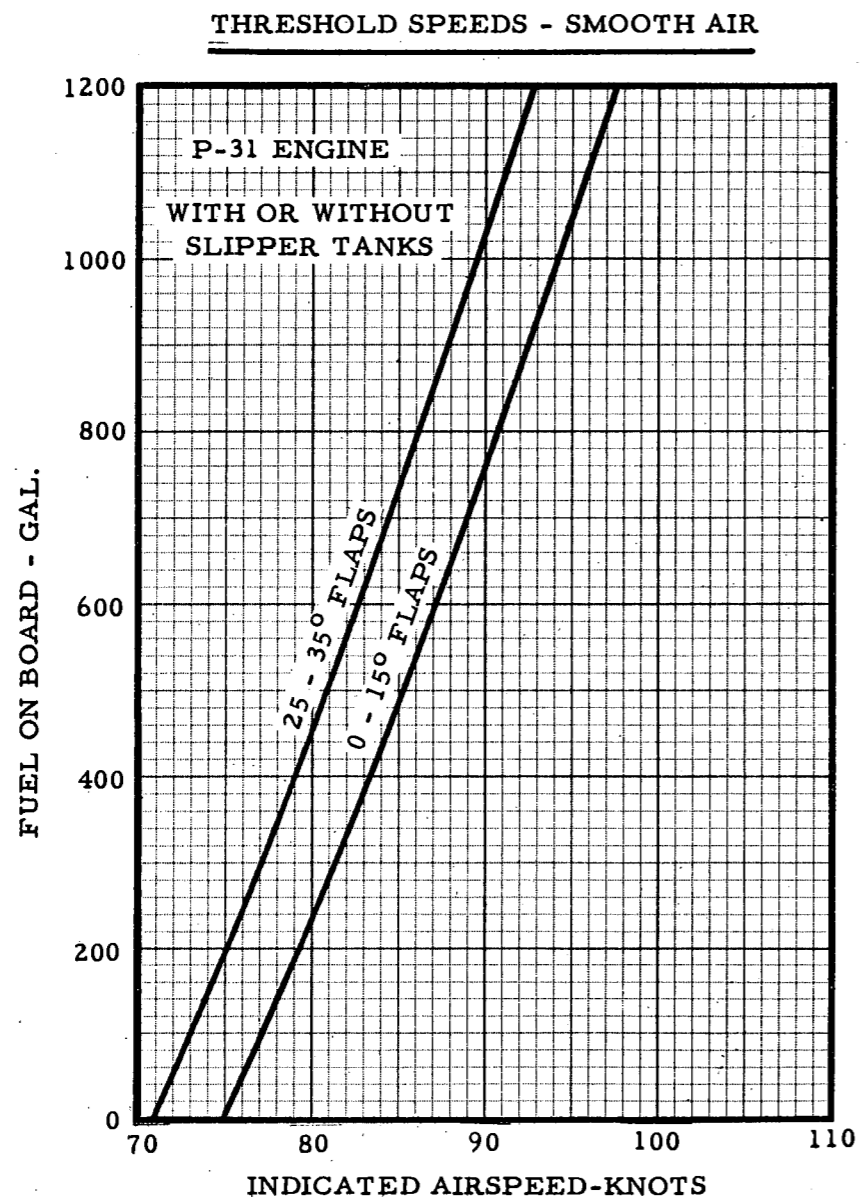

BEFORE LANDING

NOTE

Asterisk items are normally called in to a ground supervisor or other designated agency.

- *1. Landing gear - CHECKED DOWN AND LOCKED.
- 2. Gust control - FAIRED.
- 3. Speed brakes - EXTENDED.
- 4. Wing flaps - SET.
- 5. Control wheel - RECHECK.
- *6. Threshold speed - RECHECKED.
- 7. Landing lights - AS REQUIRED.

AFTER LANDING

- 1. Equipment master switch - OFF.
- 2. Hatch heaters - OFF.
- 3. Pitot heater - OFF, IF APPLICABLE.
- 4. Radio compass - OFF.

AFTER PARKING

- 1. Anti-collision lights - OFF.
- 2. Cockpit defroster fan - OFF.
- 3. UHF radio - OFF.
- 4. Canopy defroster - OFF.
- 5. Canopy seal and equipment bay seal valves - OFF.
- 6. Flaps - FULLY EXTENDED.
- 7. Throttle - OFF.

U-2
1 March 1959

15

U-2
1 March 1959

16

- 8. Inverter - OFF.
- 9. AC Alternator - OFF.
- 10. Battery-Generator - OFF.
- 11. Canopy - UNLOCKED AND OPEN.
- 12. Ejection seat initiator safety pin - INSTALLED.
- 13. Personal equipment - UNHOOKED.
- 14. Form 781 - COMPLETED.

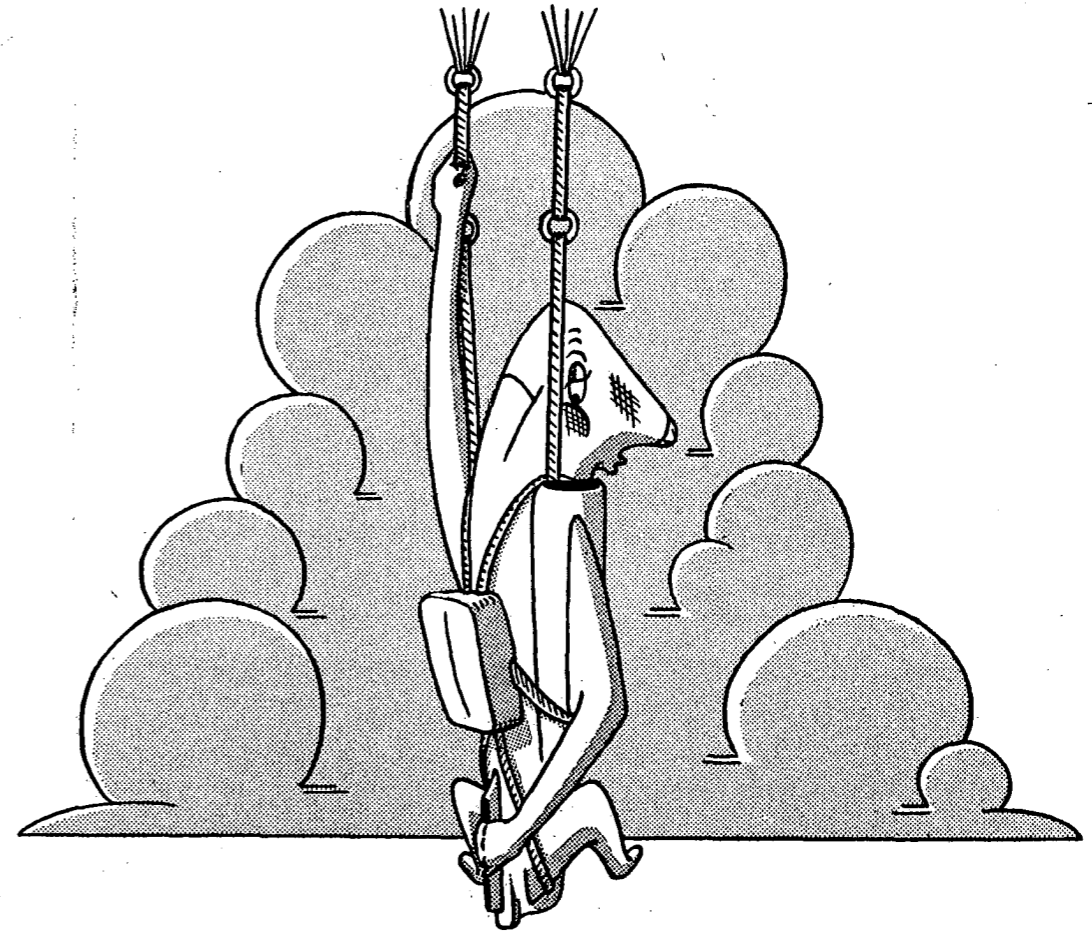

3

TABLE OF CONTENTS

	PAGE
ENGINE FAILURE	3-2
AIRSTART	3-7
ENGINE FUEL SYSTEM MALFUNCTION.....	3-8
FLAME-OUT LANDING PROCEDURE	3-9
LANDING EMERGENCIES	3-13
EMERGENCY DESCENT	3-15
FIRE	3-16
COCKPIT FOG OR SMOKE ELIMINATION.....	3-17
EMERGENCY CANOPY REMOVAL	3-18
BAILOUT.....	3-18
OXYGEN SYSTEM MALFUNCTION	3-20
HYDRAULIC SYSTEM EMERGENCY OPERATION	3-21
LANDING GEAR EMERGENCY EXTENSION	3-21
AIRCRAFT FUEL SYSTEM MALFUNCTION	3-21
ELECTRICAL SYSTEM MALFUNCTION	3-23
ENGINE OIL SYSTEM MALFUNCTION	3-25
TRIM TAB MALFUNCTION.....	3-25
GUST CONTROL MALFUNCTIONS.....	3-25
WING FLAPS MALFUNCTION	3-26
AIR CONDITIONING MALFUNCTION	3-26
PRESSURIZATION EMERGENCY OPERATION...	3-27
FACE PLATE HEAT FAILURE.....	3-27
COMMUNICATIONS FAILURE.....	3-27
POGO RELEASE FAILURE	3-27
CONDENSED CHECK LIST.....	3-27

SECTION

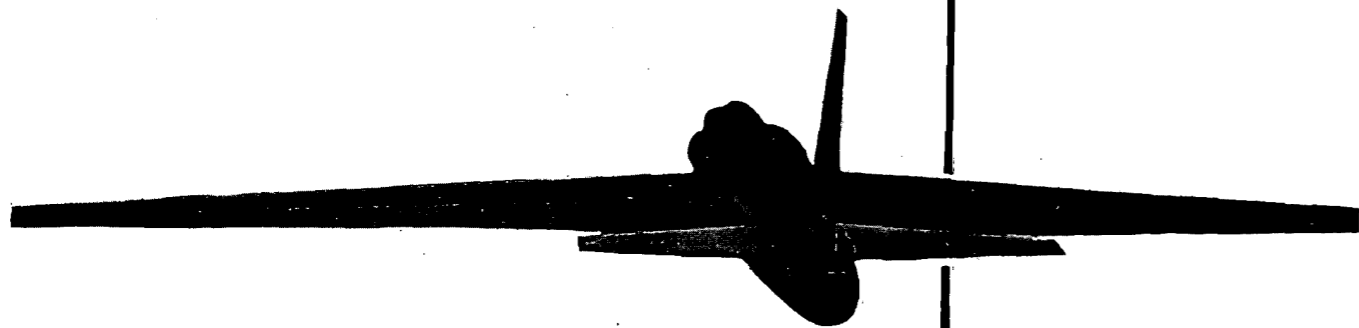

EMERGENCY PROCEDURES

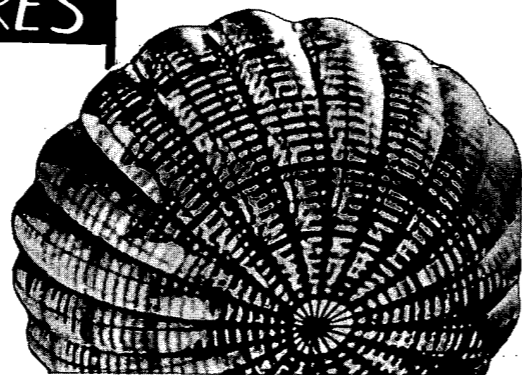

ENGINE FAILURE

GENERAL

The majority of engine malfunctions in this aircraft are flameouts at high altitudes. Flameout may be caused by stoppage of the fuel boost pump or its hydraulic drive motor. In this event a restart can be accomplished. Other flameouts are caused by engine compressor stall and are usually accompanied by a loud "bang - bang" noise. This banging does not harm the engine. Compressor stall may be caused by improper throttle management, allowing the air-speed to drop too low, failure to observe pressure ratio limits and other causes. If flameout is due to the above conditions a restart can usually be accomplished. This type of difficulty is more prevalent with the J57-P-37 engine than with the J57-P-31 engine. If a flameout is caused by mechanical or material failure within the engine a restart may be possible, depending on the seriousness of the failure, and flight continued at lower power settings and altitudes.

The flight characteristics with a dead engine are normal and rapid trim revisions are not necessary. The glide ratio is approximately 23 to 1.

COMPLETE POWER FAILURE BEFORE LEAVING THE GROUND

In the event of a complete power failure during the takeoff ground roll, an abort must be initiated promptly. All available drag devices must be utilized due to the low drag of the aircraft. Accomplish as much of the following as possible:

1. Throttle - OFF.
2. Speed brakes - EXTENDED.
3. Drag chute - DEPLOYED.
4. Brakes - APPLIED.
Use brakes as much as possible without sliding the tires.

5. If a crash is imminent, accomplish the following:

- a. Canopy - JETTISON
- b. Landing gear lever - UP.

NOTE

It will be necessary to depress the landing gear lever lock release while raising the lever in order to retract the landing gear.

- c. Main fuel shut off valve - CLOSED. (guard up)
- d. Generator - battery - OFF.
- e. Evacuate the aircraft immediately after it stops.

COMPLETE POWER FAILURE IMMEDIATELY AFTER TAKEOFF

If a complete power failure should occur after leaving the ground, the procedures for effecting a safe landing will depend upon the position of the aircraft relative to the runway. The airspeed, altitude, and length of remaining runway will directly affect the pilot's decisions. Should engine failure occur when the aircraft is several feet in the air, land straight ahead if possible. If there is sufficient altitude to maintain directional control, it may be possible to land the aircraft on another runway or in an adjacent field. A wheels down landing without power is made the same way as a normal landing. For a wheels up landing insure that the aircraft touches at a slightly higher speed than for a normal landing, so that the aircraft contacts the ground in a level attitude. If a power failure occurs after leaving the ground, accomplish as much of the following as possible:

1. Maintain a safe flying speed and control until contact is made.

NOTE

The following minimum safe speeds (10 kts above stall) are recommended for the accompanying take off fuel loads.

<u>FUEL LOAD (GALS.)</u>	<u>MINIMUM SAFE FLYING SPEED (kts IAS)</u>
1535	105
1335	101
1035	96
885	93
685	90

2. Try Restart.
If time permits try a restart. If unsuccessful, switch to emergency, and try another restart.
3. Throttle - OFF.
If restarts are unsuccessful.
4. Landing Gear - DOWN
5. Speed brakes - Use as required.
6. Wing Flaps - Use as required.
7. Drag chute - As required.
8. Main fuel shut-off valve - CLOSED (guard up).
9. Landing Gear - UP.
If there is insufficient runway remaining to stop after touch down.
10. Generator - battery switch - OFF. (before making contact with the ground.)
11. After aircraft touches down - jettison canopy.
Pull both left and right canopy

handles fully to the rear simultaneously and lift the canopy free from the cockpit.

12. Evacuate aircraft immediately after it stops.

PARTIAL POWERLOSS DURING TAKEOFF

The pilot should check that the throttle is full open. If power loss is still evident, he must make the decision to continue or abort takeoff. If power loss occurs during the takeoff roll proceed as described under Complete Power Failure Before Leaving the Ground. If the power loss occurs after takeoff and the decision is to continue flight, retract the landing gear as soon as possible. The engine fuel control should be switched to emergency since this may correct the difficulty. Flight can be sustained with engine speed as low as 70% RPM. Attempt to make a flameout pattern from the low key point and land as soon as possible. Lower the landing gear when the runway is assured.

NOTE

Do not reduce power until absolutely necessary. You may not be able to regain the previous level of power.

ENGINE FAILURE DURING FLIGHT

In case of an engine failure during flight, there may be only a minimum of time and altitude available to determine a course of action. The following factors should be considered in deciding whether to make a flameout landing, an airstart attempt, or a bailout:

1. An airstart can be readily accomplished providing the cause for the failure has been corrected and the engine RPM is at least 10 to 12%.
2. If engine RPM has been allowed to drop to 7% or lower (due to low air-speed), at least 3000 ft. of altitude will be consumed in increasing the

engine speed to 10 to 12% for an airstart.

3. A safe ejection is doubtful at very low altitude. See "Bailout".
4. A manual bailout decision normally should be made above 5000 ft.
5. A flameout landing pattern normally should not be attempted below 1000 ft.

ENGINE FAILURE ABOVE 45000 FT.

If the engine failure occurred above 45000 ft. the protection of your pressure suit will be necessary. In anticipation of suit inflation it is advisable to tighten the helmet tie-down cables. Place your hand on the seat pack "Press-To-Test" button and if your pressure suit does not inflate at a cabin pressure of 45000 ft., press the button until inflation is obtained. If there is still no action, and it is felt that the oxygen supply may be at fault, pull the emergency oxygen supply, "green apple".

NOTE

The cabin pressure decay rate will vary depending on the effectiveness of cabin sealing. It may be several minutes after engine shutdown before the pressure suit is automatically actuated.

The glide speed that gives the greatest distance for the least loss of altitude is 115 knots IAS, with a clean configuration. If desired the rate of descent can be increased by extending the gear and speed brakes. If necessary a fast descent can be made as described under "Emergency Descent".

WARNING

During a fast descent care must be exercised that the airspeed limita-

tions are not exceeded or structural failure may result. The gust control must be actuated to GUST at 45000 ft. or the speed warning system, if installed, will sound the horn and automatically extend the speed brakes as the speed builds up to approximately 220 knots IAS. The speed warning system will be inoperative if the battery generator switch is off.

The engine windmilling will maintain generator operation for a few minutes. Turn off nonessential electrical items and continue your descent to air start altitude. The battery may be used as necessary after the generator "drops-out".

1. Oxygen regulator "Press-To-Test" as necessary.
2. Throttle OFF as soon as engine failure is recognized.
3. Unnecessary electrical equipment OFF.
4. Establish 115 knot IAS, glide to a suitable landing area.
5. Glide down to 35000 ft. before attempting an airstart.

TURBINE BUCKET FAILURE

If a high altitude flame out is accompanied by moderate engine roughness, it may possibly be caused by failure of a turbine bucket. A normal restart can be made; however, maximum altitude and power will be limited. Exhaust gas temperature should be monitored carefully and flight continued at reduced power. If maximum altitude cruise is resumed a second flameout will probably occur. A landing should be made as soon as possible, although the engine will operate at reduced power for many hours in an emergency situation.

NOTE

Do not confuse this type of failure with engine flameout due to other causes, when engine roughness is not present.

COMPRESSOR BLEED VALVE MALFUNCTION

The present bleed valve configuration is spring loaded to the closed position and malfunctions are uncommon. However, failure of the valve to close at an engine speed of 78 to 82% as power is advanced for take off, is reason to abort any high altitude mission. Failure of the valve to close is indicated by the bleed valve warning light in the cockpit.

NOTE

The bleed valve will normally open at moderate to low altitudes at low engine powers.

If the bleed valve should open above an altitude of 63,000' on a P-37 engine, a flameout is probable. After a restart, flight may be continued at a slightly lower altitude than that at which the trouble occurred. On a P-31 engine, bleed valve opening does not cause a flameout but the reduction of power causes a loss of cruise altitude of approximately 2,000'.

At altitudes of 45,000' to 55,000', failure of the bleed valve to open properly when the power is reduced to idle will result in low power compressor stall. This condition is evidenced by continued "banging" of the engine. This is not considered dangerous, but is very disconcerting. In most cases, the engine must be shut off and a normal restart made at lower altitude. Use of higher power will prevent the condition from developing.

ENGINE VIBRATION

Severe engine vibration usually indicates internal engine failure and continued high

power operation may result in complete failure. When severe engine vibration is encountered, proceed as follows:

1. Slowly adjust the engine speed to a setting which will give minimum vibration.

NOTE

The adjusted engine speed may not eliminate vibration but will reduce its severity and may permit continued use of the engine until a landing can be made.

2. Exhaust gas temperature - MONITOR
Closely watch EGT gage. If temperature rises above the maximum allowable inflight temperature, reduce power and descend to lower altitude. If temperature is still too high, shut off engine. Check for presence of fire in aft section.
3. Ram air switch - ON.
If a fire is suspected, turn the Ram air switch ON to preclude smoke entering the cockpit through the pressurization system. Be prepared for depressurization.
4. LAND AS SOON AS POSSIBLE

NOTE

A form of airplane roughness, similar to that caused by engine vibration is sometimes encountered. This is caused by engine tail pipe misalignment and is easily corrected by ground adjustment.

FLIGHT RELIGHT CHART

P-31 OR P-37 ENGINES

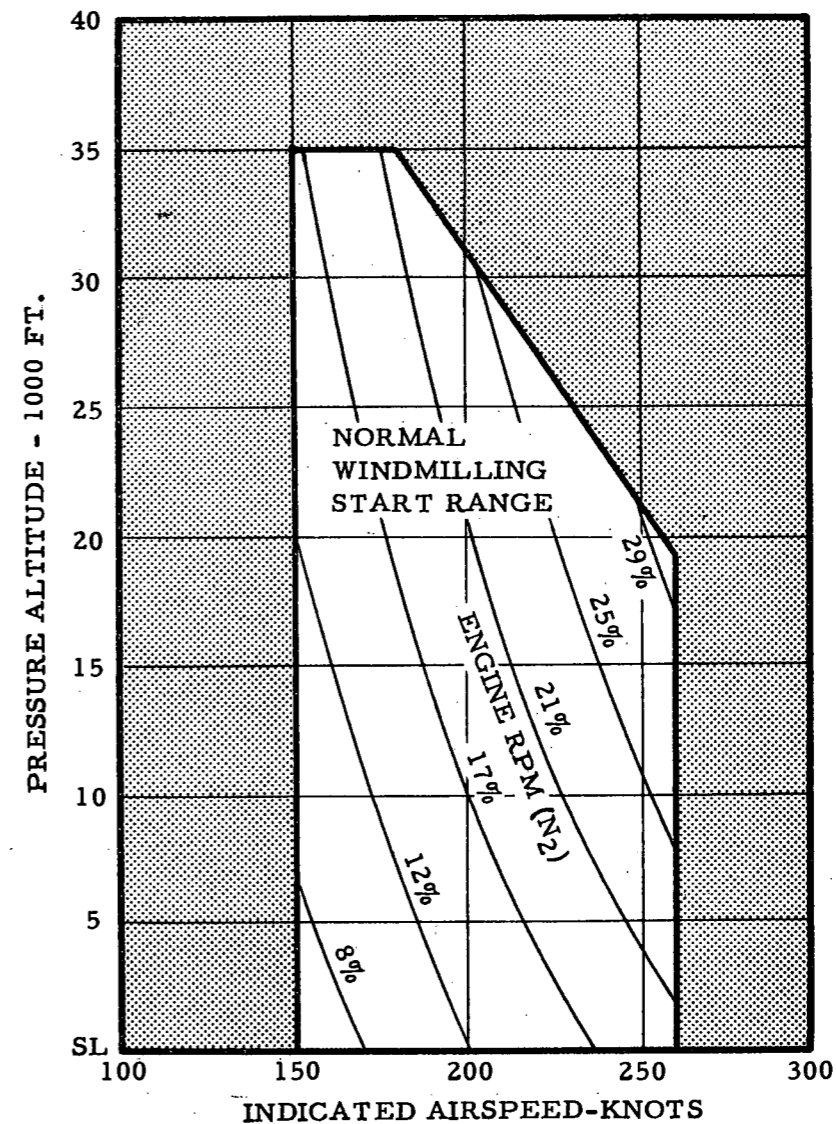

Figure 3-1

AIR START

GENERAL

Before attempting an air start, time and altitude permitting, a trouble check should be made to determine the cause of the flameout.

1. If it was accompanied by an explosion, (other than the "bang-bang" of compressor stall), severe vibration, or fuel vapor in the cockpit, indicating mechanical failure in the engine, exercise caution in attempting an air start.
2. If the fuel low level light is on, the flameout was probably due to fuel starvation and a restart can not be made.
3. If the fuel pressure has dropped to zero, indicating failure of the hydraulic driven fuel boost pump, a restart should be successful and the flight then continued below an altitude of 55000 ft.
4. If compressor stall is the apparent cause of the flameout, a restart should be successful and flight may be continued as desired. The climb back to high altitude may be made if physiologic factors are satisfactory. Avoid the conditions under which the flameout was encountered.

At 35,000 ft. or below, air starts can be made using the normal starting procedures and battery power (see Figure 3-1). The engine will accelerate after a few seconds but there will probably be some chugging on the acceleration. Exhaust gas temperature lags slightly behind the RPM in restarting a cold engine.

AIR START PROCEDURE
(Normal fuel system)

1. Airspeed & RPM - HOLD 150-180 KNOTS AND 15% RPM OR MORE.

2. Generator - battery switch - BAT.
3. Inverter - ON.
This is necessary to determine EGT during start.
4. Throttle - IDLE
5. Ignition - START & HOLD.
Hold in START until engine is running.
6. Generator - battery switch - GEN - BAT.
Place the switch in GEN-BAT position and check generator output.
7. If start does not occur after 30 seconds of ignition - PLACE THROTTLE OFF, DRAIN TAIL-PIPE AND REPEAT 1-6 ABOVE.
8. If start attempt is still unsuccessful - ACCOMPLISH PROCEDURES OUTLINED FOR AIR START PROCEDURE (Emergency fuel system)

AIR START PROCEDURE
(Emergency fuel system)

Air starts on the emergency fuel system are only slightly different from those on the normal fuel system. The throttle must be advanced to compensate for the lower minimum fuel flow setting with the emergency system. The following procedure should be used when air starts on the normal fuel system have been unsuccessful:

1. Throttle - OFF.
2. Airspeed & RPM - HOLD 150-180 KNOTS AND 15% RPM OR MORE.
3. Generator - battery switch - BAT.
4. Inverter - ON.
5. Fuel system selector switch - EMER
Hold down to EMER position for

two seconds and release. Check for amber fuel system EMER light ON.

6. Throttle - 1/4 TO 1/3 OPEN.
7. Ignition - START & HOLD
Hold in START until engine is running.
8. Throttle - ADJUST
Adjust throttle as necessary for adequate acceleration and minimum "chugging".
9. Generator - battery switch - GEN - BAT.
Place switch in GEN-BAT position and check generator output.

WARNING

1. At lower airspeeds, such as speed for maximum glide distance (115 kts), the ignition will occur, but acceleration is slow and a hot start may result. The airspeed should be increased before the start is attempted.
2. In general it is not necessary to drain the tail pipe before the first start attempt; however, if a false start has occurred, the tail pipe should be drained by raising nose of aircraft.
3. If the dead engine glide is carried down to lower altitudes for special reasons, such as to save fuel for landing, the engine windmill speed will slow down to approximately 7% RPM. The engine will not start at this speed. Allowance should be made for approximately a 3000 ft. loss in altitude as speed is increased in order to boost the windmill speed. The engine can then be started at 10 to 12% RPM.

ENGINE FUEL SYSTEM MALFUNCTIONS

ENGINE OVERSPEED

The most serious type of malfunction in the fuel control is runaway engine overspeeding. Corrective action must be taken quickly or complete failure will result. Complete the following procedure:

1. Throttle - OFF.
Shut engine OFF immediately to prevent overspeeding.
2. HEAD FOR NEAREST SUITABLE LANDING FIELD.
3. MAKE NORMAL AIRSTART
4. If overspeed condition persists - SWITCH TO EMERGENCY FUEL SYSTEM WITH THROTTLE IN IDLE.
5. If overspeed condition still persists - THROTTLE OFF AND ATTEMPT AIRSTART ON EMERGENCY FUEL SYSTEM.
6. If overspeed still exists - ATTEMPT FUEL CONTROL REGULATION WITH THROTTLE BETWEEN IDLE AND OFF.
7. If overspeed cannot be controlled - THROTTLE OFF AND GLIDE FOR FLAMEOUT LANDING.
Glide may be extended by starting and stopping engine as necessary.

OFF IDLE STALL

It is possible for a condition to develop during which the engine will not accelerate from idle speed. This is called an off idle stall and is caused by excess fuel being metered for engine acceleration. The symptoms are lack of acceleration and rapidly increasing exhaust gas temperature. If this is encountered, follow these procedures:

1. Throttle - IDLE.
Retard the throttle to idle to reduce

amount of excess fuel.

2. Fuel system selector switch - EMER.
Hold the switch down for 2 seconds in order to change over to the emergency fuel control.
3. Throttle - ADVANCE CAREFULLY
The throttle must be moved carefully since the emergency fuel control has no acceleration limiter.
4. Fuel system selector switch - NORMAL.
If desired, the normal fuel control can be selected after reaching 70% RPM.

to allow engine blowout at high altitude. Idle RPM at low altitude may be low enough to cause slow acceleration time.

Changeover

The changeover in either direction between normal and emergency systems is easily made. The throttle should be retarded to near idle and the fuel system selector switch moved to the desired position. Throttle position for a given RPM will not be the same on emergency as it was on the normal system. Above 40,000 ft. the changeover becomes marginal and engine flameout may result.

FLAMEOUT LANDING PROCEDURE

DESCENT WITH ENGINE INOPERATIVE

When a flameout occurs proceed to the nearest suitable airfield. The airplane has a very good glide ratio of 23:1. Therefore, from 70,000 ft. the airplane will glide 250 nautical miles as shown in Figure 3-2. Maintain 115 knots IAS for the best glide ratio. (clean configuration).

Airstarts should be attempted, if engine is not damaged, down to approximately 5000 ft above the terrain. If an airport landing is to be made on a field with adequate runway, the landing gear should be down and locked at sufficient altitude, if practicable, to enable you to concentrate on flameout pattern work.

FLAMEOUT LANDING PATTERN

The recommended traffic pattern for a flameout landing is the 360° overhead approach as shown in Fig. 3-3. The point over the touchdown end of the runway is defined as the high key point. The downwind point opposite the end of the runway is the low key point and the base leg is the 270° point. It is important to adjust the high and low key so that proper threshold speed of 75 knots is reached for zero fuel. Add two knots for every hundred gallons of fuel. The

EMERGENCY FUEL CONTROL

General

This control is used in the event of failure of the normal fuel control unit.

WARNING

While operating on the emergency fuel control, throttle movements must be carefully made to prevent engine overspeeding or overtemperature operation with resultant engine failure.

Climb

During climb, especially above 30,000 ft., the throttle must be gradually retarded to keep exhaust gas temperature within allowable limits.

Descent

During descent the throttle must be adjusted to give approximately the same engine speeds as are obtained on the normal system. Power changes must be carefully made, particularly at high altitude. The minimum fuel flow on the emergency system is low enough

DEAD ENGINE GLIDE DISTANCE

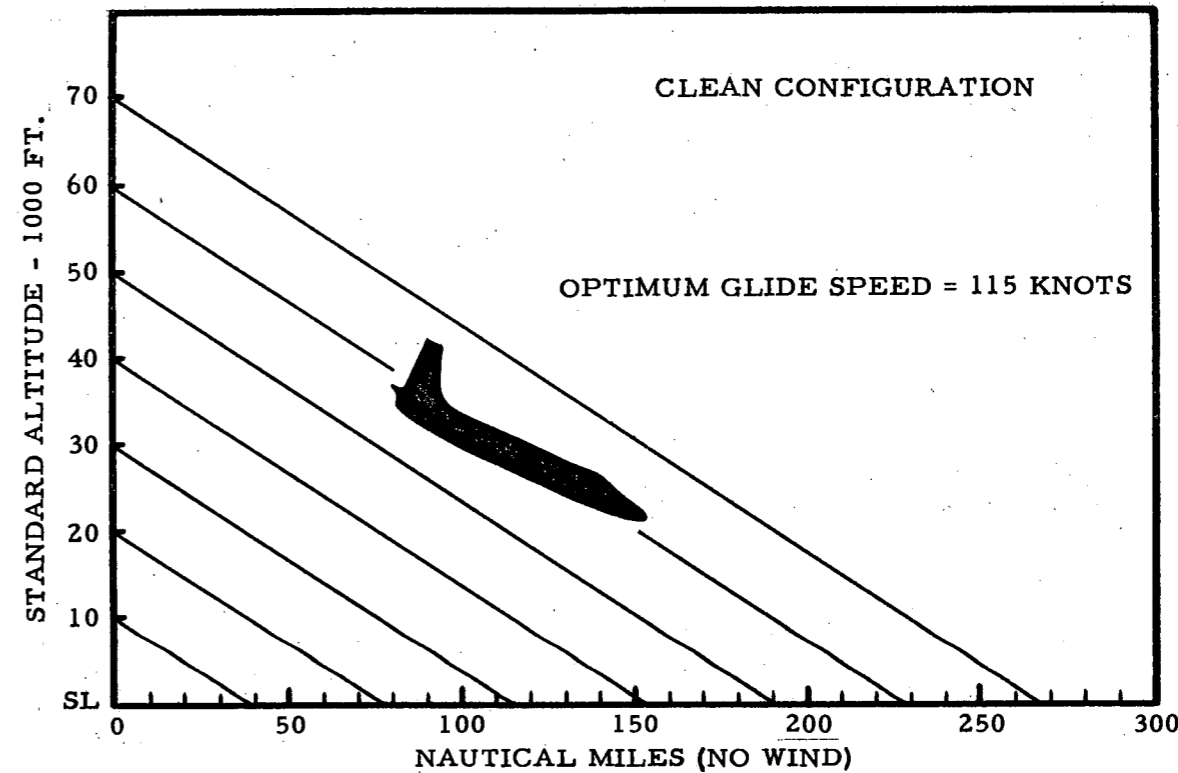

Figure 3-2

planned touchdown point should be one-fifth of the way down the runway. The airplane will float less than normal with the engine dead. The engine driven hydraulic pump may furnish sufficient hydraulic pressure to actuate the wing flaps with a windmilling engine. At windmilling RPM the wing flaps will be slow. DC power is necessary for flap extension.

HIGH KEY POINT:

1. Altitude - 1500 FEET ABOVE THE GROUND.
2. Airspeed - THRESHOLD PLUS 30 KNOTS.
3. Landing gear - DOWN.
4. Wing flaps - UP.
5. Speed brakes - RETRACTED.

LOW KEY POINT:

1. Altitude - 750 FEET ABOVE THE GROUND.
2. Airspeed - THRESHOLD PLUS 20 KNOTS.
3. Landing gear - DOWN.
4. Wing flaps - AS REQUIRED.
5. Speed brakes - RETRACTED.

TURN TO BASE LEG:

1. Altitude - 500 FEET ABOVE THE GROUND.
2. Landing gear - DOWN.
3. Wing flaps - AS REQUIRED.
4. Speed brakes - RETRACTED.
5. Airspeed - THRESHOLD PLUS 10 KNOTS AFTER TURN.

FINAL APPROACH:

1. Airspeed - REDUCE TO THRESHOLD PLUS 5 KNOTS.
2. Wing flaps - FULL DOWN IF REQUIRED.
3. Speed brakes - OUT WHEN RUNWAY IS ASSURED.
4. Airspeed - REDUCED TO THRESHOLD. Airspeed should still be slightly above threshold speed when over the end of the runway since touchdown point is normally farther down.
5. Drag chute - DEPLOY.

CAUTION

The drag chute may not deploy since no jet stream is present.

Flameout landings with any drag configuration can be made with the high key point as low as 1000 ft. above the ground, provided a tighter pattern is used. It is also practical to enter the pattern at one of the lower key points, if sufficient altitude is not available for a complete 360° pattern.

SIMULATED FLAMEOUT

To become proficient in glides, approaches and landings with a dead engine it is recommended that the following procedures be practiced:

Approach

In gliding from altitude to the airfield, the following configuration will simulate a dead engine, clean airplane:

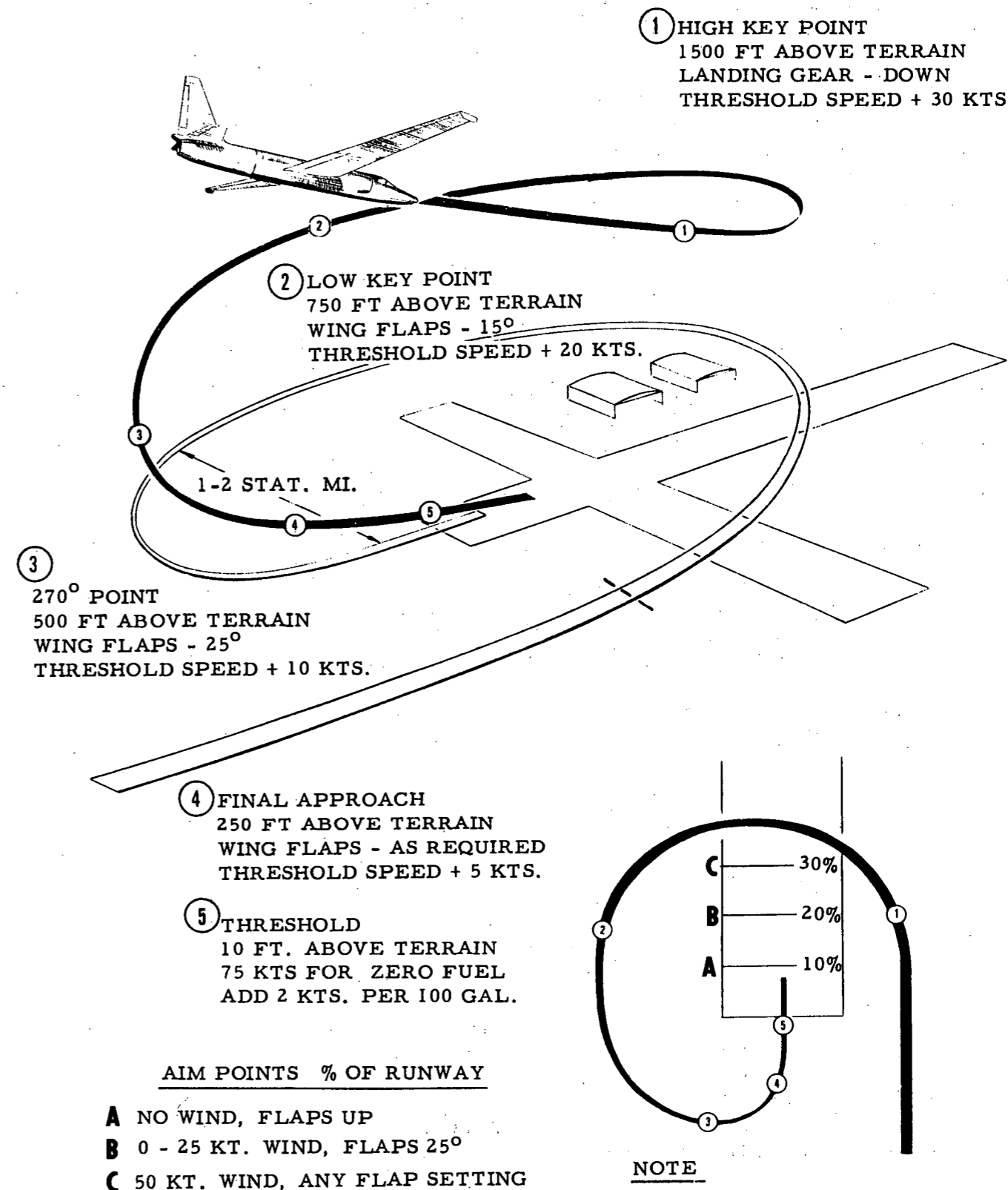

TYPICAL FLAME-OUT LANDING PATTERN

FIG. 3-3
SECRET

1. Glide at 115 knots IAS.
2. Speed brakes extended.
3. Landing gear retracted.
4. Engine at 65% RPM.

are the same as for a flaps extended landing. This speed will still give adequate margin over the stall for this emergency condition.

CAUTION

Don't allow the airspeed to fall very much below the proper threshold speed during approach. Touchdown will be made at a slightly higher speed than normal.

If desired this condition can also be simulated with landing gear extended and 70% RPM.

Landing

To simulate a dead engine landing pattern with landing gear extended and speed brakes retracted, the following configuration should be used:

For simulation of a flaps up landing.

1. Wing flaps up.
2. Speed brakes extended.
3. Landing gear extended.
4. Engine at idle RPM.

For simulation of a 30° flap landing.

1. Wing flaps down 35°.
2. Speed brakes extended.
3. Landing gear extended.
4. Engine at idle RPM.

On short runways, the drag chute is of great advantage for this type of landing. However, it is not necessary if other variables are properly controlled. Another aid to shorten the float and ground roll is to shut off the engine at the threshold. The following procedures should be used:

1. Speed brakes extended. (If available)
2. Threshold altitude properly controlled.
3. Threshold speed properly controlled.
4. Deploy drag chute.
5. Engine power - Cut off when landing is assured.

LANDING WITH LANDING GEAR UNSAFE

These instructions apply only to landing on prepared hard surfaces. If either landing gear indicates an unsafe condition when extended for landing make a low pass by the control tower and ascertain if the gears appear to be extended. Whenever either of the gear cannot be extended with the normal hydraulic system, the emergency system will be used in an attempt to lower the remaining gear. (Refer to landing gear emergency extension, this section.) A gear down landing should be accomplished whenever the main gear can be extended and locked in the down position. The techniques for main gear

LANDING EMERGENCIES

LANDING WITH WING FLAPS RETRACTED

If the wing flaps cannot be extended a satisfactory landing can be made if caution is exercised. In the flaps up configuration the drag is low and the airplane will float further. In order to overcome this characteristic the proper threshold speed and altitude must be observed. If the approach is too high or too fast, go around and make proper corrections on the next approach. Threshold conditions

landings and a wheels up landings on prepared surfaces differ considerably and are discussed separately in the following paragraphs.

Both Gears Down-Show Unsafe

If both main and tail gear appear to be in the down position, but one or both indicates an unsafe condition, make a normal landing. The engine must be left running in order to maintain hydraulic pressure until ground safety pins are installed by the maintenance crew.

Main Gear Fully Extended

Make a normal pattern using speed brakes and the desired amount of flaps if normal hydraulic pressure is available. Allow aircraft to touch main gear first.

WARNING

Do not stall the aircraft. This would probably result in hitting the tail first and cause considerably more damage.

When initial contact is made, move the control column forward and hold. The nose-low, tail-high altitude gives effective directional control. As speed decreases, the tail will slowly come down. After aircraft has landed, shut the engine OFF, flaps FULL DOWN, main fuel shut off to the OFF position, battery-generator OFF, deploy drag chute and use the brakes as much as possible without sliding the tires.

Wheels Up Landing

Fly aircraft on ground at slightly higher speed than for normal touchdown so that the aircraft contacts the ground in a level attitude. To help attain level attitude, utilize full flaps during approach to landing. After aircraft has landed, shut engine off, main fuel shut-off to the OFF position, battery-generator

OFF.

LANDING ON UNPREPARED SURFACE

Because of the low landing speeds of the U-2, safe landing can be made on any reasonably smooth unprepared surface. However, because of structural limitations, a landing on extremely rough terrain or on terrain with many obstacles is considered hazardous and bailout is normally preferable. For an emergency landing on an unprepared surface, the following procedures will be used:

1. Ejection safety pin - INSTALLED.
This is difficult to accomplish in flight and may be omitted if necessary.
2. Face plate - REMOVED AND STOWED.
3. Oxygen - OFF.
Turn both valves OFF.
4. Parachute and suit connections - UNFASTEN.
5. Landing gear - DOWN.
6. Speed brakes - AS REQUIRED.
7. Wing flaps - AS REQUIRED.
8. Make a normal approach.
9. Throttle - OFF WHEN FIELD IS ASSURED.
10. Main fuel shut-off switch - CLOSED.
11. Battery switch - OFF.
12. Evacuate aircraft as soon as possible after landing.

CAUTION

If it is desired to jettison the canopy prior to a crash landing, it must be accomplished at high enough altitude to allow for bailout in the event structural damage is caused by the canopy.

DITCHING PROCEDURES

In general, bailout is preferable to ditching if the choice exists. If actual conditions preclude a safe bailout or an immediate rescue is more probable with ditching, the following procedure will be used:

1. Transmit MAYDAY message.
Actuate the ARA-26 keyer, if available.
2. Canopy - JETTISON.
3. Suit capstan connection - DISCONNECT.
4. Parachute - UNBUCKLE.
5. Shoulder harness - LOCKED.
6. Gear, speed brakes and flaps - RETRACTED.
7. Throttle - OFF.
8. Just before touchdown, all switches - OFF.

Plan touchdown on the down side of a wave crest, parallel to the crest pattern. Touchdown slightly faster than normal - do not stall in. Wait until aircraft has come to a complete stop, then leave as soon as possible.

EMERGENCY DESCENT

MAXIMUM RATE MANUAL DESCENT

If it becomes necessary to reach lower altitudes in the minimum time, the fast descent

can be made slightly faster by remaining in a 60° banked spiral and increasing the maximum speed to 260 knots IAS. The only disadvantage is an increase in general roughness. Shutting the engine down will increase the rate of descent but may result in windshield and canopy frosting.

WARNING

This maneuver will require a constant 2G acceleration and doesn't leave much margin for recovery from an overspeed condition.

The following procedure should be followed:

1. Landing gear - DOWN.
2. Gust control - FAIRED.
3. Speed brakes - EXTEND.
4. Throttle - REDUCE TO MINIMUM PR.
5. Descent - 2 "G", 60 DEGREE SPIRAL.
6. Airspeed - NEEDLES TOGETHER.
7. Gust control - GUST AT 45,000'.

AUTOPILOT CONTROLLED DESCENT

The autopilot can be relied on to control the descent if desired, by use of the Mach sensor. This would be advisable if the pilot felt he might lose consciousness or be incapacitated in some way. There are several actions which should be completed if at all possible; however, the aircraft will descend if only the landing gear is extended and the power lever is retarded, assuming that the autopilot and Mach sensor are already engaged. The following procedure should be followed, in order:

1. Pull the green apple. (If there is any question of oxygen supply.)
2. Extend the landing gear.

3. Place the gust control in GUST position. Note that this automatically disengages the autopilot.
4. Re-engage the autopilot and engage the Mach sensor at a speed approximately 10 to 20 knots below the warning needle.
5. Extend the speed brakes.
6. Retard the throttle and maintain minimum pressure ratio.

3. Improper installation of, or defective warning light circuit.

Illumination of the steady red fire warning light is generally caused by:

1. Fire (in the forward engine section).
2. Hot spots in the combustion chamber.
3. Defective warning light circuit.

GROUND FIRE

In the event of visible or indicated fire on the ground:

1. Throttle - OFF.
2. Fuel shutoff valve - CLOSED.
3. Generator-battery switch - OFF.
4. Oxygen valves - OFF.
5. Evacuate aircraft as soon as possible.

WARNING

The airplane will reach airspeed placard limitations as it descends. If the gust control is FAIRED, the limitation will be reached fairly early. This will be a critical situation and will require action by the pilot when the speed warning system is actuated. Therefore, it is very important to get the gust control in GUST position before descent since more structural margin exists for this configuration.

This type of descent can also be used with a dead engine if absolutely necessary. This will require heavy usage of the battery, and all nonessential electrical loads should be turned off if possible.

FIRE

There is no fire extinguishing system installed in the aircraft.

PROBABLE CAUSES OF FIRE OR OVERHEAT INDICATION

Illumination of the flashing red warning light is generally caused by the following:

1. Fire (in the aft section).
2. A leaky tailpipe, tail cone or connections.

ILLUMINATED FIRE OR OVERHEAT WARNING LIGHTS (DURING TAKEOFF)

If either the overheat or fire warning light illuminates and stays on during the takeoff roll and there is sufficient runway left to abort the takeoff, proceed as follows:

1. Throttle - OFF.
2. Main fuel shutoff valve - CLOSED.
3. Stop as soon as possible.

ILLUMINATED FIRE OR OVERHEAT WARNING LIGHTS (AFTER TAKEOFF OR DURING FLIGHT)

The high flash point of the fuel combined with the lack of oxygen at the operating altitudes of this aircraft greatly reduce the probability of fire at high altitude. However, if the overheat or fire warning light illuminates

when airborne or too late to abort the takeoff, proceed as follows:

1. Throttle - Minimum practical power.
2. Signs of fire - CHECK.

Check for evidence of:

- a. Fluctuating fuel pressure and RPM.
 - b. Loss of engine RPM.
 - c. Smoke entering cockpit through pressurization ducts.
 - d. Smoke trail behind aircraft.
3. If fire is evident, throttle - OFF.
 4. Main fuel shutoff valve - OFF.
 5. Make decision to bailout or execute emergency "deadstick" landing.
 6. If no indication of fire exists except warning light, continue at reduced power setting and land as soon as possible.

COCKPIT FOG OR SMOKE ELIMINATION

COCKPIT FOG

Under certain atmospheric conditions, the cabin air cooler will create a vapor which resembles smoke. This can be eliminated by moving the cabin temp rheostat to a warmer air position. Prior to takeoff, make sure air entering cockpit is slightly warm.

COCKPIT SMOKE

If smoke is noticed in the cockpit during takeoff, it is probably caused by oil that has accumulated in the pressurization system. This smoke is generally light gray or white and is no cause for alarm. Some difficulty has been experienced with smoke in the cockpit caused by engine oil entering the air conditioning system while in flight. This also

deposits oil on the windshield through the defroster and general air circulation. The smoke and oil usually occur at higher altitudes with the P-37 engine. If smoke does occur in cockpit:

1. Defroster - OFF.

This will reduce the amount of oil deposited on the windshield.
2. Temperature control - COLD.

This will reduce the quantity of smoke.
3. Generator-battery - OFF.

Turn the generator-battery switch to the OFF position until it is determined that the smoke is not caused by an electrical short.

If smoke is so bad that the mission cannot be continued:

4. Throttle - REDUCE POWER AND START DESCENT.

The smoke may clear up at lower altitudes and lower engine power.
5. Ram air - ON IF SMOKE PERSISTS.

Be prepared for cockpit depressurization.
6. Throttle - OFF IF SMOKE CONDITION REMAINS HAZARDOUS.

If the condition persists and is too bad to continue the descent and landing, place the throttle OFF and switch main fuel shutoff to OFF.
7. Canopy - JETTISON IF NECESSARY.

As a last resort, open or jettison the canopy to obtain visibility. Be prepared for any necessary action due to aircraft damage if the canopy is jettisoned.

CAUTION

Anytime smoke is present in cockpit, insure that face plate is worn and oxygen is on. Leave face plate on if canopy jettison is contemplated.

EMERGENCY CANOPY REMOVAL

There is a normal canopy lock and release handle located on the right cockpit sill and an emergency canopy release (red) on the left cockpit sill. The left release dumps cockpit pressurization by venting the canopy seal pressure and also disengages the left canopy hinge.

CANOPY REMOVAL ON GROUND

1. Grasp both handles with palms down and pull back simultaneously.
2. If insufficient airspeed exists to carry the canopy away, remove the canopy from aircraft by pushing up and to the left.

WARNING

Insure that the left handle has completed full travel to unlock the hinge mechanism. This handle requires considerably more force to actuate than the right handle.

CANOPY REMOVAL WHILE AIRBORNE

Follow the same procedure; however, it is advisable to retain face plate to prevent debris from striking the face. Duck head after releasing canopy to insure that no portion of the canopy strikes the pilot. Retain face plate for wind protection after canopy removal.

EXTERNAL CANOPY OPENING

Depress the spring-loaded retaining button at the base of the canopy locking lever on the right side of the aircraft below the canopy rail. The canopy locking lever will spring free from its flush mounted position. Rotate the lever in a clockwise direction to release canopy lock. Lift canopy from rail and open toward left side of aircraft.

BAILOUT

A very high altitude bailout should be avoided except in an extreme emergency. A bad cockpit fire or uncontrollable maneuvers which could cause serious bodily injury are probably the only situations that would cause an immediate bailout at high altitude. With aerodynamic or structural trouble, the pilot may be able to remain in the cockpit until reaching a lower altitude.

NOTE

Static ejection tests indicate that ejection can be safely made through the canopy. Therefore, ejection through the canopy is the primary bailout method in the U-2.

PRIOR TO BAILOUT

If time permits, the following items should be accomplished prior to bailout:

1. Aircraft speed - REDUCED IF EXCESSIVE.
2. Emergency oxygen supply - PULL GREEN APPLE.
3. Helmet tiedown - TIGHTENED.
4. Emergency face heat wires - DISCONNECT.

If this system is connected, remove the snaps on the face plate.

5. Seat pack disconnect - DISCONNECT.

This is only necessary on those airplanes with disconnects located on the left console.

6. Radio call - TRANSMIT "MAYDAY".

7. Destruct system - ARMANDACTUATE.

Generator-battery switch must be in the BAT position to operate destruct system. (This should be the last step before leaving the airplane for bailout without an ejection seat.)

BAILOUT WITH EJECTION SEAT

1. Proper body position - ASSUME.

Normal ejection position is taken with feet in stirrups, head back and hands on "D" ring between knees.

2. Seat ejection "D" ring - PULL AND HOLD.

Raise hands, leaving elbows in lap.

NOTE

Ejection is not started until initiator pin is pulled at end of "D" ring travel. The "D" ring should be kept in hands during ejection to restrain arms.

BAILOUT WITH NON-EJECTION SEAT

1. Seat - LOWERED.

2. Seat pack quick disconnect - DISCONNECTED.

(On those airplanes with left console disconnect.)

NOTE

On airplanes with right hand quick disconnect, the emergency oxygen supply is activated and disconnect separated automatically upon standing up. The green apple may be pulled manually to reduce the load required to separate the disconnect.

3. Canopy - JETTISON WITH HEAD LOW.

Pull left and right handles simultaneously.

WARNING

The left handle usually pulls harder than the right. To assure the canopy leaving the airplane, both handles must be pulled all the way back.

4. Automatic parachute opening device - PULL IF AT ALTITUDE.

5. Seat belt and harness - DISCONNECTED.

6. Bailout - DIVE OVER THE RIGHT SIDE.

EJECTION ALTITUDES

The use of the automatic seat belt and the low altitude escape lanyard make possible successful ejections at very low altitude. The automatic seat belt is an integral part of the ejection seat system and is operated by gas pressure from an initiator after a two second delay. The automatic or aneroid controlled parachute has a lanyard which is attached to the seat belt. After ejection, this lanyard is pulled by the separation of the pilot from the seat. This actuates the parachute aneroid which will open the parachute at a preset altitude or after 2 seconds if below the preset altitude.

The low altitude escape lanyard is connected

directly to the parachute "D" ring. Therefore, separation from the seat will pull the parachute "D" ring. This connection must be made by the pilot at low altitudes only, since it would be disastrous at high altitudes. The use of this low altitude escape lanyard, which pulls the "D" ring directly, eliminates the two second aneroid timer delay and insures prompt release of the parachute upon separation from the seat. This system of two second seat belt opening and immediate parachute deployment will make possible a successful bailout at very low altitude. However, since aircraft forward speed is also a factor, no definite minimum ejection altitude can be given. It is very doubtful if a bailout below 500 feet would be successful. Above 500 feet the chances improve rapidly.

OXYGEN SYSTEM MALFUNCTION

EXCESSIVE OXYGEN CONSUMPTION

A running check should be maintained on oxygen system pressure during any high altitude mission. When the oxygen plot falls below the pre-plotted average consumption curve, the oxygen pressure will be checked every 15 minutes. After several plots have been made, if the oxygen curve is dropping below and diverging from the pre-plotted consumption curve, the mission will be discontinued.

Descend to a cabin altitude of 10,000 feet as soon as possible and proceed directly to home station or to an alternate, depending on fuel remaining. In no case should the flight be continued at altitude when the oxygen pressure has reached 500 psi or less.

NOTE

If at high altitude with no ship oxygen, pull the "green apple" and make a fast descent to a 10,000 foot cabin altitude.

WARNING

If the pilot is unable to regain an oxygen supply, he will have to open the face plate in flight. Use the autopilot emergency descent and exercise extreme caution to avoid possible flameout and accompanying loss of pressurization.

SUSPECTED OXYGEN DIFFICULTY

If the pilot suspects oxygen difficulty due to symptoms of hypoxia or by noting the helmet bladder collapsing, he should take the following action:

1. Actuate the emergency oxygen supply by pulling the "green apple".
2. Actuate the "Press-to-Test" button on the seat pack.
3. Inspect (by aid of a mirror) the "T" fittings on the suit and inspect the seat pack quick disconnect for proper fit and engagement.
4. Check the face plate and locking bar for security.
5. Make emergency descent on autopilot.

NOTE

1. If at anytime during flight the pilot finds it necessary to open the face plate, an immediate descent will be made to an aircraft altitude of 45,000 feet prior to opening the face plate. The face plate will then be checked for proper seating by using the mirrors in the aircraft and will also be subjected to "Press-to-Test" pressure. If these checks are satisfactory, a re-ascent may be made if necessary.
2. In case "bends" are encountered, descend until the symptoms disappear.

AIRCRAFT SYSTEM DIFFICULTY

See SECTION IV for information relative to difficulty with the oxygen system pressure reducers.

HYDRAULIC SYSTEM EMERGENCY OPERATION

COMPLETE HYDRAULIC PRESSURE LOSS

There is no action which can be taken to restore a hydraulic system after failure; however, its effects can be minimized. The hydraulic system is of extreme importance to high altitude missions since failure of the hydraulic driven fuel boost pump will cause flameout above 55,000 feet. If the hydraulic pressure starts falling rapidly, a descent should be made to 55,000 feet to guard against engine flameout.

If the hydraulic pressure gage indicates zero, or very low pressure, operate the speed brakes to determine if the gage is faulty. In case the pressure is actually lost, the wing flaps and speed brakes will be inoperable in addition to the fuel boost pump. The landing gear can be extended by use of emergency procedures. The landing will be made as outlined under "Landing With Wing Flaps Retracted".

WARNING

Since the wing flaps cannot be moved to the GUST position, the placard speed for FAIRED must be observed.

PARTIAL HYDRAULIC PRESSURE LOSS

A case of partial pressure loss may be due to pump compensator trouble or to an internal leak in the system. All services will operate but at reduced speed. If the pressure is too low, the landing gear may not fully retract.

LANDING GEAR EMERGENCY EXTENSION

The emergency landing gear extension system is a manual free fall system. Neither electrical power nor hydraulic pressure is required to operate this system.

1. Gear handle - DOWN.
2. Uplock release - PULL.
3. Gear down and locked indication - CHECKED.

(In case of an electrical failure, no indication is available.)
4. Airspeed - INCREASE IF NECESSARY TO ASSIST IN LOCKING THE GEAR.

Do not exceed limiting airspeed for existing configuration and condition.

AIRCRAFT FUEL SYSTEM MALFUNCTION

FUEL BOOST PUMP FAILURE

Failure of the fuel boost pump or its hydraulic drive motor is indicated on the fuel pressure gage in the cockpit. When operating above 55,000 feet, this will probably result in a flameout. In this event, descend to 35,000 feet and make a normal restart. The flight can be continued below approximately 55,000 feet.

FUEL CROSS TRANSFER PUMP FAILURE

If wing heaviness due to uneven fuel flow cannot be corrected by actuation of the cross transfer pump switch, another method may be used. The wing heaviness can usually be corrected by flying in a very slight continuous skid with the heavy wing high.

FUEL COUNTER FAILURE

A fuel totalizing system failure may be evidenced by the stopping of the fuel counter or

by erratic movement of the counter. In this event, a knowledge of fuel flow versus time will assist in determining the approximate fuel remaining. Extend the previous fuel curve to intersect present time and determine approximate fuel remaining. Plan the landing with ample estimated reserve.

FUEL LOW LEVEL INDICATION IN LEVEL FLIGHT AT ALTITUDE

Since there is no fuel quantity gage in the airplane, the fuel low level warning light is very important. When the light comes on during normal level flight, it must be taken as an indication that only 40 gallons of fuel remain in the aircraft to complete the flight. The engine should not be shut down immediately. If landing field is not within gliding range, continue flight at altitude until field is assured. The following criteria can be used as a guide to action.

Field Within 100 NM

When suitable landing field is within 100 NM: (Predicted on a minimum of 20 gallon reserve over field)

1. Declare emergency.
2. Continue flight at altitude to 50 NM from landing area.
3. When within 50 NM, make a "FAST DESCENT" to field.
4. Land from flameout pattern.

Field Within 200 NM

When suitable landing field is within 200 NM: (Predicted on a minimum of 20 gallon reserve over field)

1. Declare emergency.
2. Continue flight at altitude to within 150 NM.

3. When within 150 NM, make a "FAST DESCENT" to 50,000 feet.
4. Shut down engine at 50,000 feet (Glide 115K).
5. Start engine when over the field.
6. Land from flameout pattern.

Field Within 300 NM

When a suitable landing area is within 300 NM:

1. Declare emergency.
2. Continue flight at altitude to 200 NM from landing area.
3. Shut down engine (Glide 115K).
4. Restart engine when over the field.
5. Land from flameout pattern.

Field Within 400 NM

When a suitable landing field is within 400 NM:

1. Declare emergency.
2. Continue flight at altitude or climb to maximum altitude until fuel is exhausted.
3. Establish maximum range glide speed.
4. Make "DEADSTICK" landing.

FUEL LOW LEVEL INDICATION DURING DESCENT

During descent, the low level light may come on prematurely. That is, it may come on even though the fuel counter still indicates considerable fuel on board. This could be an indication that the fuel transfer rate has only momentarily fallen behind the engine fuel consumption allowing the level in the sump tank to drop a few gallons.

More Than 100 Gallons

With more than 100 gallons on fuel counter:

1. Assume level flight.
2. Maintain level flight until a maximum of 10 gallons of fuel have passed through fuel counter in an attempt to refill sump tank.
3. If sump tank refills, CONTINUE DESCENT.
4. If sump tank doesn't refill, DECLARE AN EMERGENCY.
5. Land immediately from flameout pattern.

Less Than 100 Gallons

With less than 100 gallons on fuel counter:

1. Declare an emergency.
2. Continue descent.
3. Land immediately from flameout pattern.

SUMP OVERFLOW INDICATION

This light should normally be on only as an indication that the sump tank has been serviced. It should go out before takeoff or as soon as the engine has used 6 to 8 gallons of fuel. If the light comes on in flight, it indicates that the fuel level in the sump tank is higher than normal. This may be due to fuel entering the sump tank by way of the wing tank vent lines or it may be due to leakage through the fuel level control valves in the sump tank. The illumination of this light is not considered a serious condition since the chances of fuel being forced overboard through the sump tank fuel vent are remote due to its high location on the aircraft vertical fin. However, if it comes on, the mission should be discontinued since it does indicate that the fuel system is not operating normally. Corrective measures should be

taken by maintenance personnel.

NOTE

In those aircraft which do not have the dual vent line modification, it is not unusual for the light to come on shortly after the beginning of the cruise climb. It should go out within one hour. If it does not go out or if it comes on later in the flight, discontinue the mission.

ELECTRICAL SYSTEM MALFUNCTION

D-C SYSTEM

High Loadmeter Reading

The maximum design generator output corresponds to a loadmeter reading of 0.4. If the loadmeter shows a continuous reading above approximately 0.2, proceed as follows:

NOTE

There is some variation in normal loadmeter reading due to differences in equipment carried.

Check all electrically operated equipment such as radios, light switches, etc, by turning them OFF one at a time to determine whether any of these units is the cause of the high loadmeter reading. If one of these units is the cause of the high loadmeter reading and is not vital to the completion of the mission, turn it off. If it is vital, land as soon as possible, operating without it unless it is necessary to the completion of the landing.

Zero Loadmeter Reading

If the loadmeter indicates zero, proceed as follows:

Operate an electrical device, such as the

radio transmitter, to ascertain if the gage is indicating an erroneous low reading. The loadmeter normally increases when an electrical device is placed in operation. Press-to-test the GENERATOR OUT light to insure that the loadmeter indication is not caused by a failed generator. If the loadmeter fails to increase, it indicates loadmeter is inoperative. This malfunction cannot be corrected while airborne. Closely monitor electrical equipment during remainder of flight.

NOTE

The loadmeter should be checked immediately after takeoff and approximately every 15 minutes during flight.

Generator Failure

Failure of the generator will be evidenced in the following ways:

1. Generator out light glowing.
2. Loadmeter indicating zero.

In case of generator failure, the battery-generator switch should be moved to the BAT position. All electrical loads not absolutely needed should be turned off. Examples of the loads with large power requirements are - all radios, A-C inverter, aileron shifter, trim tabs, camera equipment, etc.

Flight can be continued in case of generator failure as long as battery power remains for indispensable items such as face plate heat. However, it should be realized that depletion of the battery will make all electrical items inoperable.

All A-C powered instruments, including flight instruments, will be available in case of generator failure. However, the inverter should be used sparingly since it is a heavy drain.

Flight should be terminated as soon as possible.

Complete Electrical Failure

Complete electrical failure would be evidenced by failure of all electrical devices to operate. This could be caused by generator failure followed by complete battery depletion or some other factor. The important items to remember are:

1. Face plate heat will not be available. This will probably make a descent necessary since vision will eventually become obscured. High cabin temperature will help to keep the face plate clear.
2. Flight can be continued without electrical power and all fuel will feed. The fuel counter will be inoperative and fuel quantity remaining must be estimated.
3. All electrical instruments will fail with the pointers in operating range and the landing gear indicators will show barber pole.
4. The landing gear can be extended with emergency release.
5. Trim tabs will remain as set prior to electrical failure.
6. The air driven turn and bank indicator will still be operable.
7. An air start cannot be accomplished.

If possible, descend to 45,000 feet to decrease the likelihood of a flameout. The flight should be terminated as soon as possible.

A-C SYSTEM

Inverter Failure

Inverter failure is indicated by glowing of the INVERTER OUT warning light. There is no alternate source of alternating current. Flight will be severely handicapped by loss of the autopilot, remote compass, ADF, attitude indicator, and most of the engine

instruments, including pressure ratio and exhaust gas temp. Loss of PR and EGT indications will make advisable a descent to 60,000 feet to prevent engine overtemp or min PR flameout. At 60,000 feet, 88% RPM may be maintained without danger. Flight should be terminated as soon as possible.

Alternator Failure

Failure of the engine driven alternator is evidenced by glowing of the AC ALTERNATOR OUT warning light. Normal flight will not be affected. Turn the switch to the OFF position.

*FM-6
see Tech Data Change*

ENGINE OIL SYSTEM MALFUNCTION

The normal oil pressure operating range is 40 to 50 psi. If the pressure falls below 40 psi or exceeds 55 psi, the mission should be discontinued and the oil pressure carefully monitored. If the pressure falls below 35 psi, an immediate landing should be made if operational conditions permit. The engine should be operated at the lowest practical RPM since continued operation with an oil pressure below 35 psi may result in eventual engine failure.

TRIM TAB MALFUNCTION

MANUAL FLIGHT

A faulty trim switch may cause the trim tab motor to move the tab beyond the desired position and eventually to the maximum limit of travel. Manually returning the trim switch to neutral may not stop this travel. In this event, immediately operate the trim power cutoff switch to OFF. The amount of control force necessary to overcome runaway trim effect will materially increase with high air speeds.

AUTOPILOT FLIGHT

Should the aircraft exhibit pitching tendencies, or if an out of trim indication is observed on

the pitch trim indicator, depress the auto-pilot disconnect. Be alert for high control forces. Retrim aircraft with normal trim. Place trim power cutoff switch "OFF" and re-engage autopilot. Turn off autopilot every thirty minutes and retrim on normal system as required.

GUST CONTROL MALFUNCTIONS

There are several types of malfunctions of the gust control. Since the gust control is so important to the structural capabilities of the airplane, the pilot must always be positive that both wing flaps and ailerons have operated properly. There are several indications to show whether these surfaces are in GUST or FAIRED position as follows:

1. The gust control lights.
These lights are illuminated for GUST position.
2. The wing flap position indicator.
The indicator shows minus 4° for GUST position.
3. Change in pitch trim.
GUST position gives a nose up change.
4. Amount of aileron travel.
Wheel travel is reduced and forces are lighter in GUST.

All of these indications should be observed before exceeding the gust control FAIRED limitations. If either wing flaps or ailerons malfunction, check the WING FLAP AND AILERON SHIFT circuit breakers.

WING FLAPS CONTINUE DOWN

In the event of inadvertent wing flap lowering while returning to FAIRED from GUST, return the gust control switch to GUST. A mission may be flown in GUST with only a 1.5% loss in range. Normal landing can be made.

SECRET

AILERON ONLY IN GUST

In the event the wing flaps will not move to the GUST position:

1. Airspeed - FAIRED LIMITATIONS.

Ailerons only in GUST will give wing bending alleviation.

2. Gust control - FAIRED IF TURBULENCE IS NOT PRESENT.

If ailerons won't return to FAIRED, extra care should be taken to have the fuel load balanced for landing. If necessary, flight can be continued until all wing fuel has been used. Aileron control will be restricted.

WING FLAPS ONLY IN GUST

In the event the ailerons will not move to GUST position:

1. Airspeed - FAIRED LIMITATIONS.
2. Gust control - RETURN TO FAIRED.

An adverse wing load distribution is created if only the wing flaps are in GUST position.

WING FLAPS AND AILERONS STUCK IN GUST

1. Airspeed - GUST LIMITATIONS.
2. Fuel - BALANCE FOR LANDING IN GUST CONFIGURATION.

Aileron control will be limited and "no flap" drag characteristics must be considered for landing.

WING FLAPS MALFUNCTION

There is no emergency method of extending the wing flaps. If the flaps cannot be extended due to hydraulic system failure or

other cause, a landing must be made as outlined in "Landing With Wing Flaps Retracted".

ASYMMETRICAL FLAP CONDITION

In the event that the left and right flap sections do not remain synchronized, they will be automatically stopped. This will occur after the two sides have reached a maximum difference of 5° in angle. They will remain in the stopped position and no cockpit action can be taken.

AIR CONDITIONING MALFUNCTION

AUTOMATIC TEMPERATURE CONTROL FAILURE

If the cockpit air becomes too hot or too cold and does not respond to the automatic temperature control rheostat, try the manual system. Turn the cabin heat selector to MANUAL HOT or MANUAL COLD as needed.

CABIN COOLER FAILURE

If air remains hot after manual adjustment, it indicates failure of the cabin cooler.

1. Reduce engine power to lower the inlet air temperature.
2. Check engine air defroster is OFF.
3. If the cockpit becomes unreasonably hot, select ram air - ON. The cockpit will be depressurized.

COOLER BYPASS VALVE FAILURE

If air remains cold after manual adjustment, it indicates failure of the cabin cooler bypass valve in a position which diverts all or most of the cabin air supply through the cooler unit.

1. Reduce engine power to lower the cold air flow.

SECRET

2. Turn on defroster.
3. If the cockpit becomes unreasonably cold, descend to a lower altitude where the outside air is warmer. Select ram air - ON. The cockpit will be depressurized.

PRESSURIZATION SYSTEM EMERGENCY OPERATION

The most frequent cause for loss of cockpit pressurization is engine flameout. There is no corrective action except to descend for an engine restart. If cockpit pressure is partially or completely lost for reasons other than engine flameout:

1. Oxygen - PRESS-TO-TEST.
2. Seal valves - ON.
3. Canopy seal dump valve - CHECK.
4. Cockpit air temperature - HOT.
5. Defroster - ON.
6. If it is necessary to remain at maximum altitude and the pressure suit is operating properly, do so for as long as physiological factors permit.
7. Descend to a safe altitude, if continued flight at altitude is not required.

NOTE

If it is necessary to remain at altitude or descend to low altitudes without pressurization, the windshield may become frosted. The cockpit fan and defroster should be used to minimize this condition.

FACE PLATE HEAT FAILURE

Failure of the face plate heat is evidenced by fogging of the face plate. A completely

separate system is attached to the left side of the face plate. To obtain emergency face heat, remove normal system wires on right side of the face plate and push in emergency face heat circuit breaker. There is no automatic temperature control in the emergency system. Limited temperature control can be obtained by pulling and resetting emergency face heat circuit breaker.

1. Normal face heat circuit breaker - PULL.
2. Normal face heat wires - REMOVE (R. H. SIDE)
3. Emergency face heat circuit breaker - PUSH IN.

COMMUNICATIONS FAILURE

Some communications failures are traceable to the pilot's personal equipment wiring. In these cases, service can be restored by using the bypass system, which will be under the pilot's safety belt on his left leg. This system is plugged directly into the helmet plug.

POGO RELEASE FAILURE

If a pogo fails to release after takeoff, make a straight in low approach. After the aircraft is slowed to threshold speed, the pogo will normally release. If the pogo does not release, burn fuel down to 550 gallons before landing.

WARNING

Do not fly over populated areas with a hung pogo as it may drop at any time.

CONDENSED CHECKLIST

Pages 3-29 through 3-41 contain a condensed checklist.

E

U-2 CONDENSED CHECKLIST
EMERGENCY PROCEDURES

NOTE

The following checklist is a condensed version of the aircraft emergency procedure checklist.

ENGINE FAILURE ABOVE 45,000 FT.

1. Oxygen regulator "Press-To-Test" as necessary.
2. Throttle OFF as soon as engine failure is recognized.
3. Unnecessary electrical equipment OFF.
4. Establish 115 knot IAS glide to a suitable landing area, for max. range. Otherwise, make fast descent.
5. Glide down to 35,000 ft. before attempting an airstart.

ENGINE VIBRATION

1. Slowly adjust engine RPM for minimum vibration.
2. Exhaust gas temperature - MONITOR.
3. Ram air switch - ON. (If fire suspected)
4. LAND AS SOON AS POSSIBLE.

AIR START PROCEDURE (NORMAL SYSTEM)

1. Airspeed & RPM - HOLD 150-180 KNOTS AND 15% RPM OR MORE.

U-2
1 March 1959

E

U-2
1 March 1959

E

2

2. Generator - battery switch - BAT.
3. Inverter - ON.
4. Throttle - IDLE
5. Ignition - START & HOLD.
6. Generator - battery switch - GEN - BAT.
7. If start does not occur after 30 seconds of ignition - PLACE THROTTLE OFF, DRAIN TAILPIPE AND REPEAT 1 - 6 ABOVE.
8. If start attempt is still unsuccessful - ACCOMPLISH PROCEDURES OUTLINED FOR AIR START PROCEDURE (EMERGENCY SYSTEM)

AIR START PROCEDURE (EMERGENCY SYSTEM)

1. Throttle - OFF
2. Airspeed & RPM - HOLD 150-180 KNOTS AND 15% RPM OR MORE.
3. Generator - battery switch - BAT.
4. Inverter - ON.
5. Fuel system selector switch - EMER.
6. Throttle - 1/4 TO 1/3 OPEN.
7. Ignition - START & HOLD.
8. Throttle - ADJUST.
9. Generator - battery switch - GEN - BAT.

ENGINE OVERSPEED

1. Throttle - OFF.
2. HEAD FOR NEAREST SUITABLE LANDING FIELD.
3. MAKE NORMAL AIRSTART.

E

4. If overspeed condition persists - SWITCH TO EMERGENCY FUEL SYSTEM WITH THROTTLE IN IDLE.
5. If overspeed condition still persists - THROTTLE OFF AND ATTEMPT AIRSTART ON EMERGENCY FUEL SYSTEM.
6. If overspeed still exists - ATTEMPT FUEL CONTROL REGULATION WITH THROTTLE BETWEEN IDLE AND OFF.
7. If overspeed cannot be controlled - THROTTLE OFF AND GLIDE FOR FLAMEOUT LANDING.

ENGINE OFF IDLE STALL

1. Throttle - IDLE.
2. Fuel system selector switch - EMER.
3. Throttle - ADVANCE CAREFULLY.
4. Fuel system selector switch - NORMAL.

FLAMEOUT LANDING PATTERN

HIGH KEY POINT

1. Altitude - 1500 FEET ABOVE THE GROUND.
2. Airspeed - THRESHOLD PLUS 30 KNOTS.
3. Landing gear - DOWN.
4. Wing flaps - UP.
5. Speed brakes - RETRACTED.

U-2
1 March 1959

E

3

U-2
1 March 1959

4

LOW KEY POINT

1. Altitude - 750 FEET ABOVE THE GROUND.
2. Airspeed - THRESHOLD PLUS 20 KNOTS.
3. Landing gear - DOWN.
4. Wing flaps - AS REQUIRED.
5. Speed brakes - RETRACTED.

TURN TO BASE LEG

1. Altitude - 500 FEET ABOVE THE GROUND.
2. Landing gear - DOWN.
3. Wing flaps - AS REQUIRED.
4. Speed brakes - RETRACTED.
5. Airspeed - THRESHOLD PLUS 10 KNOTS AFTER TURN.

FINAL APPROACH

1. Airspeed - REDUCE TO THRESHOLD PLUS 5 KNOTS.
2. Wing flaps - FULL DOWN IF REQUIRED.
3. Speed brakes - OUT WHEN RUNWAY IS ASSURED.
4. Airspeed - REDUCED TO THRESHOLD.
5. Drag chute - DEPLOY.

LANDING WITH WING FLAPS RETRACTED

1. Speed brakes extended. (If available)
2. Threshold altitude properly controlled.
3. Threshold speed properly controlled.
4. Deploy drag chute.
5. Engine power - Cut off when landing is assured.

LANDING ON UNPREPARED SURFACE

1. Ejection safety pin - INSTALLED.
2. Face plate - REMOVED AND STOWED.
3. Oxygen - OFF
4. Parachute and suit connections - UNFASTEN.
5. Landing gear - DOWN.
6. Speed brakes - AS REQUIRED.
7. Wing flaps - AS REQUIRED.
8. Make a normal approach.
9. Throttle - OFF WHEN FIELD IS ASSURED.
10. Main fuel shut-off switch - CLOSED.
11. Battery switch - OFF.
12. Evacuate aircraft as soon as possible after landing.

DITCHING PROCEDURE

1. Transmit MAYDAY message.
2. Canopy - JETTISON.
3. Suit capstan connection - DISCONNECT.
4. Parachute - UNBUCKLE.
5. Shoulder harness - LOCKED.
6. Gear, speed brakes and flaps - RETRACTED.
7. Throttle - OFF.
8. Just before touchdown, all switches - OFF.

EMERGENCY DESCENT (MANUAL)

1. Landing gear - DOWN.
2. Gust control - FAIRED.
3. Speed brakes - EXTEND.
4. Throttle - REDUCE TO MINIMUM PR.
5. Descent - 2 "G", 60 DEGREE SPIRAL.

U-2
1 March 1959

5

U-2
1 March 1959

6

6. Airspeed - NEEDLES TOGETHER.
7. Gust control - GUST AT 45,000'.

EMERGENCY DESCENT (AUTOPILOT)

1. Pull the green apple. (If there is any question of oxygen supply.)
2. Extend the landing gear.
3. Gust control - GUST.
4. Autopilot and Mach sensor - REENGAGE at 10 to 20 knots below needle.
5. Extend the speed brakes.
6. Retard the throttle and maintain minimum P. R.
7. Discontinue at 40,000 to 35,000 ft. Reengage at 160 kt. to prevent structural failure.

GROUND FIRE

1. Throttle - OFF.
2. Fuel shutoff valve - CLOSED.
3. Generator-battery switch - OFF.
4. Oxygen valves - OFF.
5. Evacuate aircraft as soon as possible.

FIRE OR OVERHEAT LIGHT WHILE AIRBORNE

1. Throttle - Minimum practical power.
2. Signs of fire - CHECK.
3. If fire is evident, throttle - OFF.
4. Main fuel shutoff valve - OFF.
5. Make decision to bailout or execute emergency "deadstick" landing.

6. If warning light is only indication of fire, continue at reduced power and land as soon as possible.

COCKPIT SMOKE

1. Defroster - OFF.
2. Temperature control - COLD.
3. Generator - battery - OFF.

If smoke is so bad that the mission cannot be continued:

4. Throttle - REDUCE POWER AND START DESCENT.
5. Ram air - ON IF SMOKE PERSISTS.
6. Throttle - OFF IF SMOKE CONDITION REMAINS HAZARDOUS.
7. Canopy - JETTISON IF NECESSARY.

PRIOR TO BAILOUT

1. Aircraft speed - REDUCED IF EXCESSIVE.
2. Emergency oxygen supply - PULL GREEN APPLE.
3. Helmet tiedown - TIGHTENED.
4. Emergency face heat wires - DISCONNECT.
5. Seat pack disconnect - DISCONNECT.
6. Radio call - TRANSMIT "MAYDAY".
7. Destruct system - ARM AND ACTUATE.

BAILOUT WITH EJECTION SEAT

1. Proper body position - ASSUME.
2. Seat ejection "D" ring - PULL AND HOLD.

U-2
1 March 1959

7

U-2
1 March 1959

8

BALLOUT WITH NON-EJECTION SEAT

1. Seat - LOWERED.
2. Seat pack quick disconnect - DISCONNECTED.
3. Canopy - JETTISON WITH HEAD LOW.
4. Automatic parachute opening device - PULL IF AT ALTITUDE.
5. Seat belt and harness - DISCONNECTED.
6. Bailout - DIVE OVER THE RIGHT SIDE.

SUSPECTED OXYGEN DIFFICULTY

1. Pull green apple.
2. Actuate "Press to Test" button on seat pack.
3. Inspect suit "T" fittings and seat pack quick-disconnect.
4. Check face plate and locking bar for security.
5. Make emergency descent on autopilot.

LANDING GEAR EMERGENCY EXTENSION

1. Gear handle - DOWN.
2. Uplock release - PULL.
3. Gear down and locked indication - CHECKED.
4. Airspeed - INCREASE IF NECESSARY TO ASSIST IN LOCKING THE GEAR.

FUEL LOW LEVEL INDICATION IN LEVEL FLIGHT AT ALTITUDE

FIELD WITHIN 100 NM

1. Declare emergency.
2. Continue flight at altitude to 50 NM from landing area.
3. When within 50 NM, make a "FAST DESCENT" to field.
4. Land from flameout pattern.

FIELD WITHIN 200 NM

1. Declare emergency.
2. Continue flight at altitude to within 150 NM.
3. When within 150 NM, make a "FAST DESCENT" to 50,000 feet.
4. Shut down engine at 50,000 feet (Glide 115K).
5. Start engine when over the field.
6. Land from flameout pattern.

FIELD WITHIN 300 NM

1. Declare emergency.
2. Continue flight at altitude to 200 NM from landing area.
3. Shut down engine (Glide 115K).
4. Restart engine when over the field.
5. Land from flameout pattern.

FIELD WITHIN 400 NM

1. Declare emergency.
2. Continue flight at altitude or climb to maximum altitude until fuel is exhausted.

U-2
1 March 1959

9

U-2
1 March 1959

10

- 3. Establish maximum range glide speed.
- 4. Make "DEADSTICK" landing.

FUEL LOW LEVEL INDICATION DURING DESCENT

MORE THAN 100 GALLONS

- 1. Assume level flight.
- 2. Monitor fuel counter until 10 gallons have been used.
- 3. If sump tank refills, CONTINUE DESCENT.
- 4. If sump tank doesn't refill, DECLARE AN EMERGENCY.
- 5. Land immediately from flameout pattern.

LESS THAN 100 GALLONS

- 1. Declare an emergency.
- 2. Continue descent.
- 3. Land immediately from flameout pattern.

HIGH LOADMETER READING

- 1. Check electrical equipment individually to isolate cause.
- 2. Turn off malfunctioning equipment if unnecessary for further flight.
- 3. Land as soon as possible if mission cannot be successfully completed.

~~SECRET~~

ZERO LOADMETER READING

- 1. Operate item of electrical equipment - Check for increase in loadmeter reading.
- 2. If loadmeter remains at zero, gage is inoperative.

GENERATOR FAILURE

- 1. Battery-generator switch - BATT-ONLY position.
- 2. Unnecessary electrical equipment - OFF.
- 3. Use battery only as required.
- 4. Descend to 45,000 feet if possible.
- 5. Land as soon as possible.

COMPLETE ELECTRICAL FAILURE

- 1. Descend to 45,000 feet.
- 2. Land as soon as possible.

INVERTER FAILURE

- 1. Descend to 60,000 feet.
- 2. Maintain 88% RPM at this altitude.
- 3. Land as soon as possible.

ENGINE OIL SYSTEM MALFUNCTION

- 1. Oil pressure below 40 PSI - ABORT.
- 2. Oil pressure below 35 PSI - OPERATE AT LOWEST PRACTICABLE RPM AND LAND AS SOON AS POSSIBLE.

U-2
1 March 1959

11

U-2

1 March 1959

12

RUNAWAY TRIM (MANUAL FLIGHT)

1. Trim power cut-off switch-OFF.
2. Apply yoke force to overcome trim effect.
3. Extend speed brakes, lower landing gear and retard throttle to slow aircraft and reduce trim effectiveness.

RUNAWAY TRIM (AUTOPILOT FLIGHT)

1. Hold yoke to resist pressure and disengage autopilot.
2. Manually re-trim aircraft.
3. Turn trim power cut-off switch OFF and re-engage autopilot.
4. Dis-engage autopilot and retrim aircraft every 30 minutes.

GUST CONTROL MALFUNCTION

1. If either flaps or ailerons malfunction - check circuit breakers while observing "FAIRED" limitations.
2. Ailerons only in GUST - Observe "FAIRED" limits. Return ailerons to FAIRED when desired.
3. Ailerons stuck in GUST - Insure even fuel load and land from straight-in approach.
4. Flaps only in GUST-Return to FAIRED.
5. Flaps stuck in GUST - Reduce airspeed to 130 knots. Plan no flap landing.
6. Flaps and ailerons stuck in GUST-Balance fuel load and make straight in approach. Plan no flap landing.

CABIN COOLER FAILURE

1. Reduce power
2. Check defroster - OFF.
3. Ram air - ON if necessary.

CABIN COOLER BY-PASS VALVE FAILURE

1. Reduce power
2. Check defroster - ON.
3. Descend to warmer altitude if necessary.
4. Ram air - ON if necessary.

PRESSURIZATION FAILURE

1. Oxygen - Press-To-Test.
2. Seal valves - ON.
3. Canopy seal dump valve - CHECK.
4. Cockpit air temperature - HOT.
5. Defroster - ON.
6. Descend to safe altitude if possible.

FACE PLATE HEAT FAILURE

1. Normal face heat circuit breaker - PULL.
2. Normal face heat wires - REMOVE (R.H. Side).
3. Emergency face heat circuit breaker - PUSH IN.

U-2

1 March 1959

13

TABLE OF CONTENTS

	PAGE
AIR CONDITIONING AND PRESSURIZATION SYSTEM . . .	4-3
WINDSHIELD AND CANOPY DEFROSTING SYSTEM	4-7
OXYGEN SYSTEM	4-7
PERSONAL EQUIPMENT	4-9
COMMUNICATIONS AND ASSOCIATED ELECTRONIC EQUIPMENT	4-12
LIGHTING EQUIPMENT	4-17
DRIFT SIGHT SYSTEM	4-19
SEXTANT SYSTEM	4-24
WINDOW COVER JETTISON SYSTEM	4-29
HATCH WINDOW HEATER SYSTEM	4-31
PHOTOGRAPHIC EQUIPMENT	4-31
ELECTRONIC INTELLIGENCE SYSTEMS	4-39
F-2 FOIL SYSTEM	4-40
AFSWP NOSE SYSTEM	4-44
P-2 PLATFORM SYSTEM	4-45
APQ-56 RADAR MAPPING EQUIPMENT	4-49
WEATHER SURVEY EQUIPMENT	4-54
DESTRUCTOR	4-55
RADAR DOPPLER AUTOMATIC NAVIGATION SYSTEM (RADAN)	4-56
AN/ASN-6 LATITUDE AND LONGITUDE COMPUTER . .	4-59
MA-1 COMPASS SYSTEM	4-62
AUTOPILOT SYSTEM	4-65
MISCELLANEOUS	4-73

SECTION 4

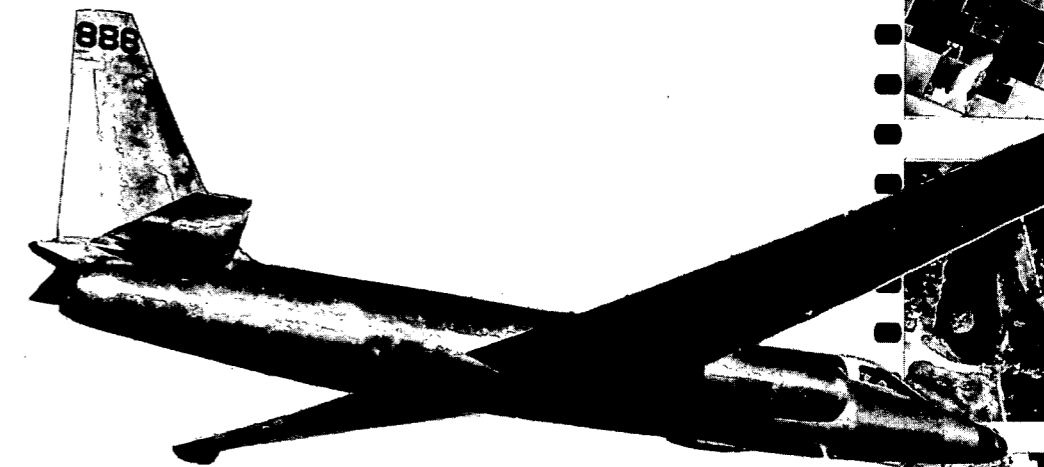
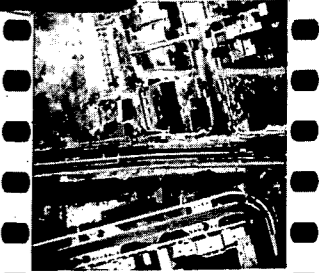
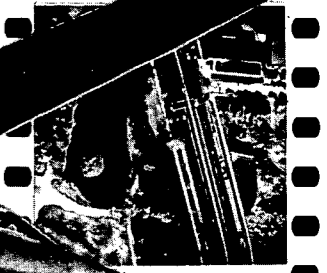
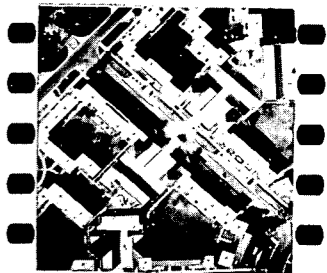
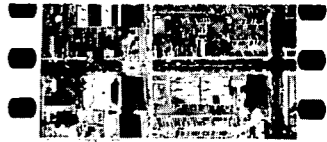
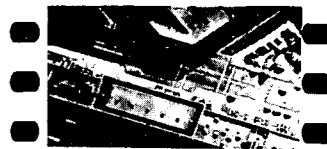

**DESCRIPTION & OPERATION
OF AUXILIARY EQUIPMENT**

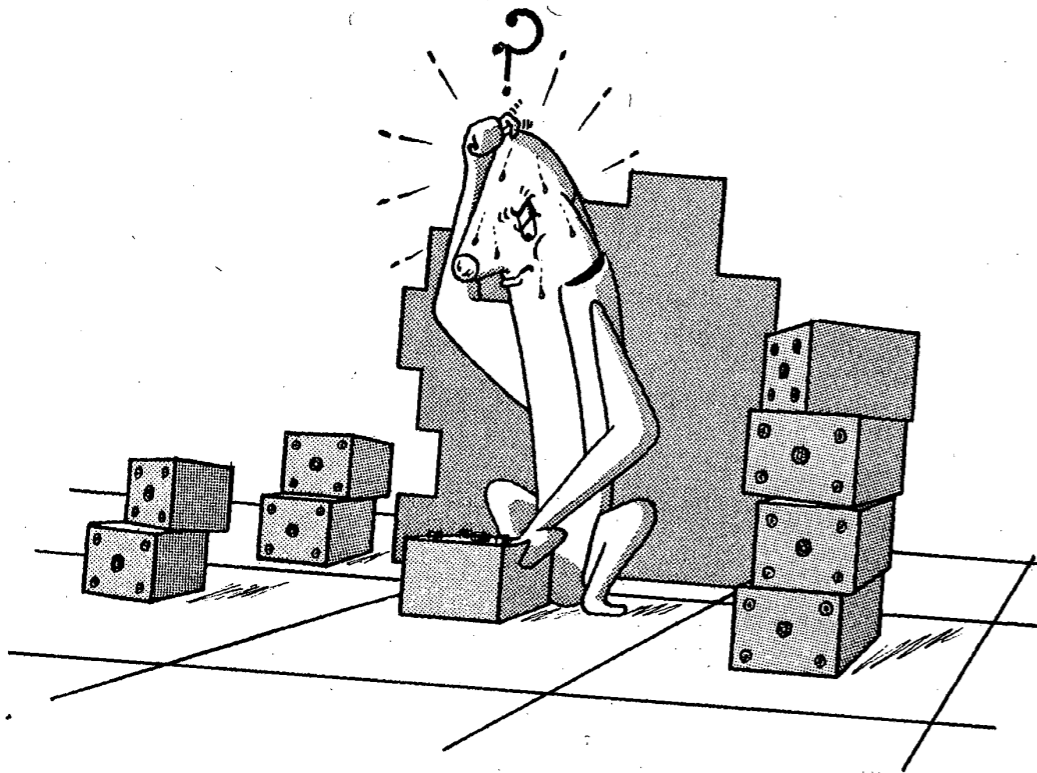

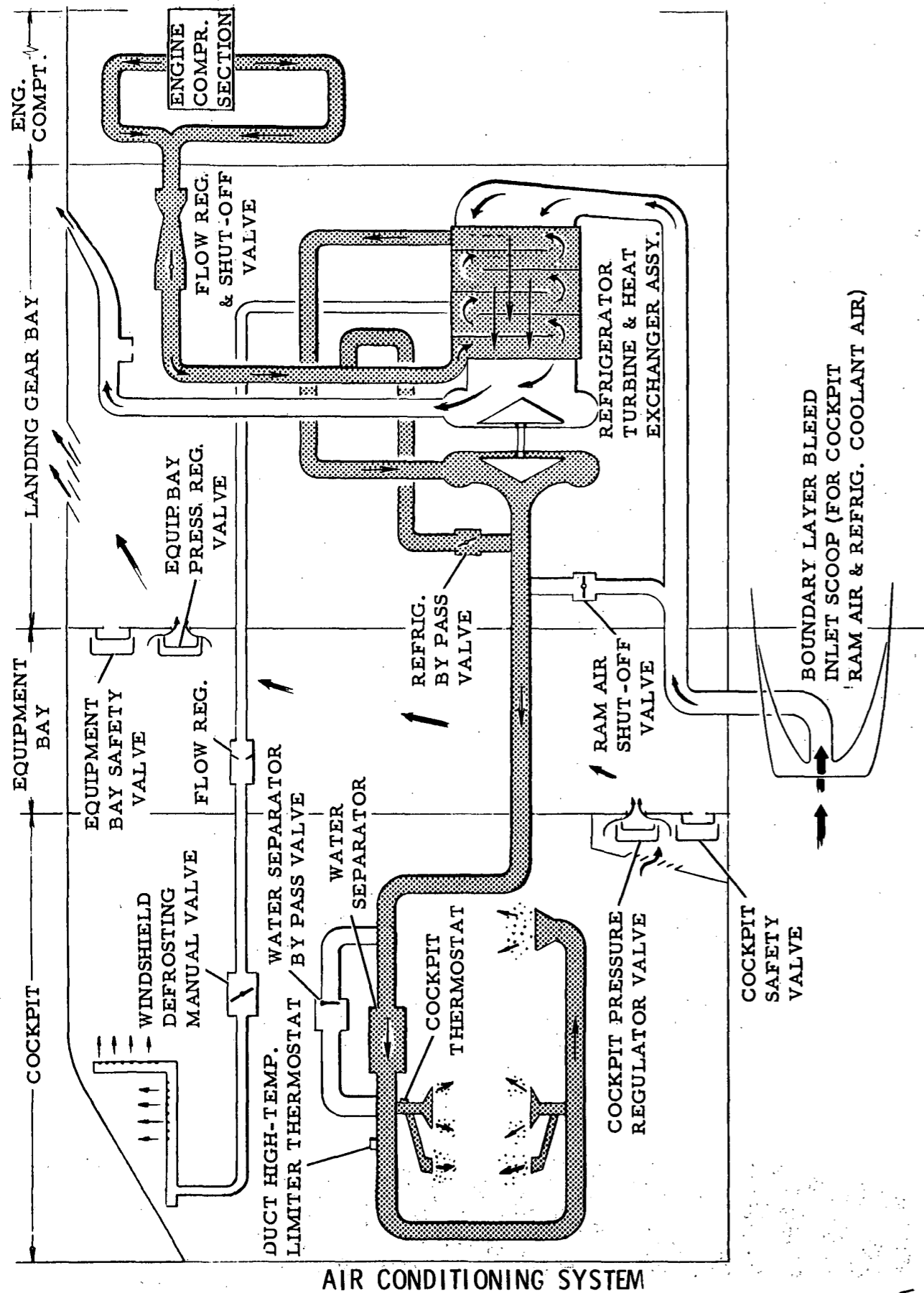

AIR CONDITIONING SYSTEM

FIG. 4-1

SECRET

Handwritten notes:
~~1 DC FAT-5~~
~~AF-2~~

AIR CONDITIONING AND PRESSURIZATION SYSTEM

GENERAL (See Figure 4-1)

Air conditioning and pressurization air is bled from the compressor section of the engine. It is cooled by a conventional aircraft type refrigeration unit, ducted through a water separator, and directed into the cockpit through five outlets. Cockpit exhaust air is discharged into the equipment bay through a cockpit pressure regulator valve which automatically maintains the cockpit pressurization schedule. This schedule is maintained regardless of the equipment bay pressure level, as the valve senses only true cockpit-to-ambient differential. After circulating through the equipment bay, the air is exhausted through a second pressure regulator valve into the unpressurized landing gear bay. This valve maintains essentially the same pressurization schedule in the equipment bay as that of the cockpit. This schedule provides a cabin altitude of 29 to 30 thousand feet at an airplane altitude of 70 thousand feet as shown in Figure 4-2.

In addition to the regulator valves, there is a safety relief valve in both the cockpit and the equipment bay to limit compartment pressures to structurally safe values in the event of a failed-closed regulator. To prevent excessive crushing pressures on the fuselage during high rates of descent, vacuum relief is provided by automatic opening of both the regulator and the safety relief valves.

CABIN HEAT SELECTOR

Located in the lower left corner of the instrument panel, the four position cabin heat selector is used to select either manual or automatic temperature control. Normally, the selector is left in the AUTO position, in which case it is only necessary for the pilot to set the automatic temperature control to a position which gives a satisfactory temperature. The cockpit thermostat will then control the electrical positioning of the refrigerator bypass valve so as to maintain the selected temperature. A separate thermostat in the duct downstream of the water

separator acts as an automatic override to limit the duct temperature to a safe high value.

If the pilot desires more heat than can be obtained with the selector set on AUTO and the automatic temperature control adjusted full HOT, or if the automatic control system malfunctions, the cabin heat selector should be set to HOLD TEMP. This removes the automatic temperature control rheostat from the system. Temperature control is then accomplished by manually regulating the electrically driven refrigerator bypass valve. To drive the valve further open for more heat, turn the selector to HOT for just a few seconds and then return it to HOLD TEMP. Cooler settings are obtained by momentarily selecting COLD and then returning to HOLD TEMP. A short time is required for the cabin inlet temperatures to stabilize after repositioning the bypass valve.

CAUTION

Never leave the cabin heat selector in the HOT position. This will drive the refrigerator bypass valve full open and will result in extremely hot air to the cockpit. An appreciable amount of time will be required to cool the ducts sufficiently for the cabin inlet air to again be comfortable.

CABIN HEAT AUTOMATIC TEMPERATURE CONTROL

The cabin heat automatic temperature control is a rheostat immediately to the right of the cabin heat selector. It is used to set the desired cabin temperature whenever the selector is on AUTO. When the selector is on HOLD TEMP., this rheostat is not effective.

PRESSURIZATION SCHEDULE

Figure 4-2

SECRET

NOTE

It is recommended that the cabin temperature at cruise altitude be maintained on the high side to assist in keeping the camera equipment warm.

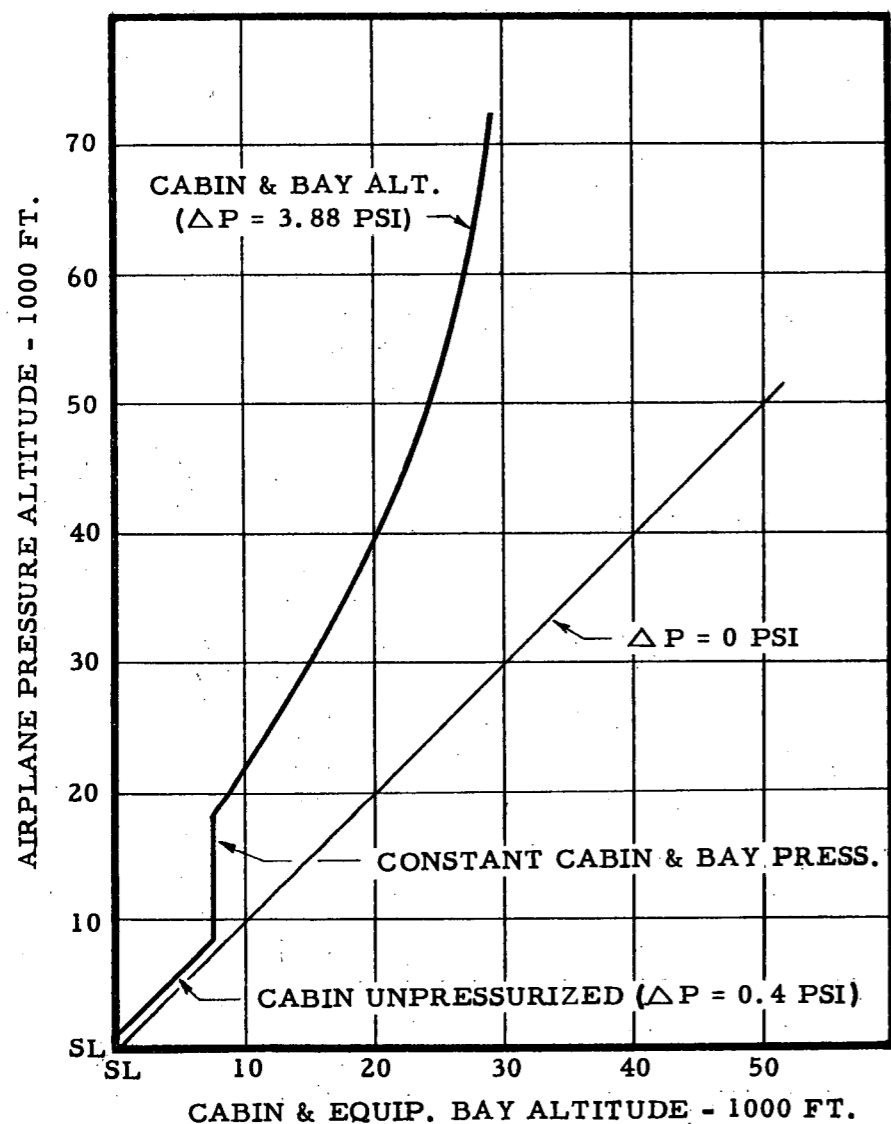
RAM AIR SWITCH

The ram air switch is a two position toggle type located on the left side of the instrument panel immediately below the turn and slip indicator. It is normally left in the OFF position, allowing normal operation of the air conditioning and pressurization system. Three primary functions are performed by turning the ram air switch ON:

1. The flow regulator and shutoff valve is closed, blocking the flow of engine compressor bleed air into the air conditioning and pressurization system.
2. The ram air shutoff valve is opened, supplying ram air to the cockpit from the right hand boundary layer bleed scoop. This air is introduced downstream of the turbine discharge, passing through the water separator and into the cabin.
3. The cockpit and equipment bay safety relief valves are opened, dumping all pressurization.

As a secondary function, turning the ram air switch ON runs the refrigerator bypass valve full closed, preparing the system for re-pressurization.

NOTE

It takes approximately three seconds for the ram air system to operate after turning the switch ON.

No control is provided for ram air temperature or flow. Also, since the engine bleed air is shut off, no hot air is available for windshield defogging during ram operation.

SEAL PRESSURE SYSTEM

To prevent pressurization leakage around the canopy and the upper and lower equipment bay hatches, inflatable seals are provided. Air pressure for the seals is supplied by the engine through a regulator which maintains a system pressure of approximately 17 to 18 psi. A check valve prevents bleed off of seal pressure in the event of engine flame-out. Selection of ram air ON does not deflate the seals, since the engine air for this system is obtained upstream of the air conditioning and pressurization system regulator and shutoff valve.

Operation of the canopy emergency release handle to jettison the canopy actuates a two position, three port valve in the canopy seal pressure line, automatically closing off the source pressure and dumping the seal pressure overboard.

CANOPY AND HATCH SEAL CONTROLS

Two manually operated seal pressure valves are provided on the left side console; one is to control the pressure to the canopy seal, the other to the hatch seals. Each of these valves is a three port, two position type. Selecting OFF connects the respective seal to the exhaust port (cockpit ambient) while blocking the pressure source; selecting ON connects the pressure source to the seal while blocking the exhaust port.

PRESSURIZATION ALTIMETER

An altimeter, located on the right side of the instrument panel just above the right side console and labeled CABIN ALTITUDE, is provided to monitor both cockpit and equipment bay pressures.

PRESSURIZATION ALTIMETER SELECTOR SWITCH

A two position selector switch is provided on the right side console to connect either the cockpit or the equipment bay pressure to the cabin altitude indicator.

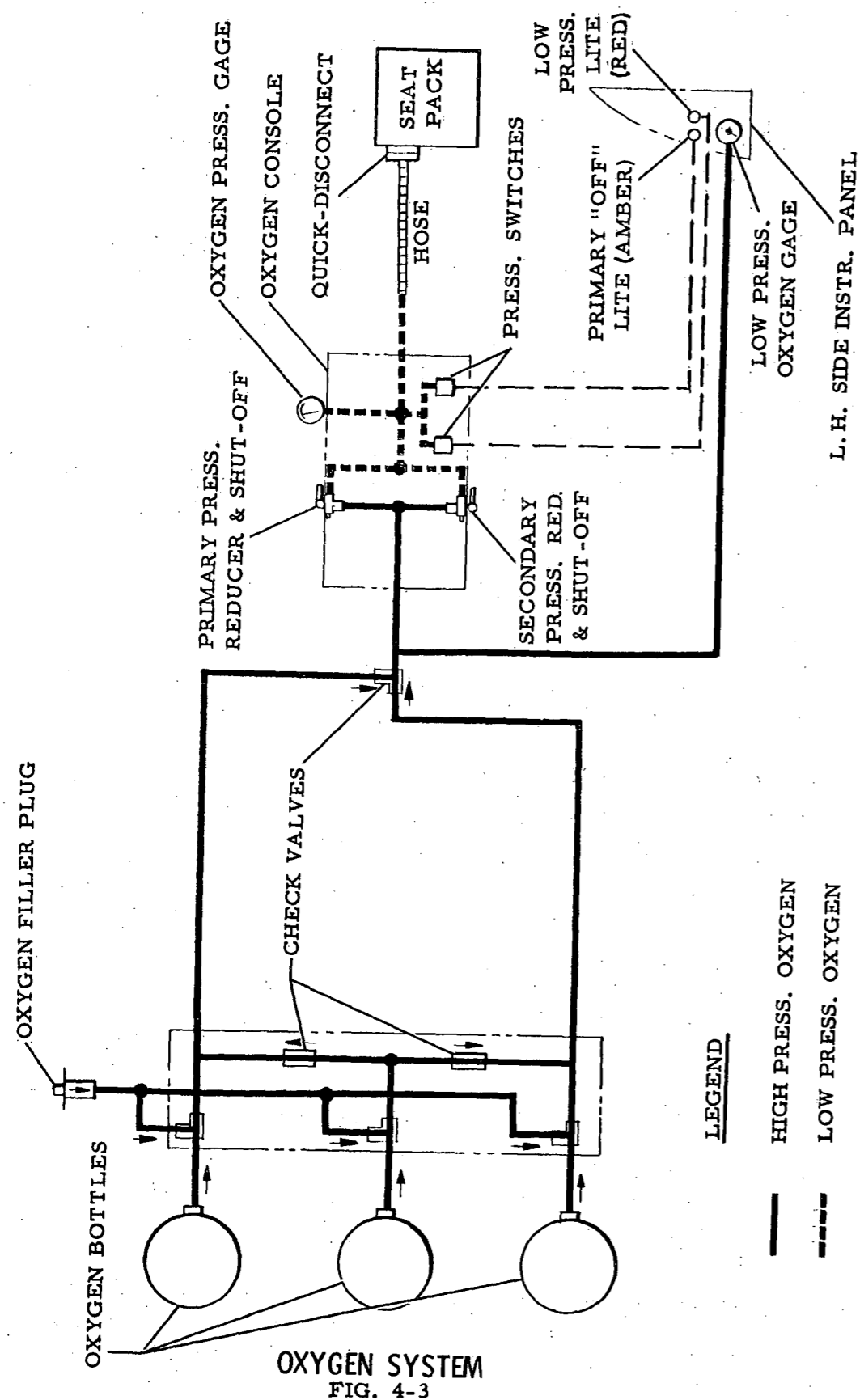

SECRET

NOTE

It is recommended that the pressurization altimeter selector switch normally be left in the EQUIP. BAY ALTITUDE position since it is not possible to lose cabin pressure without losing equipment bay pressure. Some aircraft have this switch guarded in the recommended position.

WINDSHIELD AND CANOPY DEFROSTING SYSTEM

PRIMARY DEFROSTING SYSTEM

The windshield and canopy primary defrosting system is supplied by hot bleed air from the second stage of the air conditioning and pressurization system refrigeration unit. This air is ducted through a flow limiting regulator to a manifold along the bottom edge of the windshield and the forward edge of the canopy.

When using the J57-P-37 engine, this system may be the source of oil on the windshield.

CANOPY DEFROST CONTROL VALVE

A manually operated butterfly valve is provided to adjust the flow below the regulated maximum. The canopy defrost control is located on the right console and may be set to a number of detents between full CLOSED and full OPEN.

DEFROST FAN

A small two-speed, rubber-bladed fan mounted on the left side of the canopy constitutes a second defrosting system. The general circulation provided by this fan is usually enough to keep the canopy free of frost.

Pilot comfort and visibility are usually aided by keeping the engine air defroster off and using the electric fan. The fan is also useful during engine out descents as an aid to wind-

shield defrosting.

DEFROST FAN SWITCH

A three position center OFF switch is installed on the left console for operating the defrost fan. The forward position is for HI and the aft position for LO speed.

OXYGEN SYSTEM

GENERAL

The high pressure dual oxygen system consists of three 514 cubic inch cylinders, a filler valve, check valves, two pressure reducer shutoff valves, a high pressure gage, a low pressure gage, two pressure switches and two press-to-test warning lights as shown in Figure 4-3. The high pressure storage cylinders are located in the main landing gear bay with the filler on the left side of the fuselage just below the wing leading edge. The check valves and lines are arranged so that one blocked or broken line anywhere between the bottles and the cockpit will result in the loss of only one or two of the three bottles, depending on the nature of the trouble.

The system is normally serviced to 1800 psi and has a capacity sufficient to supply a normal flow of oxygen to the pilot for a period of time in excess of the maximum duration of the airplane. See SECTION II for oxygen average consumption schedule. The high pressure gage is located on the left forward panel.

The oxygen control panel is located on the left console. It includes two combination pressure reducer shutoff valves, two pressure switches, and a low pressure gage. In addition, two oxygen low pressure warning lights are located on the left forward panel adjacent to the high pressure gage.

The dual pressure reducer system is provided to prevent the blockage of one reducer from cutting off the pilot's oxygen supply. Icing is the most probable cause of blockage

SECRET

FM-3

see Tech Data Change
of a pressure reducer. Therefore, when blockage of the primary reducer does occur, it is assumed to be due to water in the oxygen and this will eventually result in blockage of the secondary reducer unless corrective measures are taken as detailed in EMERGENCY PROCEDURES. The pressure settings of the reducers and of the low pressure warning switches are:

Primary reducer	82 psi ± 2 psi
Secondary reducer	68 psi ± 2 psi
Primary off light (amber)	72 psi ± 2 psi
Low pressure light (red)	60 psi ± 2 psi

A quick disconnect oxygen fitting which includes the pilot's electrical connections completes the aircraft section of the oxygen system. Certain aircraft are equipped with a manual release type quick disconnect located on the side of the left console, and the other aircraft contain an automatic release type located on the floor near the right side of the control column. Both types of disconnect systems are provided with a check valve to prevent oxygen flow when the pilot's personal equipment is disconnected.

The pressure reducer shutoff valves are provided with guards which are engaged in the ON position.

NOTE

Some aircraft may still have the single supply oxygen system. This installation has no low pressure indicator and no pressure switches or warning lights. The only control is one pressure reducer shutoff valve on the left console. The system high pressure indicator is on the left forward panel.

PRE-FLIGHT CHECK *see Tech Data Change*

FM-3

1. Check the system pressure on the high pressure gage. It should be 1700 to 1850 psi.

2. Turn only the primary oxygen valve ON. The low pressure gage should read approximately 82 psi and both the amber PRIM OFF and the red LOW PRESS warning lights should be off. Normal breathing momentarily reduces the low pressure reading 1 to 3 psi and does not affect the lights.
3. Turn secondary oxygen valve ON. There will be no change in indications.
4. Turn primary oxygen valve OFF. The PRIM OFF light should come on and the low pressure gage drop to approximately 68 psi.
5. Turn secondary oxygen valve OFF momentarily and check that the LOW PRESS warning light comes on. Turn secondary valve back ON to restore oxygen flow.
6. Turn primary oxygen valve ON. With both oxygen valves on, check that both warning lights are out and that the low pressure gage reads approximately 82 psi.

NORMAL OPERATION

FM-3

1. Check the system pressure on the high pressure gage. It should agree approximately with the oxygen average consumption schedule shown in SECTION II.
2. With both oxygen valves ON the low pressure gage should read approximately 82 psi and both warning lights should be out.

NOTE

As the system high pressure drops according to the oxygen consumption schedule, the low pressure readings will tend to increase a few psi.

3. A blockage of the primary oxygen valve will normally be indicated by the amber PRIM OFF light coming on. In this

event, proceed as directed in EMERGENCY OPERATION.

4. As an independent check that the primary system is operating properly, turn the secondary oxygen valve OFF momentarily about every half hour. There should be no change in pressure readings and the warning lights should remain out. If the primary system is blocked, the pressure will drop below ⁵⁰60 psi and both warning lights will come on, indicating that only the secondary system was working. In either case, turn the secondary valve back ON. If the primary system was blocked, proceed as directed in EMERGENCY OPERATION.

EMERGENCY OPERATION

FM-3

see Tech Data Change

In the event that the primary oxygen regulator is blocked but the low pressure reading is above ⁵⁰60 psi:

1. Turn the primary regulator OFF to permit it to warm up and thaw out.
2. Turn the cabin heat up as high as practical to aid in thawing the primary valve.
3. Descend to a safe altitude if operational requirements permit. If it is not possible to descend to a safe altitude:
4. Every ten minutes turn the primary oxygen valve ON momentarily to determine whether the blockage has cleared. When this check results in the PRIM OFF lights going out and the low pressure readings returning to normal, the primary valve should be left ON.

If, when operating on the secondary valve only, the LOW PRESS warning light comes on and/or the low pressure gage reading drops below ⁵⁰60 psi:

1. Turn the primary valve ON.
2. Recheck the low pressure gage reading.

It will return to approximately 82 psi if the primary reducer valve is clear. If the pressure remains below ⁵⁰60 psi, pull the green apple and descend to a safe altitude

PERSONAL EQUIPMENT

GENERAL

The pilot's specialized personal equipment includes a pressure suit, matching helmet and seat pack. The seat pack is attached to the parachute harness and stays with the pilot on bail out. The following items are contained in the seat pack: survival gear, oxygen regulator, and emergency oxygen supply.

SEAT PACK DISCONNECT

The quick disconnect fitting connects the seat pack to the ship's oxygen supply and also provides the electrical connections for face plate heat and communications. On airplanes with the manual quick disconnect fitting mounted on the left console, the ring on the top of the fitting is turned crossways to the aircraft for locking. In order to disconnect, the ring must be rotated 90°, aligning it with the aircraft.

On those aircraft having the disconnect on a flexible line and stowed at the lower right side of the control column, attachment is accomplished by aligning the two halves and pressing together while depressing the thumb button lock on the face of the ship's half. When properly latched in, the thumb button resets to allow insertion of the lock pin. When the lock pin is in place, the disconnect cannot be separated accidentally.

A cable connects the ship's half of the automatic disconnect to the floor of the aircraft and, upon ejection, automatically activates the seat pack emergency oxygen system when the disconnect separates. To disconnect without operating the emergency oxygen system, it is necessary to remove the safety pin and press the thumb button while pulling

the two halves apart.

SEAT PACK

The pilot's seat pack houses the oxygen regulator and emergency oxygen supply. There are two types of seat packs used in this airplane. Basically, they are the same except for the disconnect. One uses a disconnect on a flex line that mates to the left console disconnect. The other one has the disconnect attached on the front right side. This disconnect mates to the airplane half attached to the floor.

SEAT PACK REGULATOR

The seat pack oxygen regulator maintains a breathing pressure of 3 to 4 inches of water up to a cabin altitude of approximately 39,000 feet. Above this altitude it delivers oxygen for breathing and for the suit capstans on the following pressure schedule:

Altitude	Breathing Press.	Suit Press.
	In. H ₂ O	PSI
45,000'	17.6	3
50,000'	31.2	6.2
60,000'	49.1	10
70,000'	60.1	12

A push-to-test button is located on the front of the seat pack. Holding this button down causes the oxygen regulator to increase both the breathing and the suit capstan pressures. This is used to periodically check the regulator.

EMERGENCY OXYGEN SUPPLY

The emergency oxygen supply is contained in a 57 cubic inch high pressure bottle fastened to the seat pack. It is provided to supply suit and breathing pressures in the event that the ship's system becomes inoperable and/or during bail out. This bottle will furnish oxygen for a period of 15 to 20 minutes, which

is sufficient for emergency descent to a safe altitude.

An emergency oxygen high pressure gage shows through a hole in the top of the pack. The bottle is normally charged to 1850 psi. Actuation of the emergency oxygen supply is accomplished by extraction of a release pin from its engaged position. A flexible cable is connected to this pin and the other end terminated in a cable knob, commonly called the "green apple". Seat packs for use in aircraft with the automatic disconnect have a second cable attached to the release pin and terminated in an automatic lever arm in the seat pack half of the disconnect. Separation of the disconnect halves during ejection automatically extracts the pin. Manual extraction is accomplished by pulling the green apple.

NOTE

Once the emergency oxygen supply has been activated, it cannot be deactivated until the bottle empties. Therefore, the bottle must be recharged on the ground whenever the release pin has been extracted.

When the emergency oxygen supply is actuated, a reducer drops the high pressure to 50 psi. A shuttle valve at the input to the seat pack regulator prevents flow from the seat pack to the aircraft system. However, if the emergency system is inadvertently operated while the aircraft system pressure is above 50 psi, the shuttle valve will select the aircraft oxygen and prevent the unnecessary depletion of the emergency supply. However, if the green apple has been pulled, the pilot has no way of determining whether the emergency supply has been or is being depleted.

A relief valve is provided to prevent an excess of pressure to be delivered to the seat pack regulator by a malfunctioning reducer. This valve is set to operate at 130 psi \pm 10 psi.

SURVIVAL GEAR

The survival gear is carried in a fiberglass container within the seat pack. Contents of the container vary and are normally dictated by a specific mission. A nylon lanyard 25 feet long attaches the survival gear container to the seat pack. A 'Switlick' slidefastener quick release allows the container and a life raft, if carried, to be released from the seat pack during a parachute descent. The life raft is attached to the survival gear container lanyard 15 feet from the seat pack attaching point.

EQUIPMENT SELECTION *see Tech Data Change*
see FM-1 FM-3

On all flights above 45,000 feet, the pressure suit is mandatory.

Below 45,000 feet, an oxygen mask and a Lombard or P4 helmet may be used instead of the pressure suit if desired.

WARNING

The MA 2 pressure helmet should not be worn without the suit as it requires tiedown provisions. Loss of cabin pressure can cause the helmet to rise dangerously high or it could be torn off during bailout causing loss of oxygen facilities.

When wearing an oxygen mask, the use of the standard seat pack will result in garbled radio transmissions and breathing discomfort due to the 3 to 4 inches of water breathing pressure. This may be remedied in one of three ways:

- Modify several seat packs as low altitude packs by lowering the pressure setting of the regular seat pack regulator.
- Insert a restrictor in the line between the seat pack and the oxygen mask.

NOTE

If this method is used, check that adequate breathing pressure is available in the event of loss of cabin pressure at 45,000 feet.

- Use an A-13 regulator which may be placed in the map case and connected to the ship's disconnect. A bailout oxygen bottle is used instead of the seat pack oxygen system since the connectors are not compatible. Therefore, cushions may be used in place of the seat pack if desired.

NORMAL OPERATION

For normal operation the pilot is suited up and is breathing oxygen prior to entering the airplane. Upon entering the aircraft, the primary reducer shutoff valve is turned ON and his oxygen source is changed from the walk-around bottle to the airplane. The oxygen system pre-flight check is made at this time. In addition to the aircraft system checks, the following should be done to check the seat pack system:

- Push the press-to-test button on the seat pack. Note that the capstans inflate, the breathing pressure increases, and that there are no leaks. After maximum pressure is reached, hold breath for a few seconds to ascertain that there is no flow or sound of leaks.
- Release the button and the seat pack regulator will automatically bleed off excess capstan and breathing pressures.

It is recommended that the seat pack press-to-test button be operated about every half hour during flight.

EMERGENCY OPERATION

As long as the cabin pressure remains below approximately 41,000 feet, the seat pack provides breathing pressure only. If the cabin altitude goes above 41,000 feet due to flameout or other cause, the seat pack will

pressurize the suit as required. If the suit and breathing pressures do not respond fast enough or high enough as the cabin depressurizes, the press-to-test button should be used to increase the pressure.

As this is a pressure breathing system, the pilot has good warning of a stoppage or reduction in the oxygen flow. Should a stoppage or reduction in flow occur and he fail to see the warning lights, he will notice the helmet bladder collapse against his head as he inhales. When this happens, the green apple should be pulled immediately. If possible, a check of all connections should be made. Failure of a breathing hose or its connection, or separation of the disconnect can cause this trouble. If the failure is in a breathing hose, the emergency oxygen system cannot help the situation. If the trouble is upstream of the regulator, the emergency system will supply pressure to the seat pack regulator for 15 to 20 minutes.

In case of bailout, the personal equipment provides oxygen during the descent.

On those airplanes using the manual quick disconnect, the green apple should be pulled and the disconnect separated before bailing out or using the ejection seat. If time does not permit disconnecting, it will separate at the hose connection but requires a 120 pound pull. Successful bailouts have been accomplished without separating the disconnect.

On those airplanes using the automatic disconnect, the emergency oxygen supply is activated automatically upon ejection or when the seat kit is raised approximately 10" above the seat. If time permits, the green apple should be pulled to preclude failure of the automatic device.

If a bailout has been accomplished and a water landing is expected, the life raft should be released and inflated prior to landing. Pulling the red 'Switlik' release on the seat pack unlocks the slide fastener, inflates the life raft, and allows it and the survival gear container to fall free of the seat pack. A lanyard attaching the life raft, survival gear container and seat pack together keeps them within reach of the pilot upon landing.

COMMUNICATIONS AND ASSOCIATED ELECTRONIC EQUIPMENT

MICROPHONE AND HEADSET CONNECTORS

A special quick disconnect fitting which provides the pilot with a combination electrical and oxygen connection is mounted in the cockpit. The pilot's microphone and headset wiring is run through this connector. In some aircraft this disconnect is located on the in-board side of the left console; on other aircraft it is on the floor near the forward right edge of the seat. The floor mounted connection will automatically unlock and separate in the event of ejection. The console mounted connection is manually unlocked prior to separation.

A cable which bypasses the quick disconnect is stowed behind the seat. This cable can be used to connect a microphone and headset directly to the communications system. This cable is normally used by the pilot's assistant during pre-flight aircraft and equipment checkouts. The pilot's use of this cable will often improve the quality of communications. However, automatic disengagement of this connection is not provided for in the event that ejection is necessary.

MICROPHONE SWITCHES

Two microphone switches are provided. They are both of the momentary button type. One is located on the throttle grip and the other is on the left control wheel grip. They are both thumb operated.

C-823/AIC-10 INTERPHONE CONTROL

The Interphone Control is used in this aircraft primarily to improve the intelligibility of audio communication. The unit consists basically of an audio frequency amplifier which preamplifies the pilot's transmissions and boost-amplifies the radio receiver outputs.

The Interphone Control is also used as an intercom system to aid the pilot and his assistant perform their preflight aircraft

and equipment checkout. In this case the pilot uses the quick disconnect for his microphone and headset and the assistant uses the bypass cable. For intercom operation it is necessary to turn the recorder switch, located above the right console and next to the hatch heater switch, ON. Communication between the pilot and assistant may then be carried on without the use of mic switches and without transmission on the ship's radios. Use of the mic buttons on the throttle and the control wheel will permit normal radio transmission, however, no radio reception is possible with the recorder switch in the ON position.

The Interphone Control Unit is mounted on the cockpit left aft bulkhead. It has an AUX LISTEN-NORMAL switch which is safety wired to NORMAL. It also has a volume control which affects the level of all communications installed in the aircraft, both transmitting and receiving. Because of the location of this unit, the volume must be set before flight.

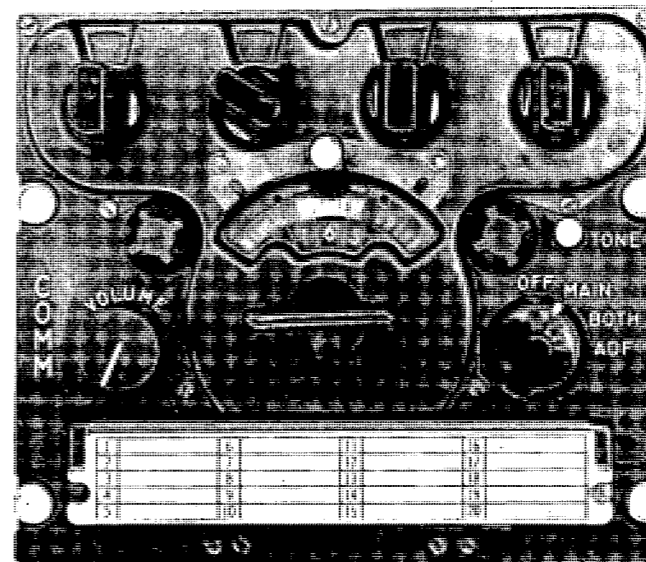

AN/ARC-34 CONTROL PANEL
Figure 4-4

AN/ARC-34 UHF TRANSCEIVER

General

A standard AN/ARC-34 UHF receiver-transmitter having a 10 watt output is provided for communications. This unit is located in the aft end of the equipment bay. The control

unit is located on the left hand console. See Figure 4-4. This radio provides for voice communication in the frequency band range of 225 to 399.9 megacycles. In this range there are 1750 separate frequencies available. Twenty of these can be preset and selected by number with the selector switch. Any of the others can be manually selected in the cockpit.

Operation

AN/ARC-34 circuit breaker in equipment bay must be closed.

1. Check the channel preset frequencies as indicated on the plastic write-in card. Change preset frequencies as required for the mission.
2. Close the interphone circuit breaker.
3. Rotate function switch to MAIN and allow at least one minute for the set to warm up.
4. Rotate the function switch to BOTH if simultaneous monitoring of the preset channel and the guard channel is desired.
5. Set the mode switch so that PRESET is visible through the clear window.
6. Select the preset channel using the channel selector so that the channel number appears in the clear window.
7. Before transmission of a message, check for operation and warm up of the transmitter by using either the microphone button or tone button and listening for side tone.
8. If it is desired to transmit and receive on a frequency not preset on the channel selector, place the mode switch in the manual position and set up the new frequency with the manual frequency selector knobs.
9. Turn the function switch to OFF to de-energize the set.

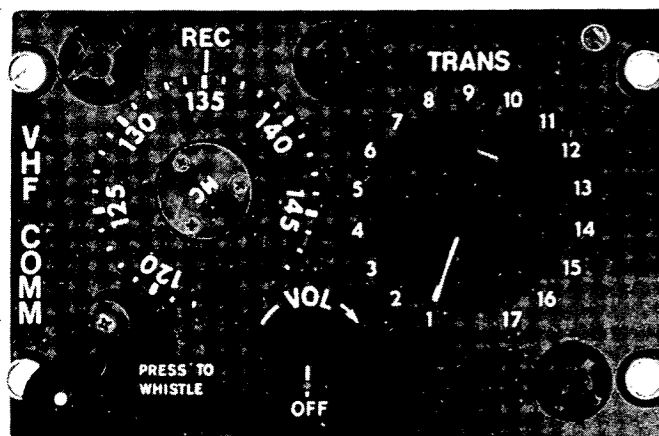

A. R. C. TYPE 12 CONTROL PANEL
Figure 4-5

AIRCRAFT RADIO CORP TYPE 12 VHF TRANSCEIVER

General

Certain airplanes are equipped with a VHF radio in addition to the AN/ARC-34. This set consists of a very high frequency receiver which covers the frequency range of 118 to 148 megacycles, a transmitter which covers the frequency range of 116 to 132 megacycles, a control panel, a power supply and an oscillator-relay unit. The control panel is shown in Figure 4-5. When the set is turned on, transmission is controlled by the microphone buttons on the throttle and on the control wheel. Five channels may be preset into the transmitter. No manual transmitter tuning is provided. The receiver must be manually tuned. A whistle-thru switch is provided which gives a high pitched side tone to aid in tuning. This side tone is adjusted to a maximum to get on-station. Simultaneous operation with the AN/ARC-34 may be conducted if both sets are turned on.

Operation

ARC-12 circuit breaker in equipment bay must be closed.

1. Close the interphone circuit breaker.
2. Turn set on by rotating volume knob clockwise from OFF position and allow one minute warmup.

3. Set the transmitter switch to the channel number corresponding to the desired transmitting frequency. Refer to the VHF frequency card on instrument panel.
4. Tune the receiver to the frequency corresponding to the desired receiving frequency. After coarse tuning by reference to the numbered dial, push in on tuning crank to obtain the high pitched side tone for fine tuning, tune side tone to maximum and release crank.
5. Turn the volume switch counterclockwise to OFF to de-energize the set.

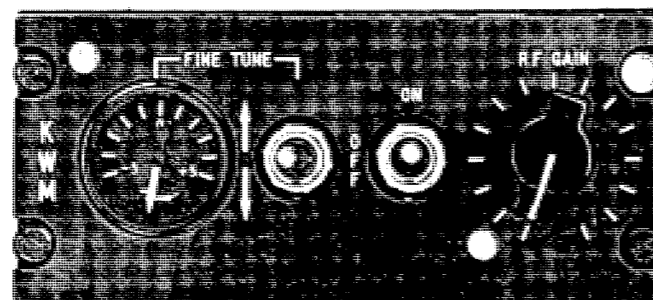

KWM-1 CONTROL PANEL
Figure 4-6

KWM-1 H. F. TRANSCEIVER

General

Certain aircraft are equipped with a KWM-1 H.F. radio. This is a single-sideband receiver-transmitter operating in the 14 to 30 megacycle frequency range on one preset channel, with a transmitted power output of 100 watts nominal. The range is not limited to line-of-sight at these frequencies as in UHF, therefore the 100 watt transmitter provides essentially around the world operation, especially when airborne. The relatively low frequencies used in the single sideband radio are affected by atmospheric conditions.

The KWM-1 transceiver and power supply are mounted either in the upper forward portion of the equipment hatch, or in a pressurized

box in the right side of the fuselage just forward of the wing. A wire antenna extends from the fuselage to the vertical fin. The control panel is located on the left console, adjacent to the seat. See Figure 4-6. On the control panel is a power ON-OFF switch, an RF gain control, a fine tuning control and a fine tuning indicator which is calibrated to read 0.5 kilocycles above and below the preset frequency. Alternator and D-C power are required to operate the set. In addition, inverter power is used to operate the tuning indicator.

In single-sideband operation, all of the transmitted power is contained in one sideband, providing much greater efficiency over amplitude modulated (AM) transmissions, where the power is contained by a carrier and two sidebands which are mirror images of each other as far as intelligence and power are concerned. The wasted power which is contained by the carrier and the second sideband in an AM transmission is applied to one intelligence bearing sideband in a single sideband transmission.

Simultaneous operation with the AN/ARC-34 and/or the ARC type 12 transceiver will result if these sets are turned on.

WARNING

Potentials dangerous to life are on the antenna during KWM-1 operation.

Normal Operation

KWM circuit breaker in equipment bay must be closed.

1. Turn A-C alternator switch ON.
2. Turn inverter switch ON.
3. Close interphone circuit breaker.
4. Turn ON-OFF switch on control panel to ON and allow approximately one minute for warmup.

5. Set RF gain for desired level.
6. Press microphone button to transmit.
7. If no signal is received or if signal is distorted, use fine tuning switch until received signals sound normal. The tuning indicator will not necessarily read zero at this setting, since there is a tendency for the tuning to drift slightly with time. Fine tuning simultaneously controls both the receiver and transmitter.
8. If the RF gain is initially set too high with the tuning way out of adjustment, it will be necessary to back off on the RF gain as the set is fine tuned to prevent distortion.

EMERGENCY OPERATION

The KWM-1 transmits the output of the ARA-26 keyer in emergencies. When the keyer is on, the KWM-1 will not transmit voice. Loss of A-C alternator power will result in KWM-1 failure. Inverter failure will only result in loss of tuning meter indication.

AN/ARA-26 KEYER

Certain aircraft have an AN/ARA-26 keyer which is a motor-driven device for automatically keying distress signals through the KWM-1 radio in an emergency. The control panel located on the right console contains an ON-OFF switch and an indicator light which glows when the keyer is operating. The keyer transmits three SOS signals, then the last four digits of the aircraft serial number three times, followed by a series of four second dashes spaced one second apart, six times. This series of signals will continue to be transmitted until the keyer switch is turned to the OFF position. The KWM-1 radio, when turned on, will transmit the coded output of the ARA-26 keyer. Voice transmissions cannot be made over the KWM-1 while the ARA-26 keyer is ON.

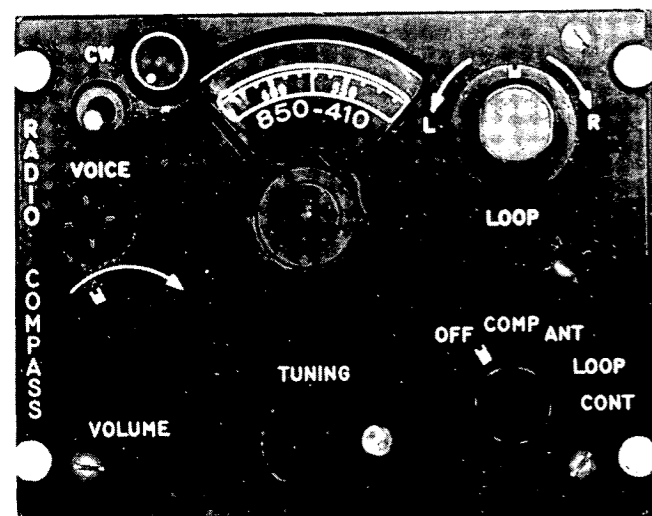

AN/ARN-6 CONTROL PANEL
Figure 4-7

AN/ARN-6 RADIO COMPASS

General

In most aircraft a standard AN/ARN-6 radio compass installation is provided having a frequency range of 100 to 1750 kilocycles. This radio compass provides navigational aid as well as aural reception. The control panel is located on the right hand aft console. See Figure 4-7. There are two needles on the compass indicator which are slaved together. The magnetic bearing can be read directly from the rotating card. The installation will give station reversal indication prior to crossing the station, usually 7 miles or one minute early, when at normal operational altitudes.

Function Switch

The function switch is used to turn the set on and select the type of operation. In the COMP position, the set functions as an automatic direction finder. In the ANT position, the antenna is switched from the loop to the sensing antenna. In the LOOP position, the loop can be manually rotated by the use of the loop left-right switch.

Loop L-R Switch

This switch is provided to permit manual control of the loop when the function switch is in the LOOP position.

Volume Control

This knob provides selection of the desired level of audio reception.

Voice - CW Switch

This switch provides selection of continuous wave or voice reception.

Band Switch

This switch provides selection of any one of four frequency bands which will be indicated on the tuning dial.

Tuning Crank

The tuning crank is used to tune the desired station for maximum signal strength as indicated by the audio reception.

Operation

Turn the set on by turning the function switch to COMP, ANT, or LOOP. Turn the set off by turning the function switch to OFF.

AN/ARN-44 RADIO COMPASS

Certain aircraft have the AN/ARN-44 radio compass in place of the AN/ARN-6. This set is similar to the ARN-6 except that the 100 to 200 kilocycle band has been replaced with a 2.0 to 3.5 megacycle band.

IFF

No IFF set is installed in the U-2 at the present time.

LIGHTING EQUIPMENT

LANDING AND TAXI LIGHTS

Two identical, non-adjustable, lights are mounted on the main landing gear strut and serve the dual purpose of landing and taxi lighting. The right hand light points straight ahead and the left hand light points slightly to the left to illuminate the edge of the runway. These lights may not be operated independently.

NOTE

Do not retract the gear with the landing lights ON nor operate the lights on the ground for longer than five minutes at any one time. Without proper cooling, the lights will burn out in a very short time.

LANDING AND TAXI LIGHTS SWITCH

The switch for operating the landing and taxi lights is located on the left console aft of the throttle and is labeled LANDING LTS.

COCKPIT LIGHTING

Warning Lights

Dual lamp, push-to-test warning lights are provided. The warning indications are engraved on the translucent light covers. The warning lights are all connected to the cockpit lights circuit breaker located on the cockpit circuit breaker panel. When the instrument lights rheostat is turned OFF the warning lights will be bright. Turning the instrument lights on dims all the warning lights except fire and landing gear.

Instrument Lights

The primary engine and flight instruments are lighted by small post type red lights. The instrument lights rheostat, located on the right side of the instrument panel next to the fuel pressure indicator, controls the in-

tensity of these lights. In the extreme counterclockwise or OFF position, the instrument lights are off and the warning lights are bright. The first clockwise motion of the rheostat dims all warning lights except fire landing gear, as well as turning the instrument lights on dim. Further clockwise rotation of the rheostat increases the instrument light intensity. Power for the instrument lights is from the cockpit lights circuit breaker. The equipment panels on the left and right consoles contain integral lighting which is wired to the cockpit lights circuit breaker. No intensity control is provided.

Panel Lights

The panel lights aid in locating and identifying switches, knobs, circuit breakers, counters, etc. Lighting is accomplished with the same kind of post type red lights as are used to illuminate the instruments. A rheostat with an OFF position controls the intensity of the panel lights. It is located directly beneath the cabin altimeter on the right vertical panel and is wired to the cockpit lights circuit breaker.

Utility Spot Lights

A utility red spot light is provided on each side of the cockpit for added illumination or map reading. Each of these lights contains an integral dimming rheostat and a spring coil type extension cord. Mounting sockets are underneath the left and right canopy sills. To avoid interference caused by these lights when not in use, they are stowed aft on the left and right console. Power is from the cockpit lights circuit breaker.

NAVIGATION AND ANTI-COLLISION LIGHTS

There are no navigation lights installed on the airplane.

Some aircraft are equipped with two Gimes Beacon Lights, one located on the top of the fuselage above the wing and the other located below the fuselage either below the wing or on the lower equipment bay hatch. Both red

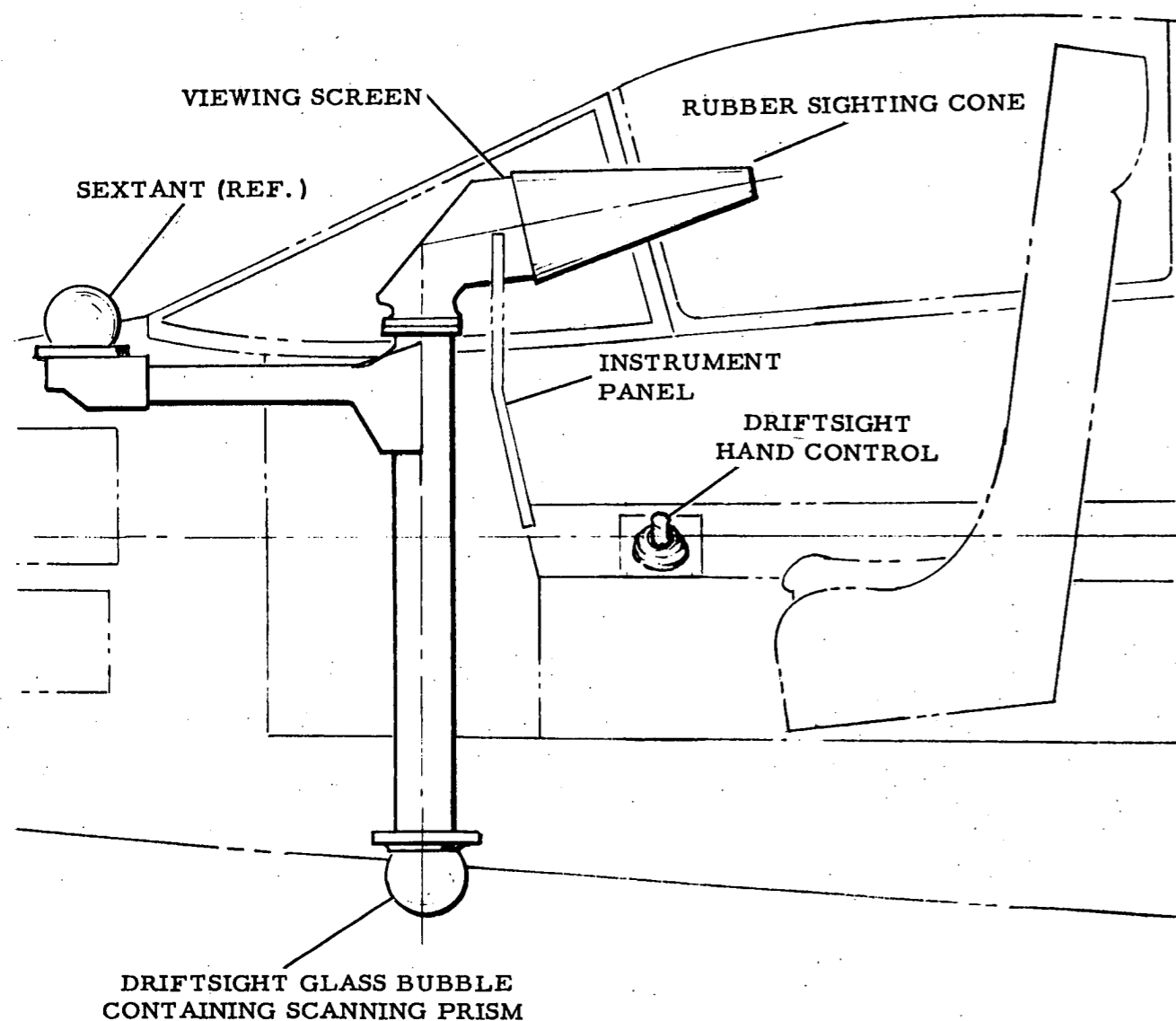

DRIFTSIGHT SYSTEM
FIG. 4-8

SECRET

beacons continuously rotate through 360° when energized.

On those aircraft not equipped with the beacons, landing lights should be used as an aid to location and identification.

NOTE

Use of the rotating beacon in clouds tends to induce vertigo.

NAVIGATION LIGHT SWITCH

An ON-OFF switch labeled NAVIGATION LTS is provided on the left console for operating the Gimes Beacon Lights. The circuit breaker for this equipment is located in the equipment bay. When external D-C ground power is on the aircraft the beacons will operate with the D-C power switch in either GEN-BAT or BAT only position. When no external D-C power is on the aircraft, the D-C power switch must be on the GEN-BAT position and the generator must be operating.

DRIFT SIGHT SYSTEM

GENERAL

A drift sight system, Figure 4-8, is normally provided in all aircraft. This equipment consists of an optical tracking system using a combination of mirrors and prisms to project a presentation of the local terrain on a scope in the cockpit. This information is used in pinpoint navigation.

The drift sight system is composed of a scope or viewing screen, a hand control panel, a periscope and a junction box. All of the present systems use the same viewing screen and the same basic periscope.

The system requires only 28v D-C from the aircraft electrical system.

VIEWING SCREEN (SCOPE)

The viewing screen is six inches in diameter and is equipped with a drift grid to simplify drift detection. It is located directly above the instrument panel. This is the same screen used in conjunction with the sextant. Below and to the right of the screen is a push-pull knob labeled SEXTANT PULL. For drift sight presentation, this knob is pushed in.

PERISCOPE

The tracking periscope is equipped with a dual prism scanning head. Two magnifications or powers are available; .4X and 1X. These are mechanically varied by an electrically controlled power changer attached to the optical tube. During the change in magnification the image is always in focus. Scanning in azimuth and elevation is accomplished by controlling a scanning prism at the objective end of the optical system. The scanning prism is located in an air purged glass bubble underneath the aircraft and just forward of the cockpit.

JUNCTION BOX

The junction box provides mechanical and/or electrical connection points for the various units of the system.

HAND CONTROL PANELS

There are three types of hand control panels presently in use with the drift sight. They are designated as the MARK I, II and III. The MARK I and II control panels are identical in appearance except for the number of mode switch positions. Figure 4-9 shows a MARK I panel.

MARK I

Controls

The control panel is equipped with a control handle, a track knob, a drift knob, a mode

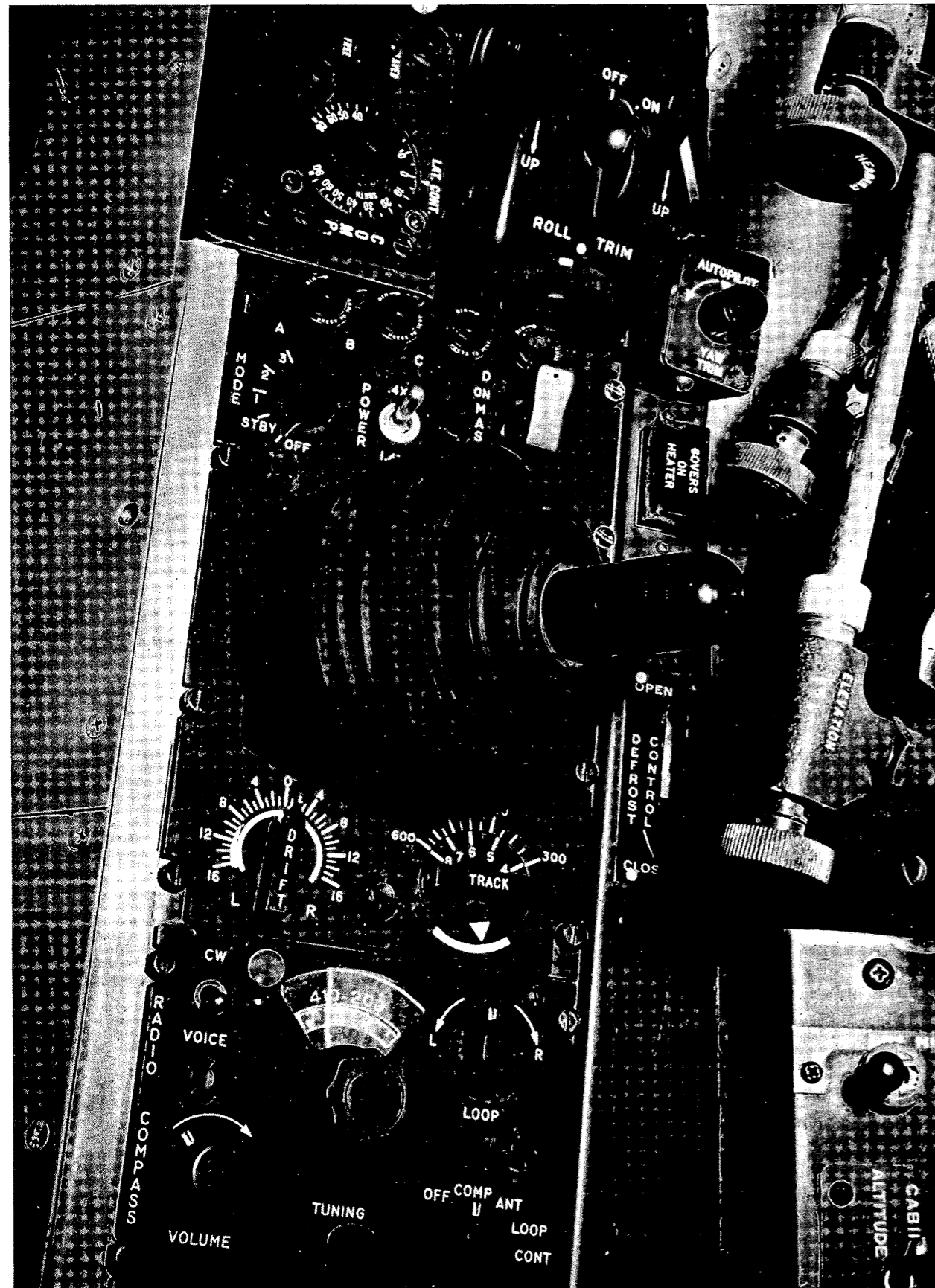

MARK I DRIFTSIGHT CONTROL PANEL

FIG. 4-9

SECRET

selector switch, a master switch, and a power changer switch. The control functions are as follows:

Control Handle - The control handle, located on the right console, provides a mechanical means of controlling the azimuth and elevation of the scanning prism. This handle operates in a full range from vertical to sixty degrees rearward and/or sixty degrees right or left. For simplicity, it could be imagined that the axis of the control handle corresponds to the line of sight available when viewing through the scope. This provides a view of the terrain from directly below, to sixty degrees either side or in front of the aircraft. When moving the handle from right to left (regardless of fore and aft position), a slight detent may be felt. This is to aid the observer in determining when he is looking straight down or straight ahead of the aircraft. This aid is only effective when the aircraft is in straight and level flight.

With the mode selector switch turned on, a clutch connecting the control handle to the automatic tracking drive is energized. When the handle is lightly depressed, the clutch is de-energized and the handle is free for manual scanning. The automatic tracking is provided by a motor-driven mechanism which synchronizes the elevation control of the scanning head to the approximate ground speed of the aircraft. It enables the operator to sight a target and then, by releasing the control handle, to automatically keep the target in view as the aircraft moves toward it.

Tracking Knob - The tracking correction knob permits an exact synchronization of the automatic tracking rate with the ground speed of the aircraft. It is marked in tens of thousands of feet altitude and the panel adjacent to it is marked in knots. To use this control, turn the knob until the estimated altitude above the terrain is opposite the estimated true ground speed. Sight on an object and release the control handle. If the object moves down the face of the viewer, the tracking knob should be turned clockwise until the vertical motion of the

object is stopped. At that time the tracking drive is synchronized to the true ground speed of the aircraft. Conversely, if the object moves upward, the tracking knob should be turned counterclockwise. An approximation of true ground speed can be obtained by reading the setting of the tracking knob when the movement of an object has been stopped on the face of the scope.

Drift Knob - To stop lateral movement of an object across the face of the scope, turn the drift knob until the lateral motion is stopped. At this time the drift angle (not the drift correction) in degrees can be read directly from the drift knob setting.

Mode Selector Switch - This is a five position switch labeled OFF, STBY, and MODE 1, 2, 3. The automatic tracking function of the hand control will operate when the selector switch is in any position except OFF. The operation of the mode positions and the function of the indicator lights are discussed in the photographic section.

Master Switch - When placed in the ON position, the master switch turns on the tracker camera and some of the various electronic intelligence systems. It also energizes the power changer switch.

Power Changer Switch - The optical power changer switch changes the magnification of the drift sight. The switch positions are labeled .4X and 1X. Placing the switch in these respective positions causes the scope presentation to be in a .4 to 1 ratio or a 1 to 1 ratio with respect to its unaided field of vision. The field of view for each lens position can be estimated by observing the square reticle in the drift sight presentation which is approximately one nautical mile on a side when viewed from operational altitudes. This reticle varies in size with the magnification so that it always represents one nautical mile on a side.

SECRET

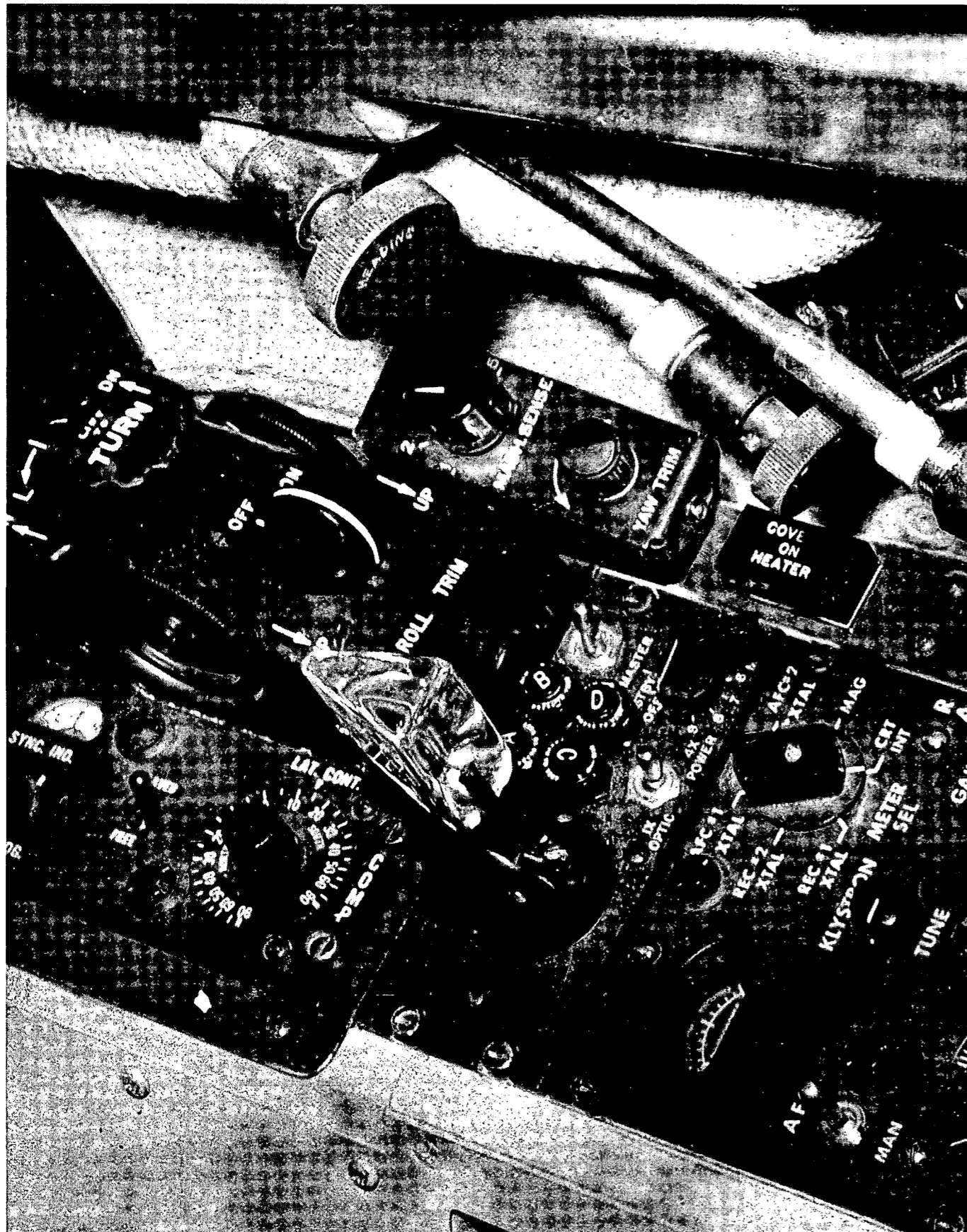

MARK III DRIFTSIGHT CONTROL PANEL

FIG. 4-10

~~SECRET~~

NOTE

A target store button is included on the drift sight control panel but it has no function for any equipment presently in the aircraft. It is not connected but may be used with future installations.

Operation - To operate the system, turn the master switch ON and set the mode selector switch to the scheduled position. Select the desired magnification on the power changer switch. Press the control handle down and move the handle to sight on a distant object. Locate the object in the center of the reticle square and release the handle. After a time interval (15-20 seconds), note any sidewise movement or drift. Quite likely the presentation will show both drift and tracking error when first set up. To correct for drift, rotate the drift grid on the scope until the grid lines parallel the apparent motion of the target. Read the scale by noting the exact reading (in degrees) of the index mark at the top of the scope. Turn the drift knob on the control panel to the exact setting indicated on the drift grid. Position a new target (or use the same one if time permits) in the center of the reticle square and release the control handle. Observe the target for a few moments. If the target moves in a vertical direction, the track knob should be adjusted. Continue spotting targets, making minor adjustments of the drift and track knobs as necessary.

MARK II

The MARK II hand control panel is almost identical to the MARK I. The main difference is that the scanning prism is electrically controlled instead of a direct mechanical connection as with the MARK I. On the MARK II unit, synchro signals from the control handle are fed through a transistorized amplifier to a servo repeater assembly attached to the scanning head. This controls the movement of the scanning prism.

Controls

The controls operate in exactly the same manner as on the MARK I panel, with two exceptions:

Master Switch - In addition to its normal functions, the master switch also provides power for the transistor amplifier and the servo repeater unit. Therefore, this switch must be in the ON position before any scanning may be accomplished.

Mode Selector Switch - This switch functions the same as on the MARK I panel except that a #4 MODE position has been added for use with various equipment bay configurations.

Operation - The operation is the same as for the MARK I control panel.

MARK III

The MARK III hand control panel, Figure 4-10, is much smaller than the MARK I or II. The reason for this is that the automatic tracking function and its accompanying controls have been deleted from this unit.

Controls

The control panel is equipped with a control handle, a master switch, a mode selector switch, and a power changer switch. The control functions are as follows:

Control Handle - The control handle is smaller than on the MARK I or II and has a decorative prism installed on it. It is unique in that it can scan a full 360° in azimuth, and elevate to an almost horizontal position, providing complete coverage under the aircraft from horizon to horizon. The detent feature of the MARK I and II controls is retained in this unit. The control of the scanning prism is purely

mechanical and no electrical power is needed for the scanning operation.

Master Switch - As on the MARK I panel, when the master switch is placed in the ON position, it turns on the tracker camera, the electronic intelligence systems, and energizes the power changer switch.

Mode Selector Switch - This is an eleven position switch labeled OFF, STBY, and MODE 1, 2, 3, 4, 5, 6, 7, 8, 9. The number of MODE positions was increased to give added flexibility to equipment bay configurations.

Power Changer Switch - The function of this switch remains unchanged.

Operation - The operation of this drift sight is relatively simple since there is no automatic tracking function. It is only necessary to select the desired magnification with the power changer switch and then scan using the control handle. It is possible to estimate drift by observing a fixed object on the terrain, but no ground speed estimate is possible.

SEXTANT SYSTEM

GENERAL

The sextant is a conventional bubble type sextant which is mounted rigidly to the aircraft, just forward of the windshield. The sextant optical system uses a portion of the drift sight optics, and throws its measuring presentation on the face of the drift sight display. The sextant can be adjusted from -4° to 90° in elevation, and 360° in heading to give complete coverage of the heavens, except for that part near 180° heading which is blacked out by the windshield and canopy. The optical system of the sextant is a unit-power telescope with a field of view of 15° . This wide field simplifies location and identification of celestial bodies. The elevation

prism is located inside a 5" diameter protective glass dome which projects through the skin of the aircraft; this prism is mounted on a horizontal rotary platform so as to provide completely separate adjustments for elevation and heading. This part of the sextant is located in an unpressurized portion of the aircraft, and is completely sealed with respect to ambient air. Information from the sextant is projected optically through the forward pressure bulkhead into the cockpit through a pressure tight bulkhead coupling. The construction is such that in case of a broken glass dome or other break in the sealing of the sextant head there will be no loss of cabin pressurization. The part of the sextant inside the cockpit between the pressure wall and the drift sight is open to the interior of the drift sight, but sealed from cabin air to prevent entry of dust and dirt.

A ball and disc type integrator is located on the right side of the cockpit near the other sextant controls and allows the operator to average a sight over an observation period of up to two minutes. The sextant presentation is introduced into the drift sight presentation by means of a mirror which can be slipped into the optical path of the drift sight. All motions and controls are purely mechanical, and there are no motors or electronic elements. The presentation is illuminated by aircraft type miniature light bulbs operated from 28V D-C.

CONTROLS

The controls for the sextant consist of the following:

Sextant Pull Knob

This knob, located to the right of the scope, pulls out about 2" and rotates a 45° mirror into the drift sight optics, thereby throwing the sextant presentation into the drift sight. During night operation this knob should be pulled out so as to prevent the landing lights from causing undesirable glare through the drift sight.

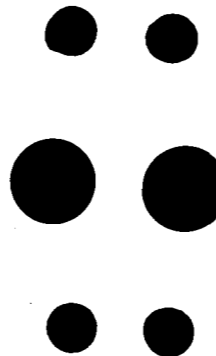

Sextant Filter Pull Knob

This knob, located to the left of the scope, pulls out about 2" and inserts a sun filter into the sextant optics. In daytime operation this knob should be left pulled out. If the sextant is pointed at the sun and the operator looks through the sextant he may be temporarily blinded by the glare without the sun filter.

Day-Dim-Night Switch

This three position switch, located on the right vertical console, controls the lighting of the sextant presentation. The DAY position is with the switch up, and this position is used for all daytime operation. The NIGHT position is with the switch down, and is used for taking night readings. The DIM position is with the switch centered, and under this condition only the bubble is illuminated. This position is used in centering a star and tracking it during the integration period.

Heading Twist Knob

This knob, located below the right canopy sill, adjusts the heading of the sextant with respect to the aircraft. It is capable of continuous rotation in either direction and adjusts the heading approximately 10° per turn.

Azimuth (AZ-HD) Twist Knob

The AZ-HD knob, located below the right canopy sill, allows the true azimuth of a celestial body to be set into the sextant. It is capable of continuous rotation in either direction, and adjusts azimuth approximately 20° per turn. As this knob is turned, it first engages a clutch through which the azimuth

CAUTION

Exercise care in operating pull knob as abrupt movements are apt to damage mirror mounting.

dial is driven. After an adjustment is made, this knob should be turned back approximately 45° to make sure the clutch has been disengaged. There is a "dead" band of approximately 90° when the clutch is disengaged.

Elevation Twist Knob

This knob, located below the right canopy sill, adjusts the elevation setting of the sextant, and also drives the averager. It can be rotated in either direction, and one turn adjusts the elevation by 5° . There are mechanical stops built into the sextant which stop this knob at approximately -4° and $+91^{\circ}$.

Averager Wind Lever

This lever, located on the averager, pulls out and forward approximately 1" and simultaneously winds and resets the averager. It has a spring return so that upon release it returns to its original position. It winds the clock mechanism in the averager to approximately 3 seconds below zero, and after release of the lever the counter runs and stops automatically at zero.

Averager Start Lever

This lever, located just below and forward of the elevation twist knob, swings down approximately $1/2$ " to start or stop the averager. It has an automatic spring return.

PRESENTATION

The presentation appears in the drift sight as shown in Figure 4-11. The counter reads elevation angle directly in degrees and minutes. For angles below zero it reads 99° , 98 and 97° , etc. for decreasing angles. There can be no confusion with high angles, as the lower stop is set at approximately 96° (-4°) and the upper stop at slightly over 90° . The heading is read by the setting of the bearing dial with respect to the lubber's line, and the azimuth is the setting of the arrow on the cursor with respect to the bearing dial. The cursor has the form of a cross with an open

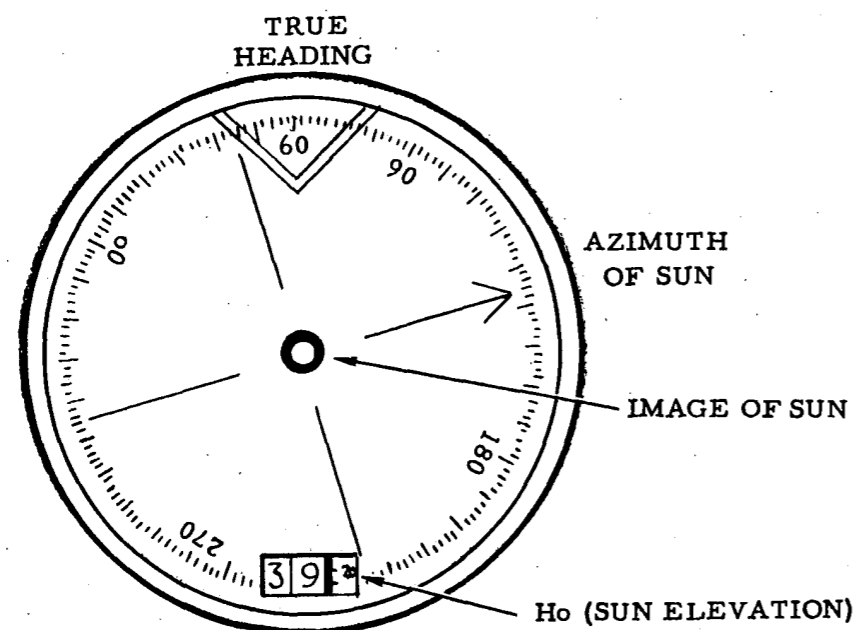
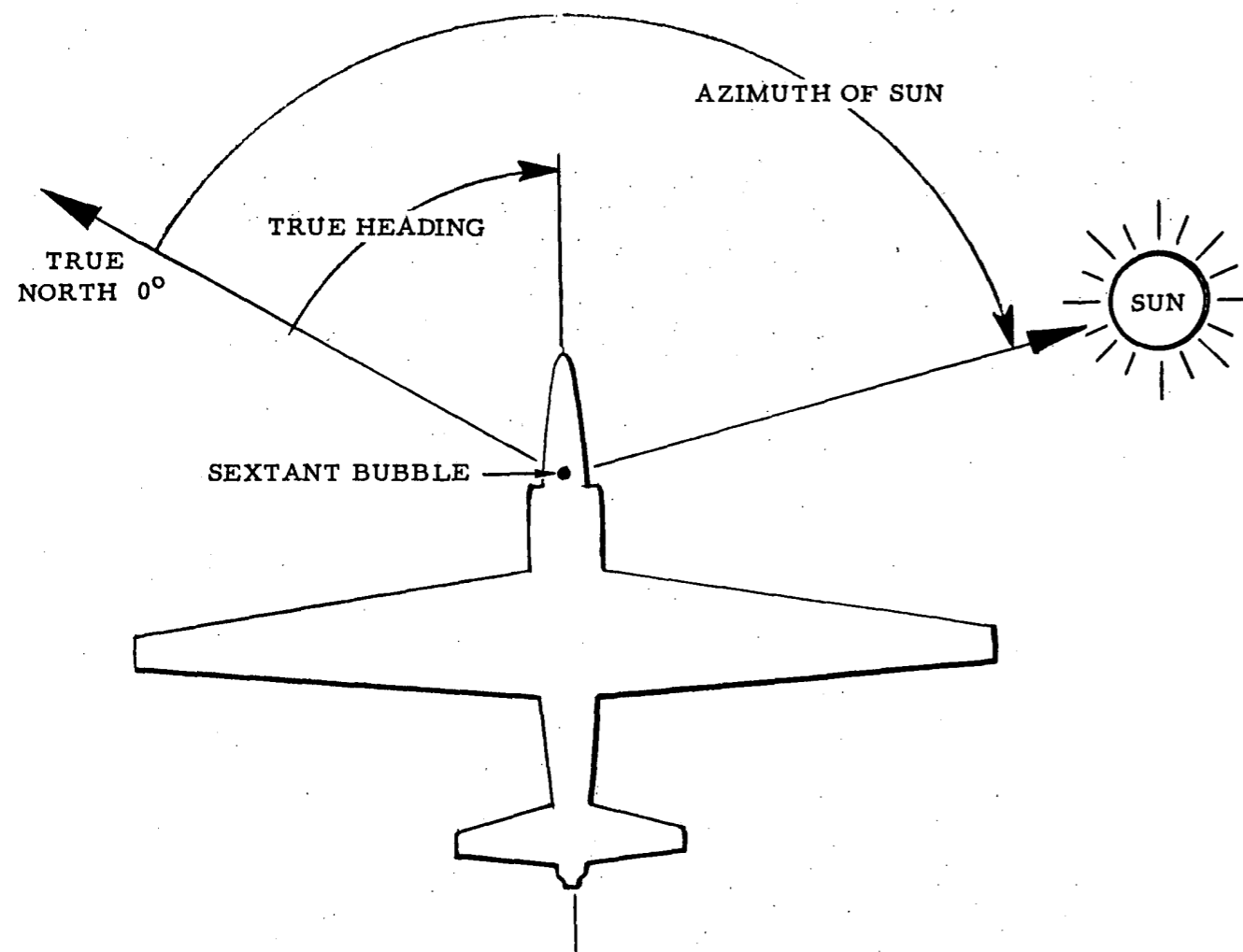

SEXTANT PRESENTATION

FIG. 4-11

SECRET

center. Movement of the elevation knob will move a target up and down parallel with the arrow on the cursor regardless of heading, and movement of the heading knob will move a target parallel to the cross bar of the cursor. The bubble appears as an illuminated ring near the center of the field of view. Since the bubble is projected optically into the field of view, it will not hide targets, and they can be seen clearly inside the bubble. The lighting intensity is controlled by the DAY-DIM-NIGHT switch as previously explained.

A rubber cone which slides onto the end of the drift sight viewing head is a supplementary item for daytime use of the scope. When removed from the scope head, it is normally stowed in the map case on the left side of the cockpit. The small opening at the end of the cone permits a full view of the presentation, and excludes a maximum of stray light. Proper eye position is about 3" behind the end of the cone piece.

AVERAGER

The averager is located above the right console directly behind the elevation twist knob. The averager contains a clock mechanism and a ball integrator which effects a continuous moving average over any observation period from 30 seconds to two minutes. The averager is wound and reset by the wind lever. No other presetting of the sextant, timing mechanism or averager is required. Because it continuously integrates altitude against elapsed time, it may be stopped at any time after 30 seconds by depressing the start lever without disturbing its operation. However, it is desirable to use the full two minutes observation period if possible. The average altitude angle is obtained at the end of an observation by recentering the average indice by means of the elevation twist knob. These indices can be observed by looking into the stainless steel mirror on the averager. When the indices are lined up, the counter in the presentation reads the average altitude directly. The time dial graduated in seconds indicates the half time of the observation, which indication may be added directly to the time of start to give the mean time of the

average altitude. When an integration time of less than two minutes is used, care should be taken in reading this time dial as it is viewed through a mirror and the numbers are mirror-image.

OPERATION

Locating a Body

In order to locate a celestial body, its approximate altitude and azimuth should be known. The first step is to pull out the sextant pull knob so as to introduce the sextant presentation into the drift sight optical system.

NOTE

For a daytime observation the sextant filter pull knob should first be pulled out so as to be sure that the pilot will not be blinded if the sun is in the field of view.

The elevation twist knob should now be turned so that the counter at the bottom of the field reads the proper precomputed angle of altitude (H_c). The AZ-HD knob should now be turned to the left (toward AZ) locking the bearing dial in position so that the true azimuth of the celestial body may be set in. True azimuth is set in by turning the heading knob until the cursor arrow points to the proper reading on the bearing dial. The AZ-HD knob should now be turned to the right (toward HD). This now locks the bearing dial to the cursor so that when the heading knob is turned again the dial and cursor will rotate together. The estimated true heading of the aircraft is now set in by turning the heading twist knob so that the proper angle on the bearing dial appears under the lubber's line at the top of the presentation. At the precomputed time, if all adjustments have been made correctly, the celestial body should appear well within the 15° field of view.

After the body has been located, it should be centered in the bubble. Rotation of the elevation twist knob will move the object along

the direction of the arrow on the cursor, and rotation of the heading twist knob will move the object at right angles to this arrow. In the case of night use, the initial adjustments should be made with the DAY-DIM-NIGHT switch in the NIGHT position, then the final adjustments should be made with the switch in the DIM position with only the bubble illuminated.

Elevation Readings

After the sextant has been adjusted and the celestial object is in the field of view, it is necessary to center the object inside the bubble by using the elevation and heading twist knobs. It is not necessary for the bubble to be in the center of the field to take a reading, as the bubble and the image of the object will move together in the plane of the sextant elevation. However, if the bubble is far off it may indicate that the aircraft is not on a straight and level course, and to obtain accurate readings it is important that the aircraft be operated as straight and level as possible. Spot readings may be taken, but they will be subject to more error than those taken with the averager. The counter in the presentation reads the altitude directly and no corrections are required. The exact time of the shot must be noted as well as the altitude.

Use of Averager

In preparing to take a shot using the averager, first operate the wind lever on the averager and make sure the timing disc runs a few seconds and stops at zero. Then locate the celestial body as previously described. After the body is centered in the bubble, note and record the exact time and push the start lever on the averager. For the next two minutes, adjust continuously both the elevation and heading twist knobs to keep the object centered in the bubble. After two minutes have elapsed, turn the elevation twist knob so as to re-center the averager indices, and read the averaged altitude directly from the counter. If the full two minute period has been used, add one minute to the starting time to obtain the correct time for the averaged

reading. If the averager has been stopped before the end of the two minute period, add half the number of seconds indicated in the presentation to the starting time. No error will be introduced if the object is tracked more than two minutes, as the averager clock work has been shut off automatically, and no averaging takes place after the two minutes regardless of motions of the elevation twist knob.

Heading Readings

True heading readings may be obtained by setting in pre-computed azimuth, heading, and altitude information as previously described. After the chosen celestial body has been located and centered in the bubble, at the pre-computed time the true heading can be read directly from the lubber's line and the bearing dial. The accuracy of this reading will depend upon the accuracy of the time measurement and the assumed position used in the pre-computations. It will also depend on the altitude of the celestial object. Therefore, it is desirable to select celestial bodies at least 30° away from the zenith.

Daytime Check List

1. Place rubber cone onto drift sight head.
2. Pull out the sextant filter pull knob which places a light filter in the optical system to permit looking directly at the sun.
3. Pull out the sextant pull knob. This lowers a mirror into the drift sight barrel and places the sextant presentation on the drift sight.
4. Place the DAY-DIM-NIGHT switch in the DAY position.
5. Set in azimuth of the sun (Zm from pre-comp sheet) by turning azimuth knob to left and by turning heading knob until scale reads Zm against cursor arrow.
6. Set in approximately one true heading from compass (correcting to

approximately true) by turning azimuth knob to right and by turning heading knob until scale shows approximately true heading up against lubber pointer.

7. Set in computed elevation of the sun (Hc from precomp sheet) by turning elevation knob until the counter reads Hc.
8. The sun should now appear in field of view. Center sun in bubble by adjusting heading and elevation knobs. Field of view is about 15° across.
9. Use averager as required.
10. Read true heading indicated on scale.
11. Read elevation of the sun Ho on counter.
12. Ho-Hc = intercept.

Night Check List

1. Push in sextant filter pull knob.
2. Pull out sextant pull knob.
3. Throw toggle switch to NIGHT.
4. Set in pre-computed data, search for star in field of view, proceed as with daytime operation.
5. If star is not located, throw toggle switch to DIM, then search the field and center star in bubble.
6. Use the averager as required.
7. Throw switch back to NIGHT, read true heading and Ho.

WINDOW COVER JETTISON SYSTEM

GENERAL

The camera windows located in the equipment bay lower hatch are made of precision ground

glass. The condition of these windows is very important to the success of the mission. The outside surface of the windows is protected from dirt, rocks and moisture by disposable metal covers which are held in place by movable hooks. These covers also serve as insulators to help prevent moisture formation on the inside surfaces.

The jettison system is composed of a small 1500 psi nitrogen storage bottle, pressure regulator and solenoid valve. The high pressure is regulated to 55 psi and admitted through the solenoid valve to a series of small operating cylinders. Admission of pressure to the cylinders overcomes a spring and opens the forward hooks on each cover allowing it to be blown from the window.

CONTROLS

The operating solenoid is controlled by a guarded momentary switch located on the right aft console.

The red indicating light is located on the right console and glows when any cover remains in place.

NOTE

This is a dual function light which also glows when the hatch heater is turned on. To check the window covers, the hatch heater must be turned off.

OPERATION

The covers can be retained through the early climb until cruise altitude is reached. This will aid in preventing frost or moisture formation on the inside of the windows. To jettison covers, actuate the switch momentarily. Check the warning light to be out. If the light stays on, repeat the procedure.

CAMERA CONFIGURATION CHARACTERISTICS									
CONF. G.	FOCAL LENGTH	RANGE PHOTO FLT. LINE MI.	AREA COVERAGE (Vert. Photo)	GROUND RESOLUTION (Vert. Photo)	GROUND SCALE	OPERATING TIME	CYCLE TIME	MODES OF OPERATION	INDICATOR LIGHTS
A-1	THREE FIXED 6"	5000 STEREO	20 X 20 MILES	18 FT.	1:140,000	8 HOURS	60 SEC.	#1 TRIPLE FAN ROCKER PLUS TRI CAMERA #2 ROCKER FIXED VERT. PLUS TRI CAMERA #3 TRI CAMERA ONLY #4 CONFIG. STOPS	ABC & D ABC & D AB & C NONE
	ONE ROCKER 24"	2080 STEREO	5 X 10 MILES	4 FT.	1:35,000	MODE 1 1:36 MODE 2 4:49	MODE 1 5 SEC. MODE 1 15 SEC.	#1 THREE CAMERAS SIMULTANEOUS #2 -3 NOT USED #4 CONFIG. STOPS	AB & C NONE
A-2	THREE FIXED 24"	3250 STEREO	5 X 10 MILES	4 FT.	1:35,000	4:49	15 SEC.	#1 SEVEN POSITION SWEEP (High to High) THREE POSITION STEREO	D
B	ONE ROCKER 36"	SWEEP 1700 STEREO	6.5 X 6.5 MILES	2.5 FT.	1:23,300	MODES 2, 3 & 4 8 HOURS	MODES 2, 3 & 4 7.6 SEC.	#2 THREE POSITION FAN (Right-Vert. -Left) THREE POSITION STEREO	B & D
		FAN 2800 STEREO						#3 THREE POSITION FAN (Lo-Med-High Oblique)	C & D
								#4 THREE POSITION FAN (Lo-Med-High Oblique)	A & D

FIG. 4-12

SECRET

HATCH WINDOW HEATER SYSTEM

GENERAL

Under high humidity atmospheric conditions, moisture can be deposited on the cold inner surface of the windows. In order to prevent this and keep the windows as clear as possible a heater-blower system is installed in the lower hatch. A small blower with a 1000 watt heater attached is ducted to each window so that the warm air flows directly across the inner surface.

CONTROLS

The blower is so connected that it is always running for normal flight. There is no control from the cockpit. However, in case of generator failure the blower will be disconnected and cannot drain the battery. The heater switch is located on the right aft console. This is a two position switch for heater ON or OFF.

OPERATION

In order to obtain maximum benefit from the heater-blower system, the heater should be turned ON after take-off. It should remain ON until the time when the cameras are operated. In extreme cases the heater could be left on for the entire mission.

PHOTOGRAPHIC EQUIPMENT

GENERAL

The primary payload of the airplane consists of various camera configurations. These different groupings are designated as A-1, A-2 and B. Any one of these may be installed in the equipment bay aft of the cockpit, depending on the type of mission. The characteristics chart, Figure 4-12 provides data for each of the different configurations.

Two types of lower equipment bay hatches are provided with proper window locations and sizes for the corresponding camera

configuration. A tracker camera is mounted in the aft end of each hatch. It records the terrain from horizon to horizon and is used to document the complete flight path of a mission.

TRACKER CAMERA

The tracker camera, shown in Figure 4-13, carries 1000 feet of 70 MM film and has a 3 inch focal length. It makes a sweeping exposure from horizon to horizon with an average interval of 32 seconds and an average scan time of 1/2 second. The duration is approximately 10 hours. This camera is in operation whenever the master switch on the drift sight control panel is in the ON position.

A-1 CONFIGURATION

This configuration is composed of four cameras which are installed on a single mount as shown in Figure 4-14. On the aft end of the mount is a tri-camera installation consisting of three cartographic cameras having six inch focal lengths and 9 x 9 inch negatives. One of these cameras is oriented vertically, one is left oblique, and the other right oblique. At maximum altitude the vertical camera makes an exposure covering an area of 20 x 20 miles.

The fourth camera is in a rocking mount at the forward end of the installation. It has a 24 inch focal length and a 9 x 18 inch negative. This camera automatically rocks into the right oblique, vertical, and left oblique positions. At maximum altitude a vertical exposure covers an area of 5 x 10 miles.

The rocking mount camera has image motion compensation, commonly known as IMC. The forward side of this mount is lowered during exposure, which compensates for the forward motion of the airplane. The IMC movement of the camera is accomplished by an electric motor drive to which the shutter is synchronized.

A-2 CONFIGURATION

This configuration is composed of three

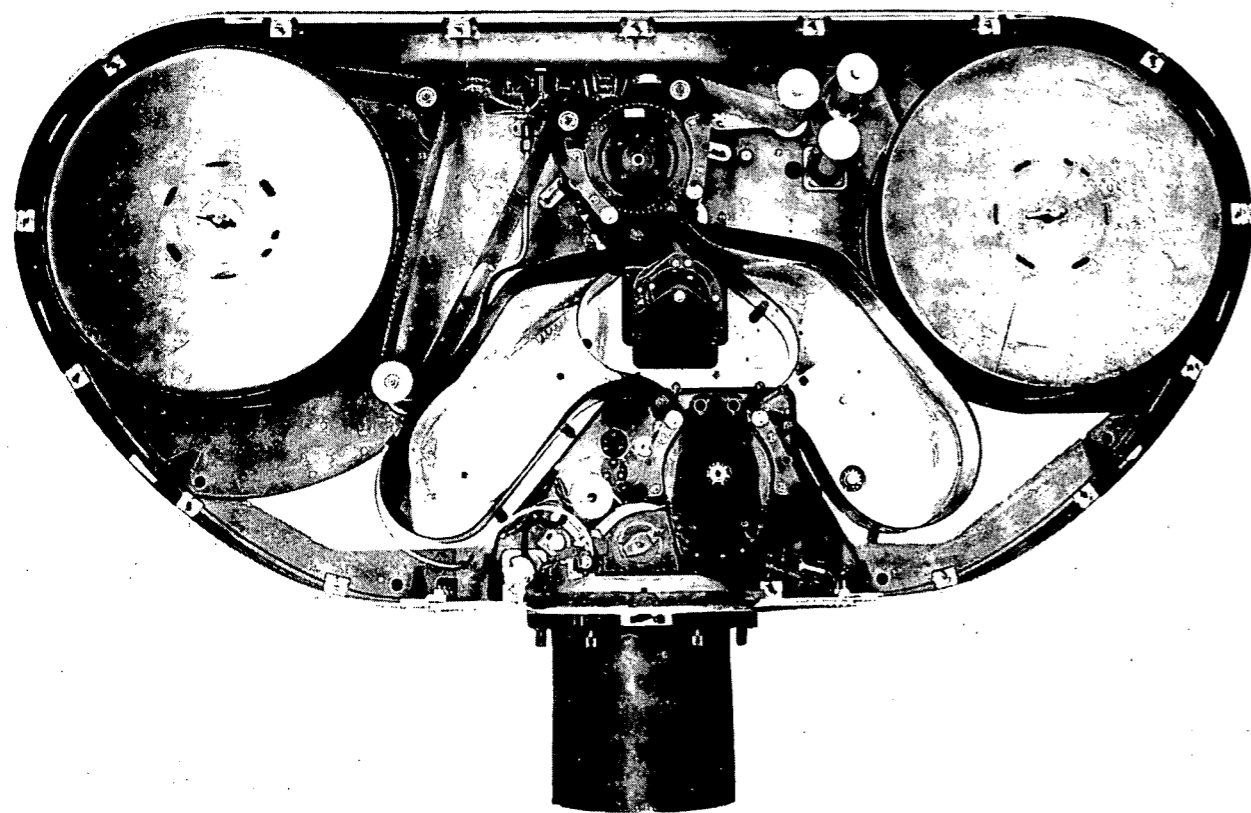

TRACKER CAMERA

SPECIFICATIONS

FILM - 70 MM X 1,000 FT.
 FORMAT - 2 3/8" X 9 1/2"
 LENS - 3" FOCAL LENGTH f 8.0
 TOTAL WEIGHT WITH FILM - 58 LB.

FIG. 4-13

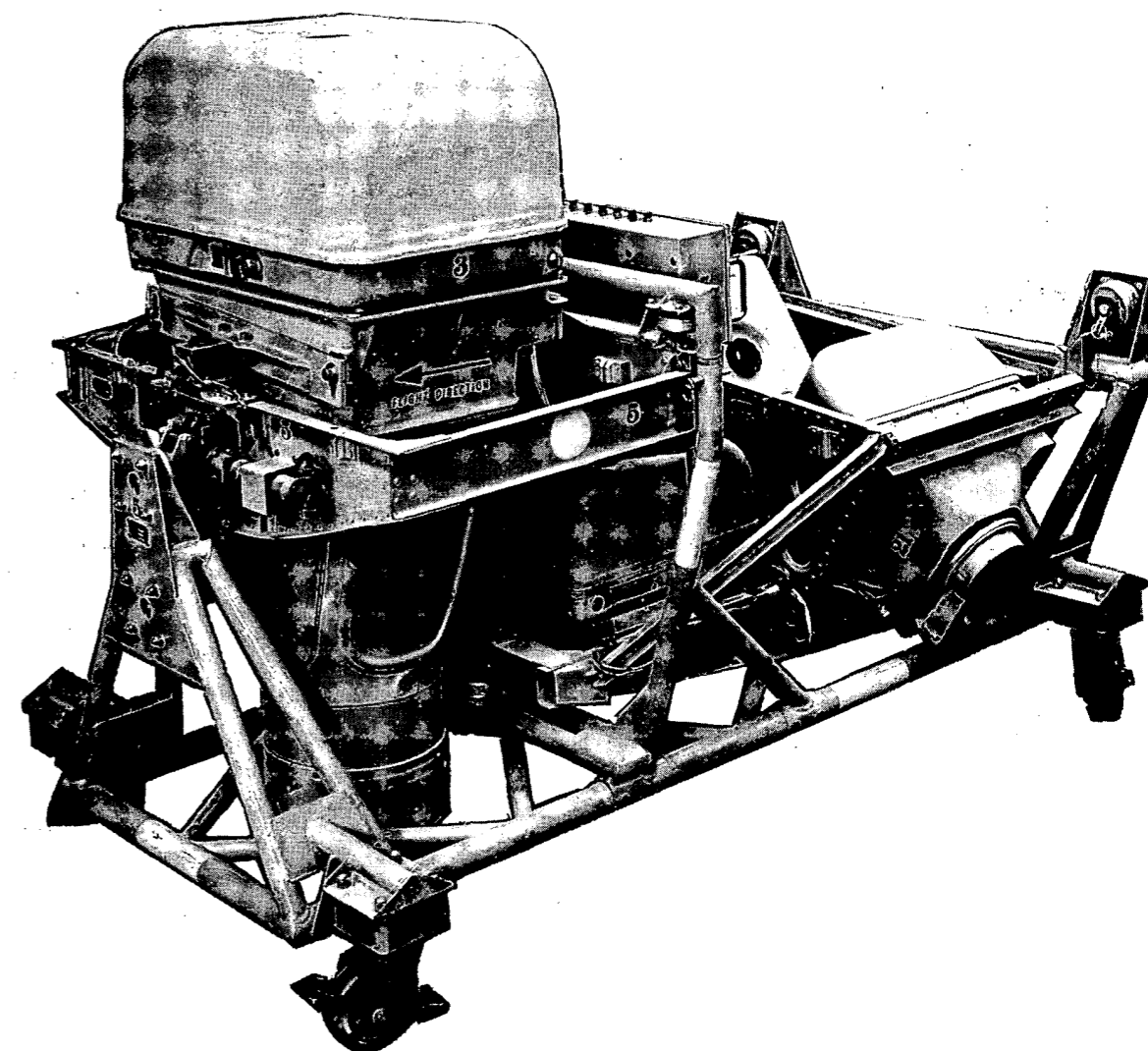
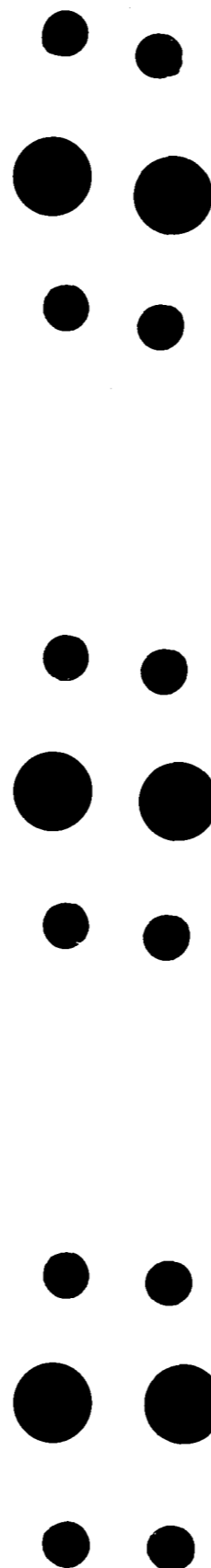
~~SECRET~~A₁ CONFIGURATIONSPECIFICATIONS

CAMERAS - (3) HC 730 AND (1) HR 731
 FILM - 9 1/2" X 390 FT. AND 9 1/2" X 1800 FT.
 LENS - 6" FOCAL LENGTH (f 16.3) AND 29" FOCAL LENGTH (f 6.0)
 SHUTTER SPEED - 1/150 AND 1/300 SEC.
 TOTAL WEIGHT WITH FILM - 349 LB.

FIG. 4-14

~~SECRET~~

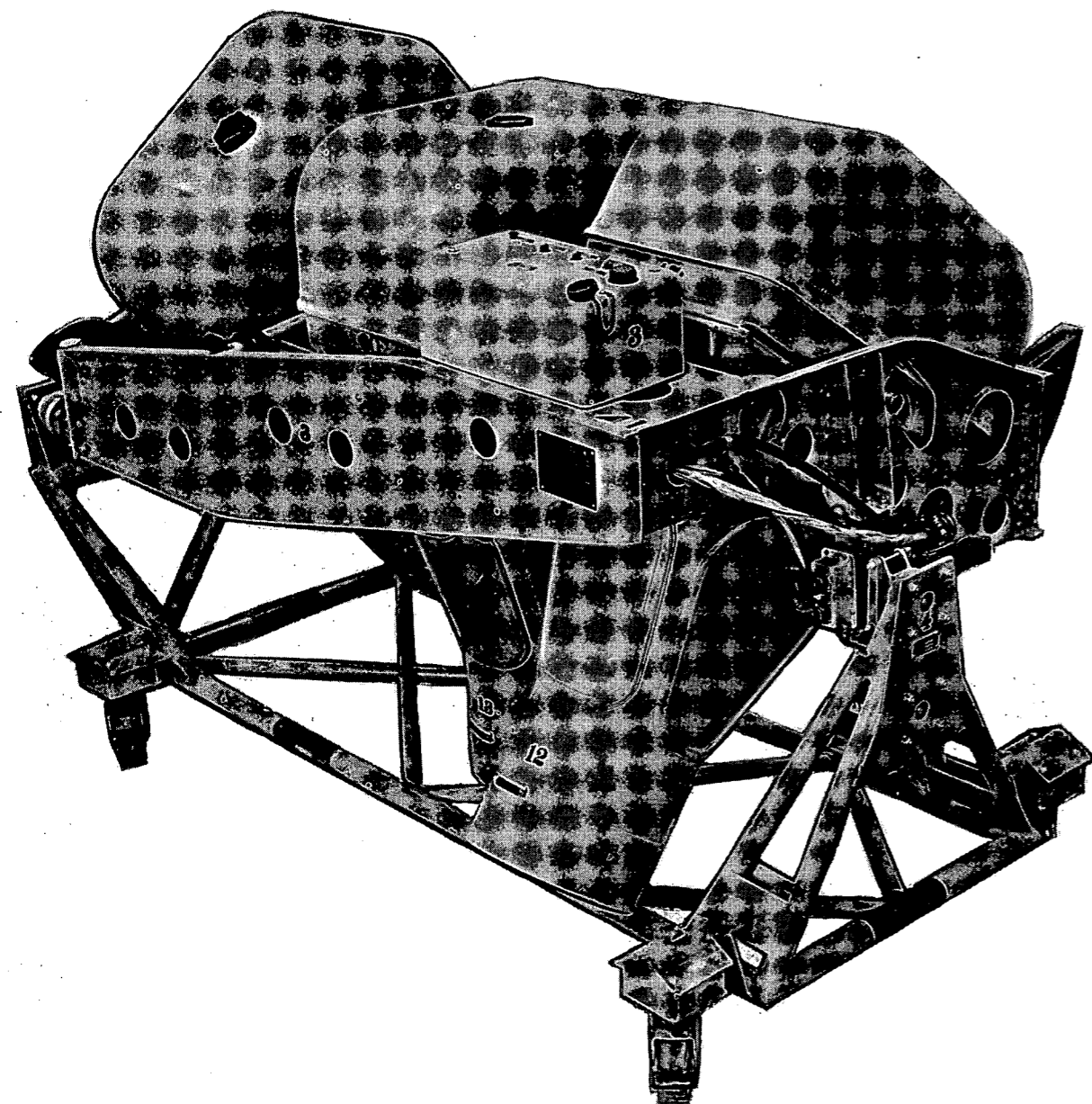
A₂ CONFIGURATIONSPECIFICATIONS

CAMERAS - (3) HR 731
 FILM - 9 1/2" X 1800 FT.
 FORMAT - 9" X 18"
 LENS - 24" FOCAL LENGTH (f6.0)
 SHUTTER SPEED - 1/150 SEC. AT f16.
 TOTAL WEIGHT WITH FILM - 361 LB.

FIG. 4-15

SECRET

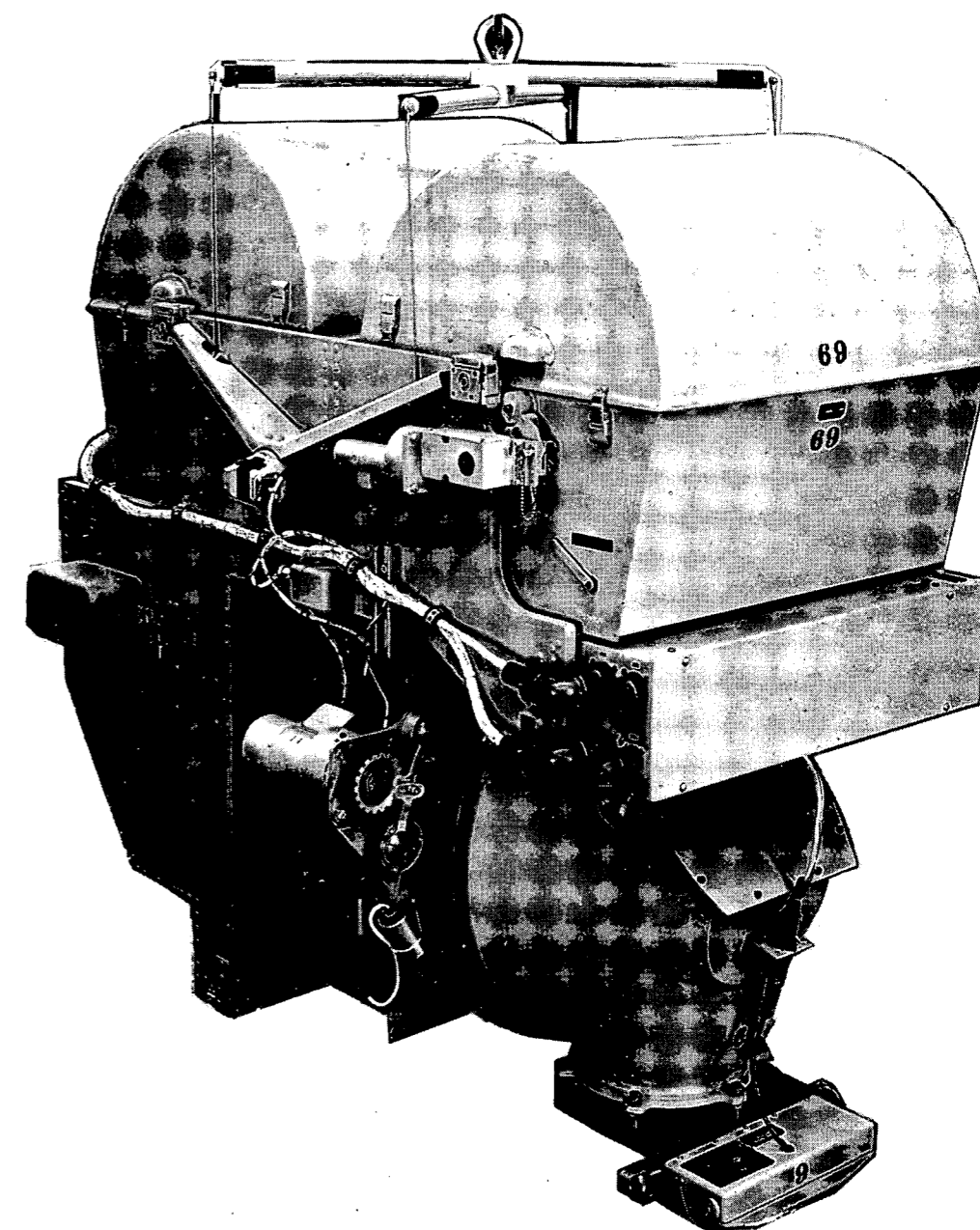
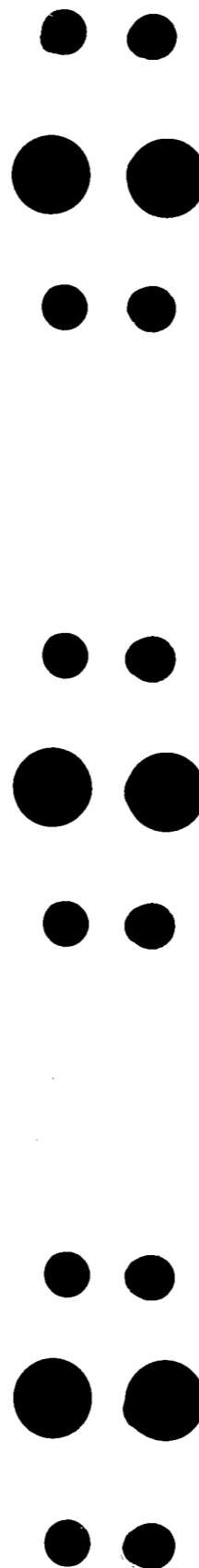

B CONFIGURATION

SPECIFICATIONS

CAMERA - 73 B
 FILM - 2 ROLLS 9 1/2" X 4000 - 6000 FT.
 FORMAT - 18" X 18"
 LENS - 36" FOCAL LENGTH f-10 PENTAC
 SHUTTER SPEED - 1/150 AND 1/300 SEC.
 TOTAL WEIGHT WITH FILM - 4000 FT. @ 417 LB.,
 6000 FT. @ 489 LB.

FIG. 4-16

SECRET

identical cameras which are installed in a single mount as shown in Figure 4-15. These cameras have a 24 inch focal length and a 9 x 18 inch negative.

Image motion compensation is also provided for this configuration.

B CONFIGURATION

The B configuration is an automatic 36 inch focal length, high altitude reconnaissance camera system. It consists of one camera weighing approximately 420 pounds as shown in Figure 4-16. It has one fold in the optical system to accommodate the longer focal length.

The basic format size is 18 x 18 inches and is composed of two strips of 9 1/2 inch film exposed side by side. These film strips are transported in opposite directions to maintain the same C. G. location for the unit during operation. The maximum film load for this camera is two 6000 foot rolls of film (B overload). From operating altitude, a vertical photograph gives a coverage of 6.5 x 6.5 miles.

There are seven basic positions from which this camera can take exposures; three right oblique, one vertical, and three left oblique.

This configuration is equipped with IMC.

CONTROLS

The photographic equipment controls and indicating lights are located on the drift sight control panel.

Master Switch

This two position guarded switch performs the following functions:

1. Turns the tracker camera on and off.
2. Turns systems I, III and IV on and off.
3. Provides power for operation of the

power changer switch on the drift sight control panel.

Mode Selection Switch

This rotary selector has five positions:

1. OFF.
2. STBY. This is the standby position. It provides power for completing the cycling operation in all configurations before complete shut down. It also energizes the automatic tracking function of the drift sight, as well as turning on the MARK II drift sight inverter.
3. MODE 1, 2, 3 and 4. Selection of one of these positions provides control of the various modes of operation of the cameras depending upon the configuration involved. The drift sight automatic tracking functions and the MARK II drift sight inverter continue to be powered.

INDICATOR LIGHTS

There are four indicator lights located on the drift sight hand control panel which indicate camera operation as follows:

A-1 Configuration

- light A - Left oblique (L4)
- light B - Vertical (V3)
- light C - Right oblique (R2)
- light D - Rocking camera (5R)

A-2 Configuration

- light A - Left oblique (L8)
- light B - Vertical (V7)
- light C - Right oblique (R6)
- light D - Not used

B Configuration

- light D - MODE 1 - All seven positions.
- lights B and D - MODE 2 - One left oblique, one vertical and one right oblique.
- lights C and D - MODE 3 - Three right obliques
- lights A and D - MODE 4 - Three left obliques

OPERATING MODES

The various methods of operating each configuration are discussed below, and the corresponding mode selector switch position is given.

A-1 Configuration

The three fixed cameras take an exposure every sixty seconds when operating on MODE 1, 2 or 3. A full film load has an eight hour duration. The rocking camera operates as follows:

- Mode 1- Completes a sequence of three exposures every fifteen seconds. The film duration is one hour and thirty-six minutes.
- Mode 2-Does not rock. Takes one exposure in vertical position every fifteen seconds. The film duration is four hours and forty-nine minutes.
- Mode 3 -Does not operate.

A-2 Configuration

- Mode 1 - The three fixed cameras take an exposure every fifteen seconds. Operating time with a full load is four hours and forty-nine minutes.

Mode 2 - Not used.

Mode 3 - Not used.

B Configuration

- Mode 1 - The camera sweeps continuously from horizon to horizon making exposures at all seven positions. Operating time with full load of 6000 feet is 5 hours.
- Mode 2 - The camera operates in a vertical fan taking three pictures at low left oblique, vertical, and low right oblique positions.
- Mode 3 - The camera operates in a right fan taking pictures in the three right oblique positions.
- Mode 4 - The camera operates in a left fan taking pictures in the three left oblique positions.

Film duration with a full load is over eight hours in MODES 2, 3 and 4.

OPERATION

A-1 and A-2 Configurations

1. Turn hatch heater switch ON at takeoff.
2. Turn master switch ON. This is usually done soon after takeoff to obtain a full record with the tracker camera.
3. Turn the jettison covers switch ON after reaching cruise altitude.
4. Turn hatch heater switch OFF before operating cameras.
5. Set mode selector switch to desired mode before reaching target area. (Only MODE 1 is used with the A-2 configuration.)

NOTES

1. It may take up to sixty seconds for the A, B and C lights to come on with the A-1 configuration, and up to fifteen seconds with the A-2 configuration. The D light, which is used with the A-1

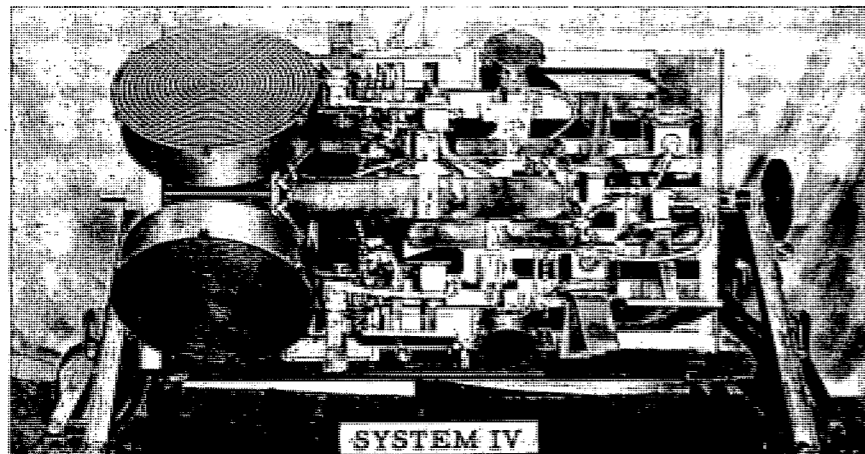
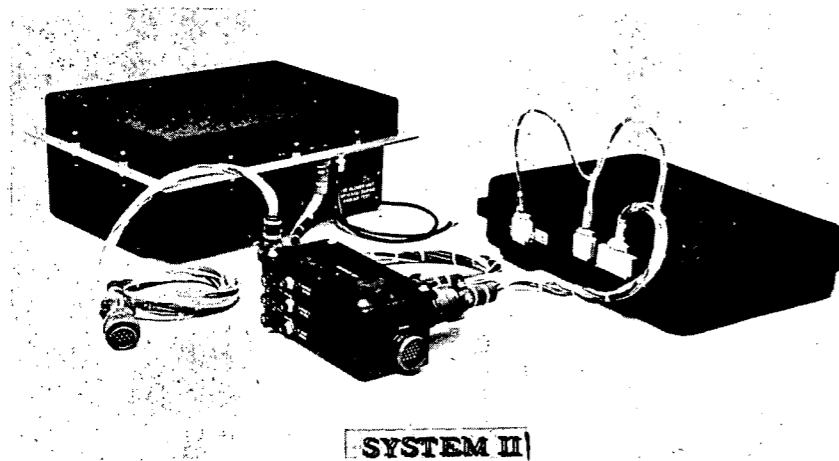
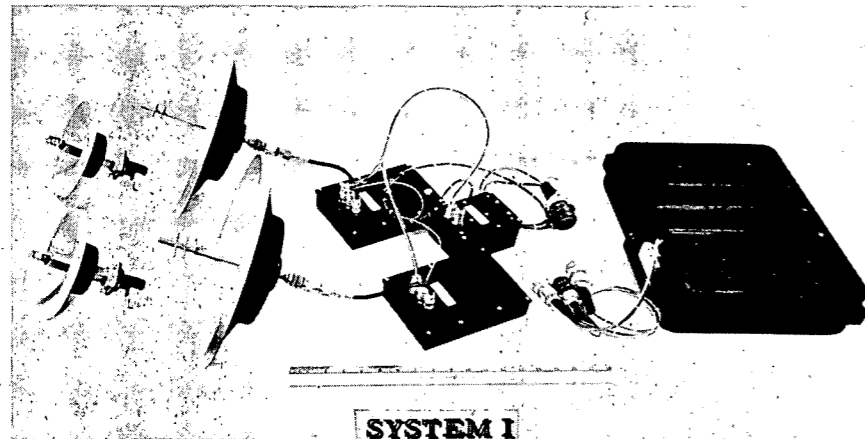

ELECTRONIC INTELLIGENCE SYSTEMS

FIG. 4-17

SECRET

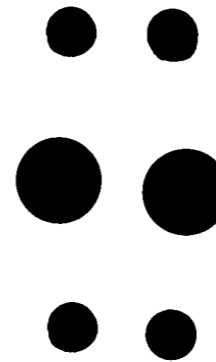

configuration only, will come on almost immediately.

2. If some of the indicator lights go out during normal operation, indicating camera malfunctions, the mission may be continued with the remaining cameras.
6. Upon completion of mission, turn mode selector switch to STBY until all indicator lights are out. Then selector may be turned OFF.

CAUTION

Equipment damage may result if the mode selector switch is not left in the STBY position until all indicator lights are out before selecting OFF.

B Configuration

1. Turn hatch heater switch ON at take-off.
2. Turn master switch ON. This is usually done soon after takeoff to obtain a full record with the tracker camera.
3. Turn the jettison covers switch ON after reaching cruise altitude.
4. Turn the hatch heaters switch OFF before operating cameras.
5. Turn mode selector switch to STBY for at least sixty seconds before selecting an operating mode.
6. Set mode selector switch to desired mode before reaching target area.
7. Upon completion of mission, turn mode selector switch to STBY until all indicator lights are out. Then selector may be turned OFF.

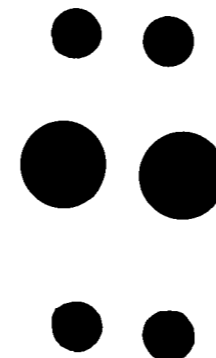
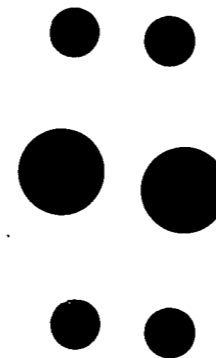
**CAUTION**

Equipment damage may result if the mode selector switch is not left in the STBY position until all indicator lights are out before selecting OFF.

NOTES

1. With any configuration, if the mode selector switch is turned to OFF, the automatic tracking function of the drift sight will not be operable.
2. Excessive corrections in aircraft heading and track should be avoided when close to a target due to the possibility of causing slight vibrations in the configuration equipment and consequent negative degradation.

ELECTRONIC INTELLIGENCE SYSTEMS

GENERAL

These systems are for the purpose of receiving and recording transmissions in various radar and communications bands. Figure 4-17 shows systems I, III, and IV.

SYSTEM I

This is a pickup and recording system for radar transmissions reaching the aircraft. The antennas and receivers are located in the fuselage nose just aft of the radio compass loop and are directed to both sides of the aircraft. The system will receive either X band or S band transmission, but only one band per flight since it must be pre-set. The tape recorder is located under the right aft console in the cockpit and has a capacity sufficient for ten hours.

This system requires no in-flight adjustment. It is turned on by the equipment master switch located on the driftsight control panel.

SECRET

This switch should be turned ON shortly after takeoff in order to obtain a complete mission record.

A majority of the airplanes have System I provisions.

SYSTEM III

This installation is for the purpose of receiving and recording VHF radio communications in the band of approximately 100 to 150 megacycles. The antenna is located on the lower fuselage just forward of the cockpit. The receiver and recorder are both located in the nose section.

No in-flight adjustment is required. The system is turned on by the equipment master switch located on the driftsight control panel. Provisions for this system are installed in the majority of the airplanes. Power supply is required from both the D-C and the A-C alternator systems.

NOTE

The A-C alternator must be ON for operation of this system.

SYSTEM IV

This is a pickup and recording system for radar transmissions reaching the aircraft. It is a wide band system and is mounted in the equipment bay. The antenna is located in a special lower hatch.

This system requires no in-flight adjustment and is turned on by the equipment master switch located on the driftsight control panel. Power is required from both the D-C and the A-C alternator systems.

NOTE

The A-C alternator must be ON for operation of this system.

F-2 FOIL SYSTEM

GENERAL

The F-2 Foil System hatch contains a particulate atmospheric sampler. This hatch is mounted to the lower opening of the equipment bay. When it is carried, most of the other major items which may normally be installed in the equipment bay cannot be used due to lack of space. The one exception is the P-2 Platform System which is compatible with the F-2 hatch.

NOTE

U-2 special equipment manuals, such as the F-2 Foil System manual, sometimes refer to a base altitude. This base refers to a pressure altitude of 40,000 feet.

The samples are collected on a series of six 16 inch diameter filter papers. These filter papers are rotated into and out of sampling position by an electric actuator. When a filter is in place, its exposure is controlled by a door in the air inlet duct. The door is opened by an electric actuator allowing outside air to be ducted in, passed through the filter and exhausted back outside.

RATE METER

A rate meter is provided in the cockpit to monitor the condition of the filter paper. The rate meter probe is mounted in the air duct and the indicator is on the rate meter control panel. A second rate meter is located on the automatic observer panel in the equipment bay. Both meters read in counts per minute (C. P. M.). A-C alternator power is required to operate this measurement system.

AUTOMATIC OBSERVER

The automatic observer is provided to record pertinent information regarding the sample and the environment conditions from

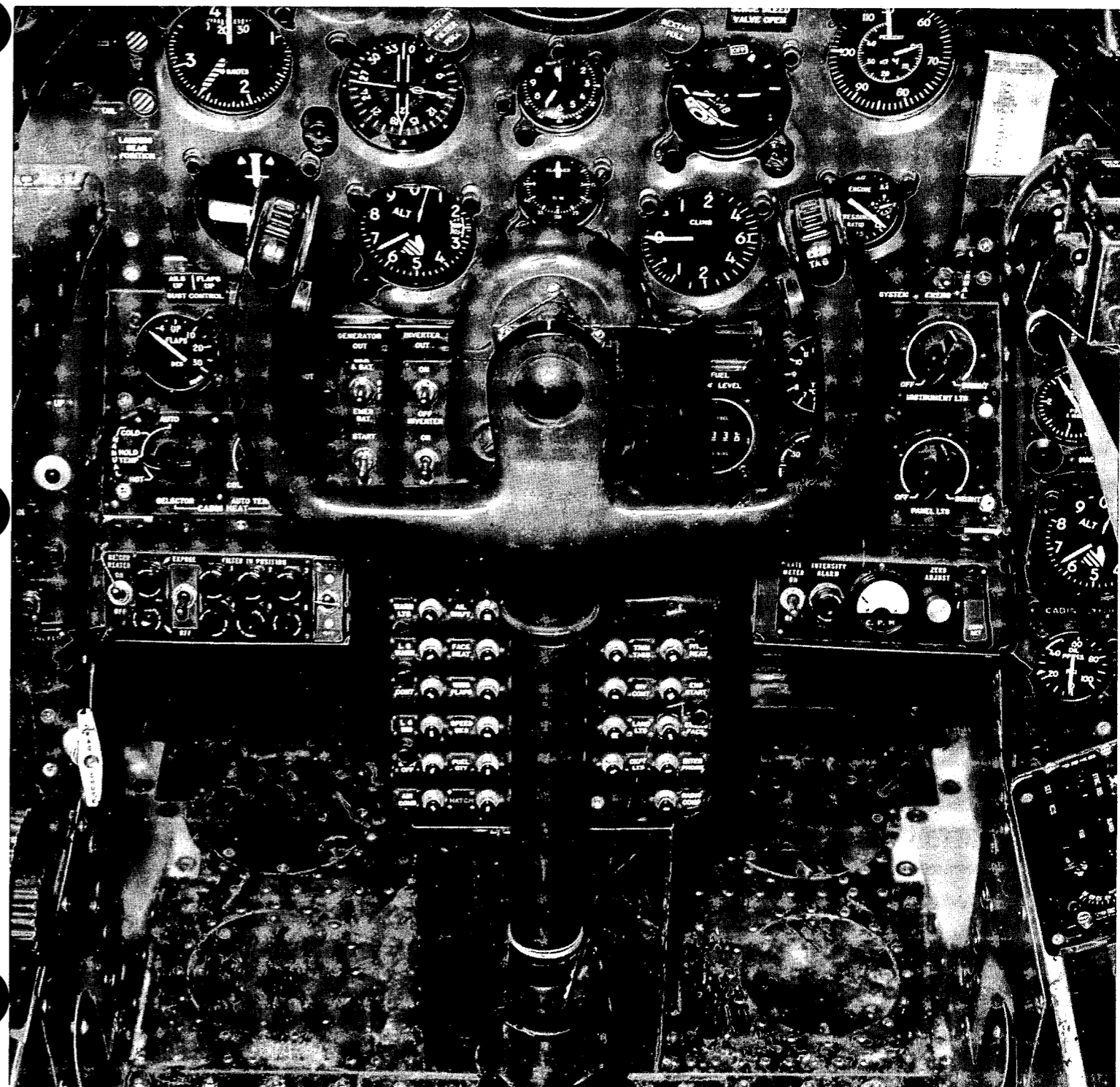

F-2 FOIL SYSTEM CONTROL PANEL SYSTEM

FIG. 4-18

~~SECRET~~

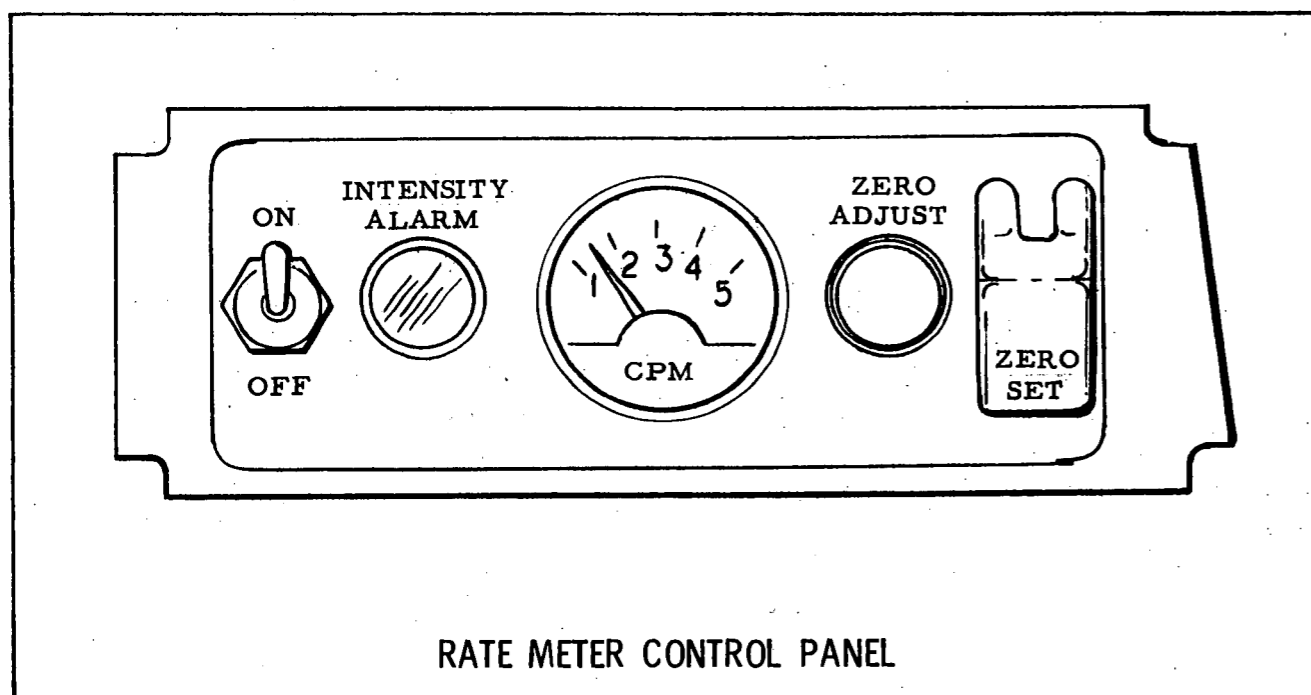
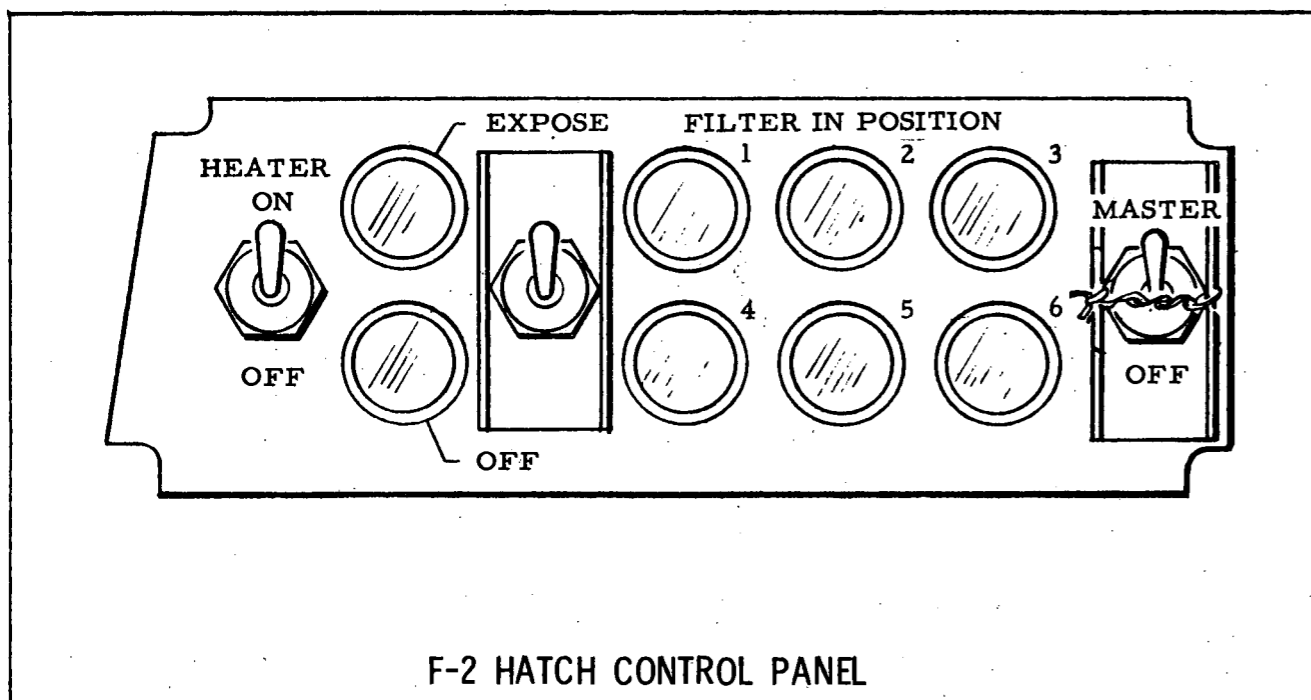

FIG. 4-19

SECRET

which it was collected. It is composed of a small instrument panel automatically photographed by a 16 mm camera. It is installed in the upper forward area of the equipment bay. The camera operates intermittently during the time that a filter is being exposed. The following items are provided on the automatic observer panel:

1. Rate Meter.
2. Altimeter.
3. Clock.
4. Free air temperature indicator.
5. Six filter-in-position lights for the F-2 hatch.
6. Four filter-in-position lights for the AFSWP nose.
7. Six indicator lights for use with Air Sampler System when installed.

CONTROLS**F-2 Hatch Control Panel**

This accessory panel is located below the left lower instrument panel as shown in Figure 4-18. The layout of switches and lights is as shown in Figure 4-19.

1. Master switch - This is safetied in the ON position and is not normally used.
2. Heater switch - This circuit furnishes heat to the duct closure door and to the filter pressure seals.
3. Expose-off switch - This switch opens the duct closure door when in the EXPOSE position. When moved to the OFF position, it closes the door and causes the next filter to be placed in position to be exposed. The automatic camera circuits are also energized in the EXPOSE position.
4. EXPOSE and OFF indicator lights - These amber lights show whether a

sample is being taken or not. These lights should correspond to the position of the switch.

5. Filter-in-position indicator lights - These green lights show which of the six filters is in position to be exposed.

Rate Meter Control Panel

This accessory panel is located below the right lower instrument panel as shown in Figure 4-18. The layout of switches and lights is as shown in Figure 4-19.

1. On-off switch - This provides power to the rate meter circuit.
2. Zero-set switch - This guarded switch provides proper circuit conditions for setting the meter zero.
3. Zero adjust knob - For setting the meter zero.
4. Rate meter - C. P. M. indicator.
5. Intensity alarm light - This light will glow at a preset value within the range of the CPM indicator. This value can be changed as desired by the ground crew.

OPERATION**Rate Meter Zeroing Procedure**

Before reaching the sample area, the rate meter should be zeroed in the following manner:

1. Turn A-C alternator switch to A-C ALT position.
2. Turn the rate meter power switch ON and allow approximately two minutes for warmup.
3. Open ZERO SET guard and turn zero-set switch ON (up).

4. Use the zero adjust knob to zero the rate meter.
5. Turn zero set switch OFF and close ZERO SET guard.

Filter System Procedure

The following procedure is used in the operation of the filter equipment:

1. Master switch - Safetied ON.
2. Heater switch - ON before takeoff and continuously during flight.
3. Rate meter - Operating and adjusted.

NOTE

The rate meter is not necessary for operation of filter equipment.

4. Expose-off switch - EXPOSE when a sample is desired. Length of time for a sample and time between samples as required.
5. Expose-off switch - OFF to terminate each sample. After the last filter is used, it will retract and the duct will be unobstructed.

Normal Operating Sequence

The normal sequence of events is as follows:

Before starting:

#1 filter-in-position light - ON.
Amber OFF light - ON.

To expose filter:

Expose-off switch - EXPOSE.
Amber OFF light - OFF.
15 seconds later, amber EXPOSE light - ON.
#1 filter-in-position light - Remains ON.

To terminate sample:

Expose-off switch - OFF.
Amber EXPOSE light - OFF.
15 seconds later, amber OFF light - ON.
#1 filter-in-position light - OFF.
15 seconds later, #2 filter-in-position light - ON.

This completes one cycle of operation. The #2 filter may now be exposed at any time.

CAUTION

Do not move expose-off switch to EXPOSE until the succeeding filter is in position and the filter-in-position light is ON.

Duct Flushing

When the sixth sample has been terminated, all of the filter-in-position lights will be out and the hatch duct will be unobstructed. At this time the duct may be flushed by moving the expose-off switch to EXPOSE for as long a period as desired.

AFSWP NOSE SYSTEM

GENERAL

The AFSWP nose contains a particulate atmospheric sampler. It performs the same functions as the F-2 Foil System hatch installation, but is a permanent installation in the fuselage nose of certain aircraft. The AFSWP nose is compatible with the F-2 hatch and all other equipment bay installations. However, Electronic Intelligence Systems I and III are not installed due to lack of space.

The samples are collected on a series of four 10 inch diameter filter papers. These filters are moved and exposed in a manner similar to the F-2 hatch except that they are all mounted in one disk and therefore the

duct is always blocked.

RATE METER

The same rate meter control panel is used for the AFSWP nose system as is used for the F-2 hatch system. On those aircraft which contain the AFSWP installation, a switch is provided on the AFSWP control panel for selecting whichever probe is desired to be connected to the rate meter.

AUTOMATIC OBSERVER

This installation is the same as for the F-2 hatch.

CONTROLS

The AFSWP nose control panel is located above the left console as shown in Figure 4-20. The controls and indicators are as follows:

1. Master switch - This 2 position on-off switch must be ON to operate the AFSWP nose panel.
2. Heater switch - This circuit furnishes heat to the duct closure door and to the filter pressure seals.
3. Expose-off switch - This 2 position switch actuates the duct closure door and the filter changer mechanism.
4. Expose-off lights - Two amber lights indicate when the door is open or closed.
5. Filter-in-position indicator lights - Four green lights indicate which filter is in position to be exposed.
6. CRM-TFR switch - This switch is used in conjunction with the rate meter to select the signal from the AFSWP nose sensing probe, or the F-2 hatch sensing probe when the F-2 hatch is installed. When the F-2 hatch is not installed, the nose probe is connected to the rate meter regardless of switch position.

OPERATION

In order to operate the filter sample system, the following procedure should be used:

Before Starting

1. Master Switch - ON.
2. Heater switch - ON before takeoff and continuously during flight.
3. Filter-in-position lights - Indicating #1 filter ready for exposure.
4. Rate meter - Operating and zeroed. Check zero periodically.

To Expose Filter

1. Expose-off switch - EXPOSE when a sample is desired. Length of time for a sample and time between samples varies with mission requirements.
2. Expose-off switch - OFF to terminate each sample.
3. Filter transfer - A new filter is placed into position automatically when the door is closed. It takes approximately 4 seconds for a new filter to be positioned in the duct.

NOTE

Approximate operating times are as follows:

1. Door opening - 15 seconds.
2. Door closing - 15 seconds.
3. Filter transfer - 4 seconds.

P-2 PLATFORM SYSTEM

GENERAL

This system is for the purpose of obtaining



AFSWP NOSE CONTROL PANEL

FIG. 4-20

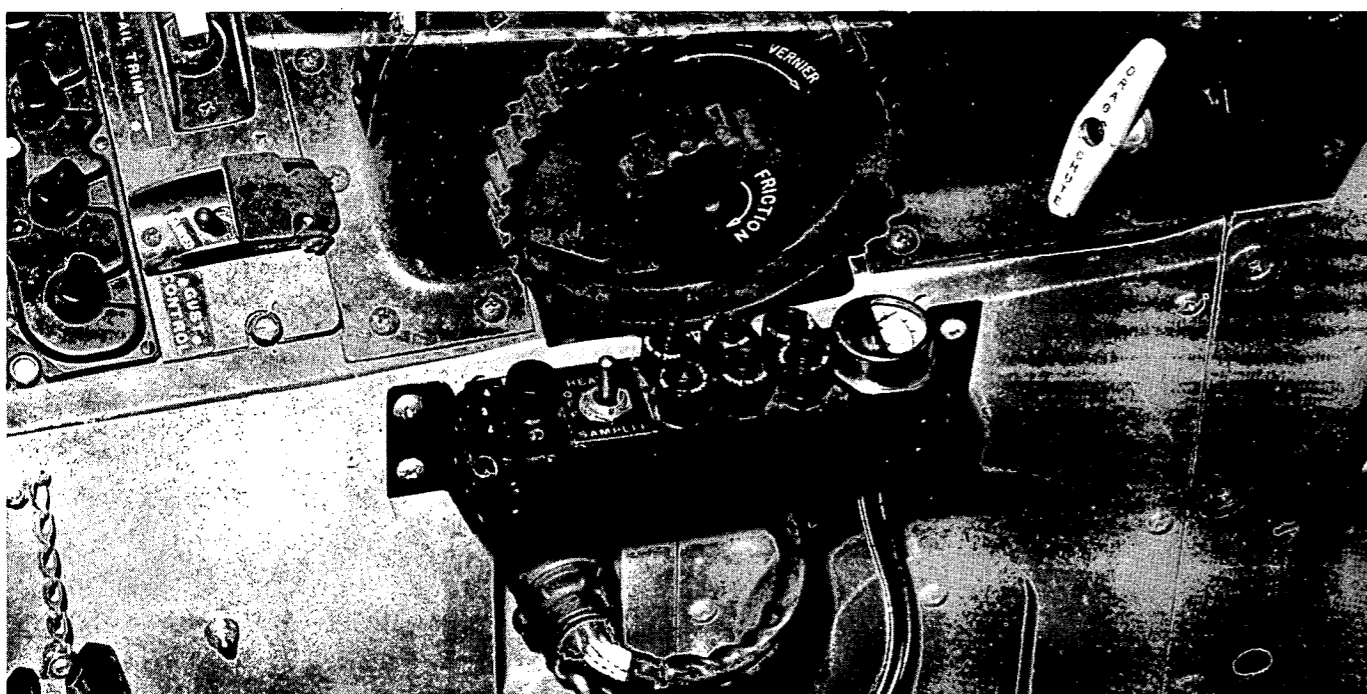

P-2 PLATFORM CONTROL PANEL

FIG. 4-21

and storing air samples. It may be installed in the equipment bay and is not compatible with any other major equipment bay installation except the F-2 Foil System hatch.

The air samples are compressed to 2300 psi and stored in six spherical shatterproof bottles. Each bottle is 13 inches in diameter and has a volume of 944 cubic inches. The air is compressed by a combination of three Rootes blowers and a 4 stage compressor.

The blowers are mounted in series and are driven by a single hydraulic motor. Hydraulic power is furnished by a pump driven by a 2 3/4 horsepower A-C motor. Electrical power is furnished by the ship's A-C alternator.

The compressor is driven by a 2 3/4 horsepower 28 volt D-C motor.

Operation of the system is automatic and no pilot attention is required to switch from a full bottle to an empty one. The same automatic observer installed for the F-2 Foil System hatch may be used.

CONTROLS

The control panel is located on the side of the left console below the throttle as shown in Figure 4-21. The following controls and indications are provided:

1. Heater-off-sampler switch - This switch turns on either the air inlet heater or the sampler.
2. Bottle-full indicator lights - Six green lights are provided to show when each successive bottle is filled.

NOTE

After a bottle has been filled and its bottle-full indicator light is ON, it is possible for a leak in that bottle to allow the pressure to decrease, causing the bottle-full indicator light to go OUT again. It is not possible to go back and refill this bottle.

3. Pressure gage - Indicates the pressure in the bottle being filled.
4. Six position selector switch - This selector is provided to give manual change over or selection of bottle to be filled if it is required to override the automatic system. It is possible to select successive bottles with this selector switch, but it is not possible to return to a bottle already passed over.

NOTE

When entering cockpit on a mission using this equipment, the selector switch should be in the #1 position. If the switch is in any other position, check with the ground crew for equipment status.

OPERATION

Normal operation is as follows:

1. A-C alternator - ON.
2. Heater-off-sampler switch - HEATER for takeoff.
3. Heater-off-sampler switch - SAMPLER when a sample is desired.
4. Heater-off-sampler switch - OFF when bottles are full or when it is desired to save remaining empty bottles for later use.

NOTE

It takes approximately 1 1/4 hours to fill a bottle to 2300 psi.

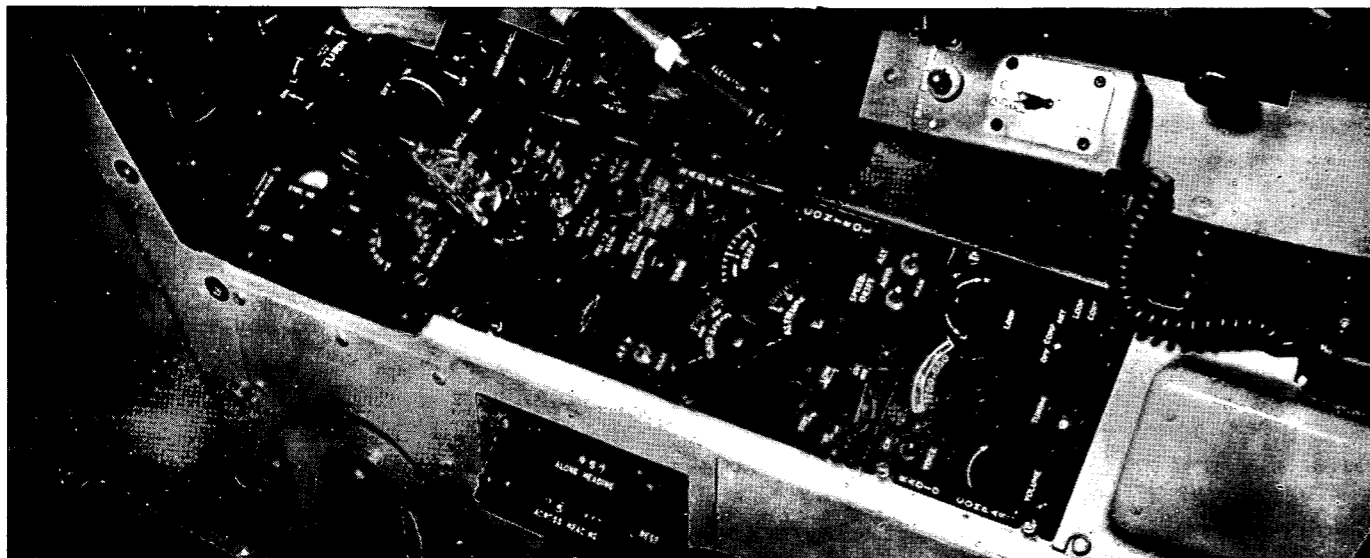

FIG. 4-22 APQ-56 CONTROL PANEL

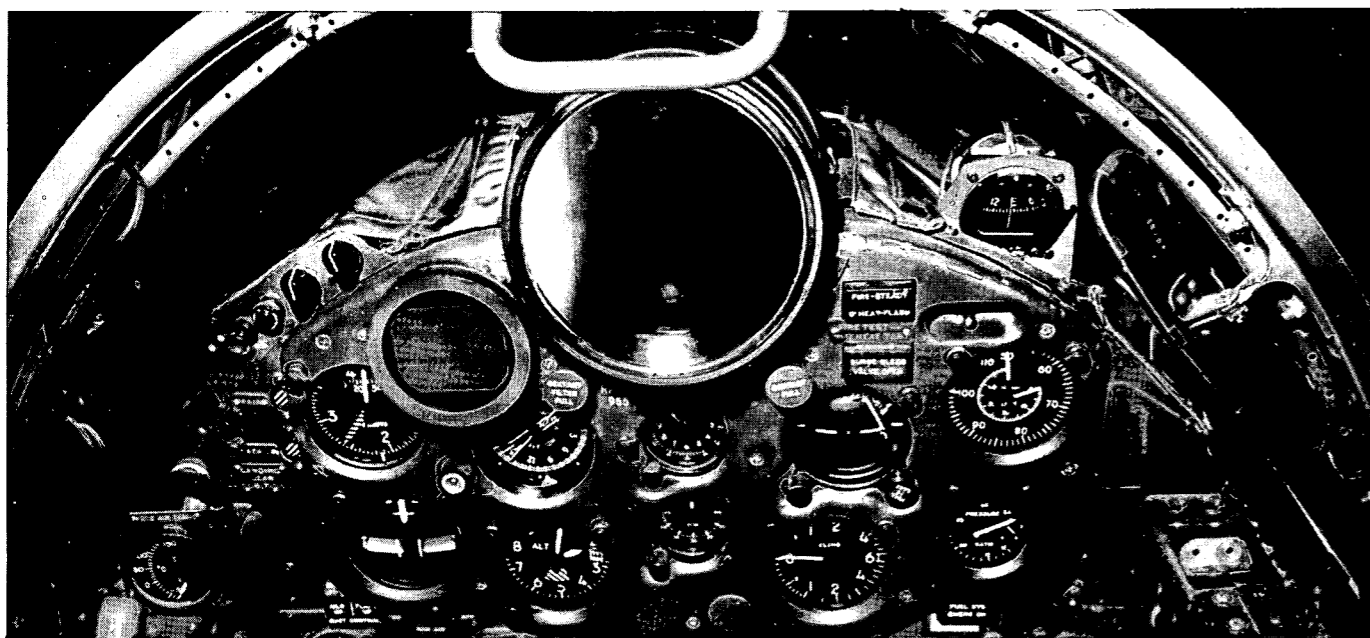

FIG. 4-23 APQ-56 MONITOR SCOPE

APQ-56 RADAR MAPPING EQUIPMENT

GENERAL

Certain aircraft are provided with an APQ-56 radar. This radar mapping set is a single band side-looking system which, through use of a double antenna and a time-sharing system, provides ground surveillance on both sides of the aircraft. Adjustment of the radar in flight is accomplished by circuits in the cockpit control panel located on the right console as shown in Figure 4-22.

The dual antenna is rigidly attached to the bottom of the fuselage and its beams are set at right angles to the longitudinal axis of the aircraft. Antenna scanning is provided only by the forward motion of the aircraft. During operation of this equipment the radar returns are recorded by a 70 mm camera on a continuously moving strip of film resulting in a ground-map presentation. The system is capable of mapping a strip of terrain beginning directly under the aircraft and extending to a range of 15 nautical miles on each side of the aircraft.

NOTE

Because of antenna arrangement, there is a loss of coverage 1/4 mile wide directly below the aircraft. Best mapping is obtained by flying approximately seven miles to the right or left of the target.

Photographs of the radar returns on each side of the aircraft are made alternately on their corresponding half of the strip film, and are so placed that the break between the right and left presentation is almost imperceptible. A lens and shutter arrangement in the camera records approximately 15 scans on each side of the aircraft in succession. Time and reading are recorded on the edge of the film strip every fifteen miles. At the same time, precision slant range marks are presented with every fifth mile mark brightened. Three factors, altitude, drift, and ground speed, must be taken into account for proper mapping. Drift and ground speed may be set into

the radar system either manually or automatically. Altitude may only be set manually. The manual setting of altitude, drift, and ground speed is accomplished by adjusting potentiometers on the APQ-56 control panel. This system will operate at altitudes from ground level to over 70,000 feet and at ground speeds between 200 and 1,000 knots.

NOTE

Above 70,000 feet, an "altitude hole" will exist, resulting in loss of target areas under and close into the aircraft. Full 15 mile coverage will not be obtained above 70,000 feet.

A scope is provided for the pilot to monitor the radar returns so that he can make the necessary adjustments to the APQ-56. The controls for the monitor scope do not affect the operation of the radar mapping equipment.

The APQ-56 radar mapping equipment requires both D-C and A-C alternator power.

RADAR MAPPING CONTROLS

The radar mapping control panel is located on the right console directly aft of the MARK III driftsight in conjunction with which it is used. This installation is shown in Figure 4-22. The following controls are on the APQ-56 control panel:

Test Meter

A test meter is located at the left forward corner of the control panel. This meter is used to monitor the current flow for various major components of the system.

Meter Selector

A six position meter selector switch is used in conjunction with the test meter to monitor various components of the radar system. The six positions are REC #1 XTAL, REC #2 XTAL,

AFC #1 XTAL, AFC #2 XTAL, MAG, and CRT INT. The functions of these positions will be discussed later.

Klystron Tune Knob

The Klystron tune knob is used to tune in the targets which appear on the monitor scope. At the same time there will be an indication on the test meter when the meter selector switch is in the AFC #1 or AFC #2 position.

Gain Knob

A gain knob is provided to adjust the target strength on monitor traces. The target strength varies with the type of terrain over which the system is operating.

AFC-MAN Switch

This switch is provided for automatic frequency control when tuning the receiver circuits. In the AFC position the circuits are tuned to exactly a 45 mc pulsed signal which eliminates much retuning of the set during continuous operation. The MAN position is provided for initial tuning of the system and emergency operation of the system if a failure is encountered in the AFC circuit.

Ground Speed Knob

A ground speed knob is provided to manually set in the airplane's ground speed. The ground speed setting is indicated by the dial adjacent to the knob.

Drift Knob

The drift knob is provided to manually set in the airplane's drift angle. The drift angle setting is indicated by the dial adjacent to the knob. This is actual drift of the aircraft and not drift correction.

Altitude Knob

An altitude knob is provided to manually set in true altitude above the ground. This is seldom the same as the pressure altitude as read from the altimeter. The altitude setting is indicated by the dial adjacent to the knob.

NOTE

When applying drift compensation, set in the actual airplane drift and not the drift correction required to hold course. For example; if there is a wind from the left with left yaw required to hold course, then the effective drift is right and the setting should indicate right drift.

Off-Stby-LowPwr-High Pwr Switch

This switch turns the set off and on. The standby position is provided for warmup and to allow time for the system to pressurize. For operation of the equipment the high power position is always selected, but there is no functional difference between the low power and the high power setting.

Speed-Drift

This switch has AUTO and MAN positions. For manual setting of speed and drift, place in the MAN position. In the AUTO position, speed and drift will be supplied by the PC-210A Radan equipment.

Altitude Switch

This switch has AUTO and MAN positions. However, there is no automatic altitude input at any time and the switch should always be in the MAN position.

MONITOR SCOPE CONTROLS

There are two locations for the monitor scope and its controls which are presently in use. In the earlier configuration, the

scope is located on the right side of the cockpit aft of the ARN-6 radio compass control panel. The screen faces forward and is viewed by the pilot by looking into a mirror. The scope controls are directly below the screen.

In the later configuration, the monitor scope is to the left of the driftsight viewing screen. The scope controls are on the left top edge of the main instrument panel. This installation is shown in Figure 4-23.

The scope controls consist of the following:

Focus Knob

A focus knob is provided to adjust the focus of the monitor traces.

Intensity (INT) Knob

An intensity knob is provided to adjust the intensity of the monitor traces.

Low Pressure Light

An amber low pressure light indicates loss of pressurization in the radar equipment. It is necessary to have pressurization for the equipment to operate.

Film Advance Counter

This counter advances one count for each 15 ground miles or 1 7/8 inches of film; therefore, the interval between counts will vary with ground speed. If the counter stops advancing, this may indicate a film drive malfunction.

NOTE

This counter is found only on the earlier configuration control panel mounted below the scope on the right side of the cockpit.

Radar Run Light

A green radar run light comes on approximately five minutes after the off-stby-low pwr-high pwr switch is set to LOW PWR or HIGH PWR. This indicates the set is functioning.

NORMAL OPERATION

1. Preliminary settings for APQ-56 operation:

A-C alternator ON.

Meter selector knob to MAG.

Gain knob to mid-position.

Ground speed dial to ZERO.

Altitude switch to MAN.

Speed-drift switch to MAN.

Altitude dial set to read 10,000 feet lower than the mission altitude.

Klystron knob left untouched.

AFC-MAN switch to MAN.

Drift dial to ZERO.

Off-stby-low pwr-high pwr switch OFF.

2. After takeoff, turn off-stby-low pwr-high pwr switch to HIGH PWR. Allow fifteen minutes for the equipment to warm up. When the system is first turned to HIGH PWR, the yellow radar run light on the monitor scope control panel will come on momentarily until the system has pressurized. Approximately one minute after going to HIGH PWR, dual vertical traces will appear on the monitor scope. Four and a half minutes after going to HIGH PWR, the green radar run light will come on.

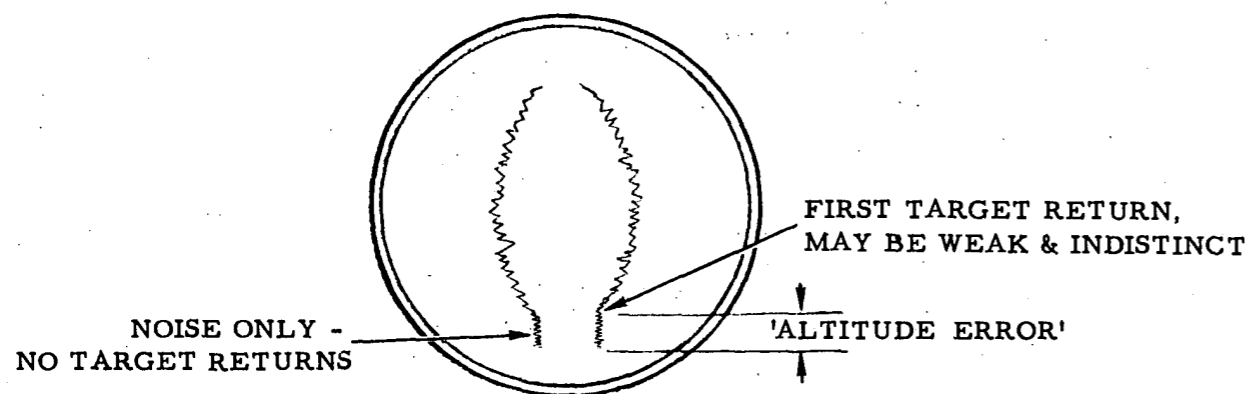

FIG. 4-24 APQ-56 MONITOR SCOPE TRACES -
ALTITUDE SET LOW - AIRCRAFT WINGS LEVEL

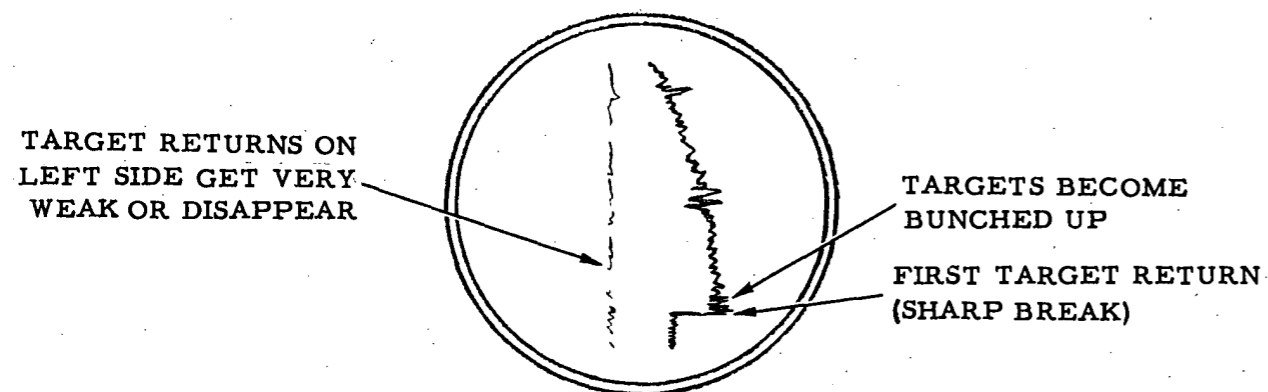

FIG. 4-25 APQ-56 MONITOR SCOPE TRACES -
ALTITUDE SET LOW - AIRCRAFT IN RIGHT BANK



FIG. 4-26 APQ-56 MONITOR SCOPE TRACES -
ALTITUDE SETTING CORRECTED -
AIRCRAFT IN RIGHT BANK

3. Check that the meter on the control panel reads .7 to .9 in the MAG position.
4. Turn the meter selector knob to AFC #1 XTAL for the remainder of the flight except when checking other readings. Always return to AFC #1 XTAL position. In this position the meter should read .15 to .5.
5. Adjust the Klystron tune knob for maximum meter reading and maximum target strength on the monitor scope. Target strength is indicated by the amplitude of the horizontal spikes on the dual vertical traces. Adjust the focus and intensity knobs on the monitor scope control panel for a sharp and clean presentation. Adjust the gain knob as necessary, depending on target strength on the scope and knowledge of the area being covered. Heavily built up areas or rough terrain will give strong target returns. The meter reading should remain steady.

NOTE

Maximum meter reading may be obtained at two different positions of the knob. However, target lock-on can be obtained at only one position. Select the position where the meter reading is maximum and the targets lock-on. Lock-on is indicated by steady targets which do not disappear and reappear.

6. Turn the meter selector knob to the remaining positions and check for these readings:

AFC #2 XTAL15 to .5
MAG7 to .9
CRT INT4 to .6
REC #1 XTAL15 to .4
REC #2 XTAL15 to .4

Any large discrepancies should be recorded.

7. Flip AFC-MAN switch to AFC. The meter reading for AFC #1 XTAL position may or may not remain steady. The targets on the scope will follow the behavior of the meter reading. If the meter remains steady, the targets will be steady. If the meter reading fluctuates from maximum to zero and back again to maximum, the targets will follow by disappearing at zero and popping back in again at maximum. For the condition where the meter and targets remain steady, it is only necessary to slightly adjust the Klystron tune knob to peak the meter and sharpen the targets. For the condition where the meter and targets become erratic, it is necessary to adjust the Klystron tune knob until the meter is again peaked to maximum and the targets are also maximum on the monitor scope. It is important that the meter remain steady at all times. All of above tuning is done with AFC-MAN switch in AFC position. Leave switch in this position.

8. If automatic inputs of speed and drift are desired from the PC 210A radan, merely flip the speed drift switch to the AUTO position. In this position, both ground speed-drift dials are inoperative. For manual inputs, flip speed-drift switch to MAN position and set in the data on the dials from the best source of information available.

9. Just prior to beginning a target run, it is necessary to accurately set in the altitude. This is done with the aid of the monitor scope presentation. Before making this adjustment, the scope presentation will look like Figure 4-24. Since the altitude dial was set 10,000 feet lower than the mission altitude, an altitude error will show near the beginning of the trace. Leaving the altitude switch in the MAN position, bank the aircraft about 10° toward a primary target area. Assuming the bank is to the right, the scope presentation will

assume an appearance similar to Figure 4-25. With the right wing low, the targets on the right trace will bunch up and become more distinct. Targets on the left monitor trace will appear greatly weakened or even disappear. While maintaining the aircraft in the bank, adjust the altitude knob toward a higher reading. The targets on the right trace will slowly start to slide toward the lower end of the trace. There is a slight delay between the movement of the altitude knob and the movement of the targets along the trace. Therefore, adjust the knob in small increments. Wait until the targets stop moving and adjust the knob again. Continue adjusting until the first target return "sits" on the start of the trace. Disregard the left trace while making this adjustment. The monitor scope should now look like Figure 4-26. The altitude is now correctly set into the system. Return to level flight. The system is now ready for the target run.

10. On early configurations the film advance counter will advance one count periodically. The period depends upon the setting on the ground speed dial (in MAN position), or the value set in by the PC 210A radan (in AUTO position).
11. If the system is not needed for a long period, switch to STBY. When needed, turn to HIGH PWR and the system will come on after a two second delay.
12. The A-C alternator which supplies APQ-56 power, cuts out when engine RPM falls below 86%. Keep engine RPM above 86% for APQ-56 operation.

EMERGENCY OPERATION

If targets and/or meter reading deteriorate or become erratic, it may be possible to regain performance by moving AFC-MAN switch to MAN. Retune the set and try AFC again. If there is still evidence of erratic operation, continue operation in the MAN position. It will be necessary to readjust the Klystron tune knob occasionally for maximum targets

and meter reading.

If the green radar run light goes off and targets disappear, check the yellow low pressure light. If the low pressure light is off, turn the system to STBY for a minute and then back to HIGH PWR. Turn meter selector switch to MAG and check meter reading. If this fails to return the system to operation, turn system off. If the low pressure light is on, turn system to STBY. Descend to a lower altitude and wait for the light to go out. If it does go out, resume normal operation at this altitude if operational conditions permit. The probable cause of trouble is a leak in the equipment pressurization system, whereby the pressurization pump cannot maintain proper pressure at the higher altitude.

Loss of one trace on the monitor scope should be ignored and the flight continued by monitoring the remaining trace. If both traces are lost, check MAG and CRT readings on the meter. If meter readings are proper, system operation may be continued, but altitude will have to be estimated.

NOTE

In any instance of system malfunction, all meter readings should be recorded.

WEATHER SURVEY EQUIPMENT

GENERAL

The weather equipment is a package unit which is installed in the equipment bay for special flights. The unit contains instrumentation to measure and record airspeed, altitude, free air temperature, humidity, acceleration, time and aircraft heading. The heading information is obtained from the airplane gyrosyn compass system.

Three of the packages, known as FOG weather packages, have a coder panel mounted on the left console near the map case. This coder is used by the pilot to record his visual observations of meteorological phenomena.

A special hatch is required when the weather equipment is flown. External test probes essential to the measurements are installed in the hatch. A standard tracker camera is also installed to observe terrain features and cloud formations for coordination with the recorded data.

No special switches (other than the coder mentioned above) are provided in the cockpit for control of the equipment. A three position on-off-test switch is installed in the external power receptacle. This switch is used by the ground crew to turn the equipment on before takeoff. The TEST position is provided for ground checkouts. Equipment power is supplied by the D-C generator.

NOTE

On FOG weather packages, the external power receptacle switch is not used, but a similar switch is provided on the weather rack.

OPERATION

After takeoff, the master switch on the drift-sight control panel should be turned ON to operate the tracker camera. No other action is required from the pilot. No lights are provided to indicate equipment operation. In case of an engine flameout, the equipment will operate until the windmilling RPM becomes low enough for the D-C generator to drop out as indicated by the GENERATOR OUT light. The equipment will then stop operating and will not drain the battery during a power-off descent. When the engine is restarted, and the D-C generator is up to speed, the weather equipment will again start operating.

NOTE

If an electrical fire in the weather equipment is suspected, the equipment can be turned off by selecting BAT only on the battery-generator switch. If desired, the equipment can be turned back on by switching to GEN & BAT position.

DESTRUCTOR

GENERAL

An explosive device is provided for emergency destruction of the airplane. A control box is installed on the right cockpit sill just forward of the canopy. The control has a guarded arm switch, a guarded destroy switch, and a DESTRUCTOR TIME DELAY ON blue warning light. The control box is equipped with an extra length of electrical cable so that it can be relocated to some other place in the cockpit if desired.

The destructor is located in the equipment bay and contains approximately 2.5 pounds of a high explosive. A manual safety device, located on the destructor, must be preset prior to flight for the destructor to be operable electrically.

This unit is used in another application and has undergone exhaustive tests to prove its reliability. It has a number of safety features, including the before mentioned manual safety pin which must be set before flight, a rotor which blocks the passage ways from the primer to the main charge, a shorting fuse and switches which electrically isolate the primers. It is considered the safest and most reliable unit available.

TIME DELAY

A special relay timer in the electrical circuit allows a delay between release of the destroy switch and detonation. This timer is nominally set for ten seconds, but is ground adjustable for periods from zero to approximately 45 seconds. A checkout box is provided for checking and adjusting the timer as necessary.

POWER SUPPLY

The electrical power supply to the destructor circuits is disconnected when the generator is turned on and operating properly. Therefore, the GENERATOR OUT light must be glowing or the BAT only position must be selected in order to fire the destructor.

CONTROLS

The guarded arm switch has only the function of energizing the electrical circuits. It does not initiate any other action.

The guarded destroy switch is a momentary switch which initiates the firing cycle. The timer runs its preset time delay period from the time the destroy switch is released. An additional full period can be obtained any time the switch is re-energized.

NOTE

The detonator may be stopped at any time after arming or during the firing cycle by pushing the cover down on the arm switch.

The blue warning light indicates that the timer is running. The light will remain on until the arm switch is turned off. If the arm switch is turned off and back on before the delay period has expired from the time the destroy switch was first actuated, the light will come back on. This does not mean the timer is going to fire the detonator. It is always necessary to energize the destroy switch after the arm switch in order to start the firing cycle.

OPERATION

The firing cycle should be initiated only after the pilot is completely ready to leave the airplane. This includes canopy, oxygen quick disconnect, etc.

For Bailout:

1. Make all the usual preparation.
2. Move generator-battery switch to BAT position.
3. Lift arm switch guard and select ON.
4. Lift destroy switch guard and select momentary ON, then release.

NOTE

Release of switch initiates the pre-set time delay. The warning light is ON during the time delay cycle and the destructor is fired at the end of this period.

5. Bail out.

For Use After Landing:

Same as for bailout, except disconnect the seat pack and throw it out if desired. Don't try to run with it on. Get as far from the airplane as possible after releasing the destroy switch.

RADAR DOPPLER AUTOMATIC NAVIGATION SYSTEM (RADAN)

GENERAL

A few aircraft are equipped with this navigation system which uses Doppler radar techniques to measure ground speed and drift angle directly, continuously, and accurately. It operates equally well at all points of the globe, except over smooth surfaces such as still water, ice or snow. It is unaffected by weather conditions and is completely independent of ground-based aids. Ground speed data is accurate to one percent or five knots, whichever is greater, and drift angle to 0.5 degrees within altitude limits of 200 to 70,000 feet and ground speed limits of 70 to 1000 knots.

NOTE

Satisfactory operation has been attained at altitudes above 70,000 feet.

Two models of this system are used in this aircraft. These systems both require only 28 volt D-C power from the aircraft system.

PC-210A RADAN

The PC-210A is the model used in conjunction with the APQ-56. The ground speed and drift information supplied by the PC-210A Radan is fed automatically into the APQ-56 Radar Mapping System. This alleviates the necessity of feeding this information manually and reduces the probability of erroneous pre-flight wind information.

Display Indicator

The display indicator, shown in Figure 4-27, is located on the left console. It presents the pilot with a visual indication of drift angle and ground speed. The drift is indicated by a needle-dial arrangement which gives left or right drift in degrees. On the upper left of the dial is an OFF flag which disappears when drift equipment is operating properly and reappears when drift equipment is erroneous, when track is momentarily lost (such as over smooth water), or when the equipment is turned off. The ground speed is indicated on a counter type dial and reads directly in knots. This dial also has an OFF flag whose operation parallels that of the drift indicator flag.

Control Panel

The Radan control panel shown in Figure 4-28 is also located on the left console. It contains the three switches necessary to operate the equipment.

On-Off Switch - This is a two position switch for turning the PC-210A on and off. It is labeled ON and OFF.

Speed Switch - This is a three position switch spring loaded to the middle position used in "slewing" or adjusting the approximate ground speed on the display indicator. This is a necessary operation because of harmonic frequency phenomena. The switch is labeled INCR, which runs the ground speed control to a higher figure, and DECR, which decreases the ground speed figure.

Drift Switch - This is a three position switch, spring loaded to the middle position used in "slewing" or adjusting the approximate drift on the display indicator. The switch is labeled L, which moves the needle to the left, and R, which moves the needle to the right.

Lock-on Lights - Located on the top of the forward side panel are two green lock-on lights labeled RADAN LOCKED. The left light is further labeled DRIFT ANGLE, and the right GROUND SPEED.

System Operation

The first step in operating this system is to turn the off-on switch to ON and allow a few minutes for warmup of the system. Then, when in straight and level flight, set into the display indicator the approximate ground speed as computed in preflight information by use of the speed switch. If the ground speed on the dial is low and the computed ground speed is shown to be 215 knots, hold the speed switch on INCR until the dial reaches approximately 215 knots. As the reading approaches the true ground speed, the OFF flag will disappear and the speed switch can be released. The Radan equipment will take over, make final adjustments, and display on the indicator the true ground speed. If the ground speed on the dial is high when this operation is started, the speed switch should be moved to the DECR position and a similar operation may be performed. Next, it is necessary to slew in the drift angle. Set in the approximate drift as precomputed by using the drift switch. If the drift angle is reading to the right and the computed drift is shown to be 0°, hold the drift switch on L until the dial reaches approximately 0°. As the reading approaches the actual drift, the OFF flag will disappear and the drift switch can be released. The Radan equipment will take over, make final adjustments, and display on the indicator the actual drift angle. If drift angle is initially to the left, the drift switch must be held on R to move the needle to the right.

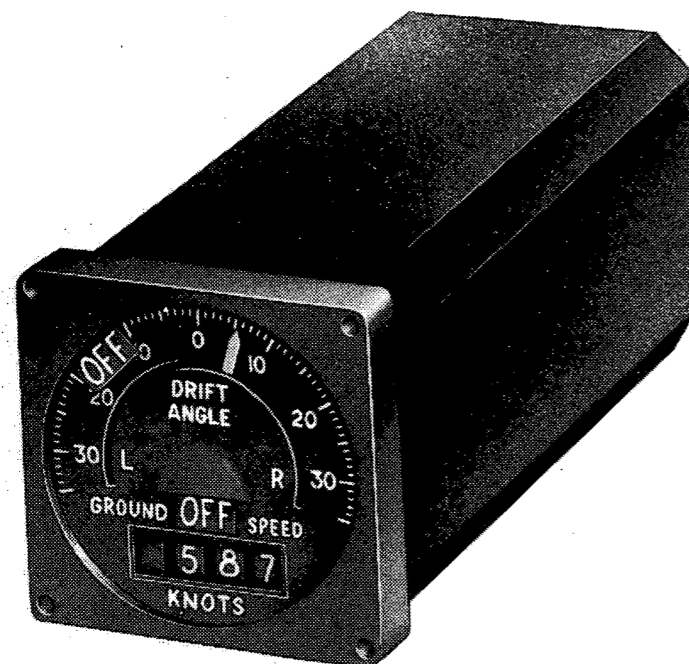

RADAN DISPLAY INDICATOR
FIG. 4-27

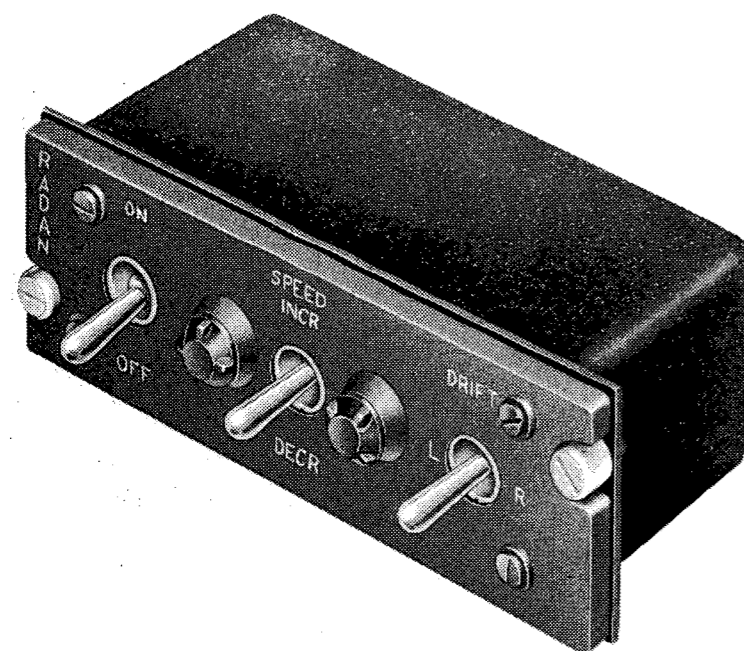

RADAN CONTROL PANEL
FIG. 4-28

NOTE

This equipment is limited to flight attitudes of $\pm 5^\circ$ bank and $\pm 10^\circ$ pitch. When banking the aircraft more than 5° , the drift angle OFF flag may appear. The system at this time is not giving a true drift angle and after rolling out of the bank, it may be necessary to re-adjust the system as outlined above.

When both OFF flags disappear, the two green lock-on indicator lights should come on. This indicates that the drift angle and ground speed information is available to the APQ-56 and the automatic function of the APQ-56 may be used.

PC-204A RADAN

The PC-204A is the Radan model which is used in conjunction with the ASN-6. This is essentially the same system as the previously discussed PC-210A except for the location of the controls. The PC-204A feeds drift angle and ground speed into the ASN-6 where it is used in computing actual position over the ground.

Display Indicator

This is the same indicator as is used with the PC-204A, except that it is located on the right console, with the ASN-6 controls.

Control Panel

This control panel is the same as the PC-210A panel, except that it is located on the right console just aft of the ASN-6 controls.

System Operation

To operate the PC-204A system, it is necessary to turn the ASN-6 inverter switch, located on the ASN-6 control panel, ON. The subsequent operating procedures are identical with those for operating the PC-210A

system.

NOTE

With the PC-204A system, there are no green lock-on lights.

AN/ASN-6 LATITUDE AND LONGITUDE COMPUTER

GENERAL

Certain aircraft are provided with an AN/ASN-6 Latitude and Longitude Computer. This electronic system is used for determining the geographical position of the aircraft in flight. It continuously computes and displays the aircraft's latitude and longitude in the form of a digital readout from 70° north to 70° south. It is capable of operating at ground speeds of 70 to 800 knots.

A PC-204A Radan system is used in conjunction with the ASN-6 installation in order to provide the necessary drift angle and ground speed information to the ASN-6 computer.

CONTROLS AND INDICATORS

A panel is provided on the right console which includes the following controls and indicators, as shown in Figure 4-29:

- Inverter On-Off Switch - This switch turns on the ASN-6 inverter, thereby providing 115 volt, 400 cps power to the ASN-6 and the PC-204A Radan power relays.
- ASN-6 Power Switch - This switch operates the ASN-6 power relay, thereby providing both A-C and D-C power to the ASN-6 equipment.
- Magnetic Variation Switch - This switch, labeled VARIATION, is used to select either manual or automatic input of mean magnetic variation. In the AUTO position, the CP-290

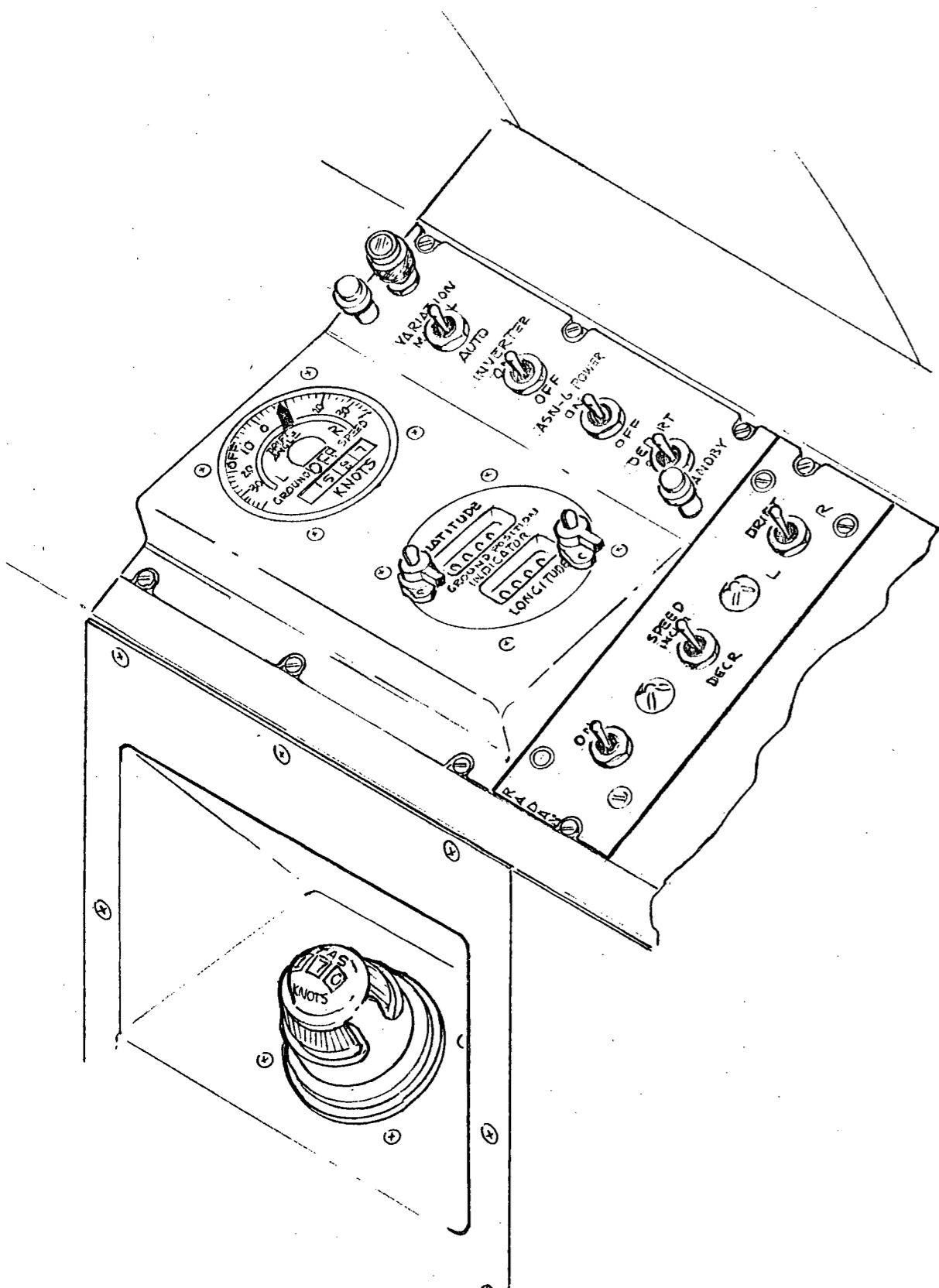

AN/ASN-6 RIGHT CONSOLE CONTROL PANELS
FIG. 4-29



C-1316/ASN-6 RIGHT CONSOLE CONTROL PANEL

FIG. 4-30

Magnetic Variation Computer automatically feeds the proper variation information into the ASN-6 system. The pilot must provide this information during MANUAL variation operation.

position indicator. One is next to the latitude readout and the other is next to the longitude readout. They are used to slew (drive) the respective readouts to the latitude and the longitude of the selected departure point.

- d. ASN-6 Manual Light - This press-to-test light is ON when the Radan equipment is off, in which case manual wind and airspeed information is required.
- e. Depart Switch - This switch starts the computing system when it is turned ON and stops the computing system when turned to STANDBY.
- f. Radan Indicator - This indicator is part of the PC-204A Radan system and provides a visual display of ground speed and drift angle.
- g. ASN-6 Ground Position Indicator - This indicator consists of two digital readouts which are calibrated to read latitude and longitude in one half minute increments.
- h. Slew Switches - These two switches are mounted on the face of the ground

Directly aft of the ASN-6 control panel on the right console is a PC-204A Radan control panel.

A true speed control is mounted in a setback in the side of the right console below the ASN-6 control panel as shown in Figure 4-29. This control is used to set true airspeed manually into the ASN-6 computer when the Radan is not in use.

A C-1316/ASN-6 G. P. I. Control Panel, as shown in Figure 4-30, is mounted in the left console. It contains the following controls:

- a. Wind Direction - This control, labeled WD, is used to set in "navigator's wind" manually when the Radan is not in use.
- b. Wind Force - This control, labeled WF, is used to set in the wind velocity in knots manually when the Radan is not in use.

c. Variation - This control, labeled VAR, is used to set in the mean magnetic variation of each leg of the flight when the variation switch on the right console panel is in the MANUAL position.

7. Wind Force - Set in wind velocity in knots.
8. Variation - Set in mean magnetic variation of the first leg of the flight.
9. Depart Switch - ON, when over the departure point.

OPERATION

The ASN-6 may be operated in either of two modes. It may be operated automatically, using the PC-204A Radan for wind velocity and direction information, or it may be operated by manually setting in the wind information. If for any reason the Radan goes off, the system will automatically switch to manual operation. For this reason, the precomputed wind and airspeed information should always be preset on the manual dials.

NOTE

The automatic magnetic variation computer functions independent of Radan operation.

To operate equipment:

1. Inverter - ON (allow for warmup).
2. ASN-6 Switch - ON.

CAUTION

Turn the inverter switch ON before turning the ASN-6 switch ON.

3. Slew the ground position readouts to the latitude and longitude of the departure point.
4. Magnetic Variation Switch - AUTO.
5. True Air Speed Vernier Dial - Set in precomputed airspeed.
6. Wind Direction - Set in "navigator's wind".

To turn off equipment:

1. ASN-6 Switch - OFF.
2. Inverter Switch - OFF.

MA-1 COMPASS SYSTEM

GENERAL

The MA-1 Compass System is a remote indicating gyro-stabilized compass system designed for use in all latitudes. It consists of a magnetic flux valve located in the left wing tip of the airplane; an MA-1 gyro and amplifier located in the right side of the fuselage just forward of the wing leading edge; a pilot's directional indicator; and a compass controller, shown in Figure 4-31, which is located on the right forward console. The system may be operated either as a magnetically slaved compass, or as a free directional gyro with correction for the effect of the earth's rotation. The system provides reference signals for directional control of the autopilot and heading information for the pilot's directional indicator.

The compass system requires both D-C and inverter power.

MAGNETICALLY SLAVED SYSTEM

Operation as a magnetically slaved compass may be used in any locality except near the magnetic poles or in areas where severe magnetic distortion occurs. When operated in this mode, the flux valve defines the direction of magnetic north. The electrical signals from the flux valve are supplied to the MA-1 gyro and amplifier. These components in turn furnish the heading information

to the autopilot and directional indicator in the cockpit.

FREE DIRECTIONAL GYRO

Operation as a free directional gyro may be used in any latitude but is especially useful where the magnetic field is weak or distorted. Distortion occurs at any latitude when in close proximity to large masses of iron or steel. Above approximately 60° latitude, the declination of the earth's magnetic lines of force creates errors in a magnetically slaved system, and the free mode should be used. In this mode the heading information is provided by the orientation of the MA-1 gyro and is in turn transmitted to the autopilot and directional indicator.

MANUAL FAST SLAVING

Before Takeoff

The normal slaving rate of the system is about 2 degrees per minute. When the compass system is energized before takeoff, the gyro may be as much as 180 degrees from the proper heading. At normal slaving rates

about 1 1/2 hours would be required to slave to the correct heading. Therefore, manual fast slaving is provided. By using the set-heading switch, the heading can be changed at the rate of 720 degrees per minute. Thus, it takes only 15 seconds to correct for a 180° error.

In-Flight

Normally, if the compass is properly slaved before takeoff, no in-flight manual fast slaving is required unless free directional gyro operation is selected. When operating as a free gyro, the desired heading can be established by using the set-heading switch.

NOTE

During manual fast slaving, the autopilot is automatically turned off. About 3 minutes may be required before the autopilot can be re-engaged.

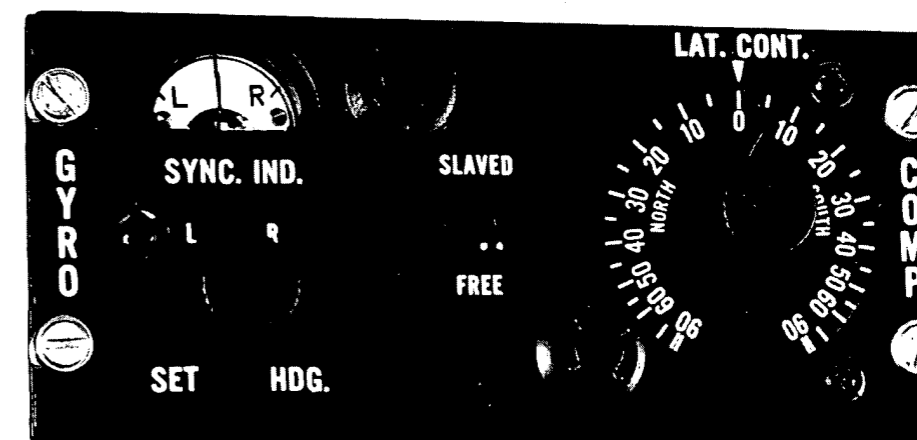

MA-1 COMPASS CONTROLLER

FIG. 4-31

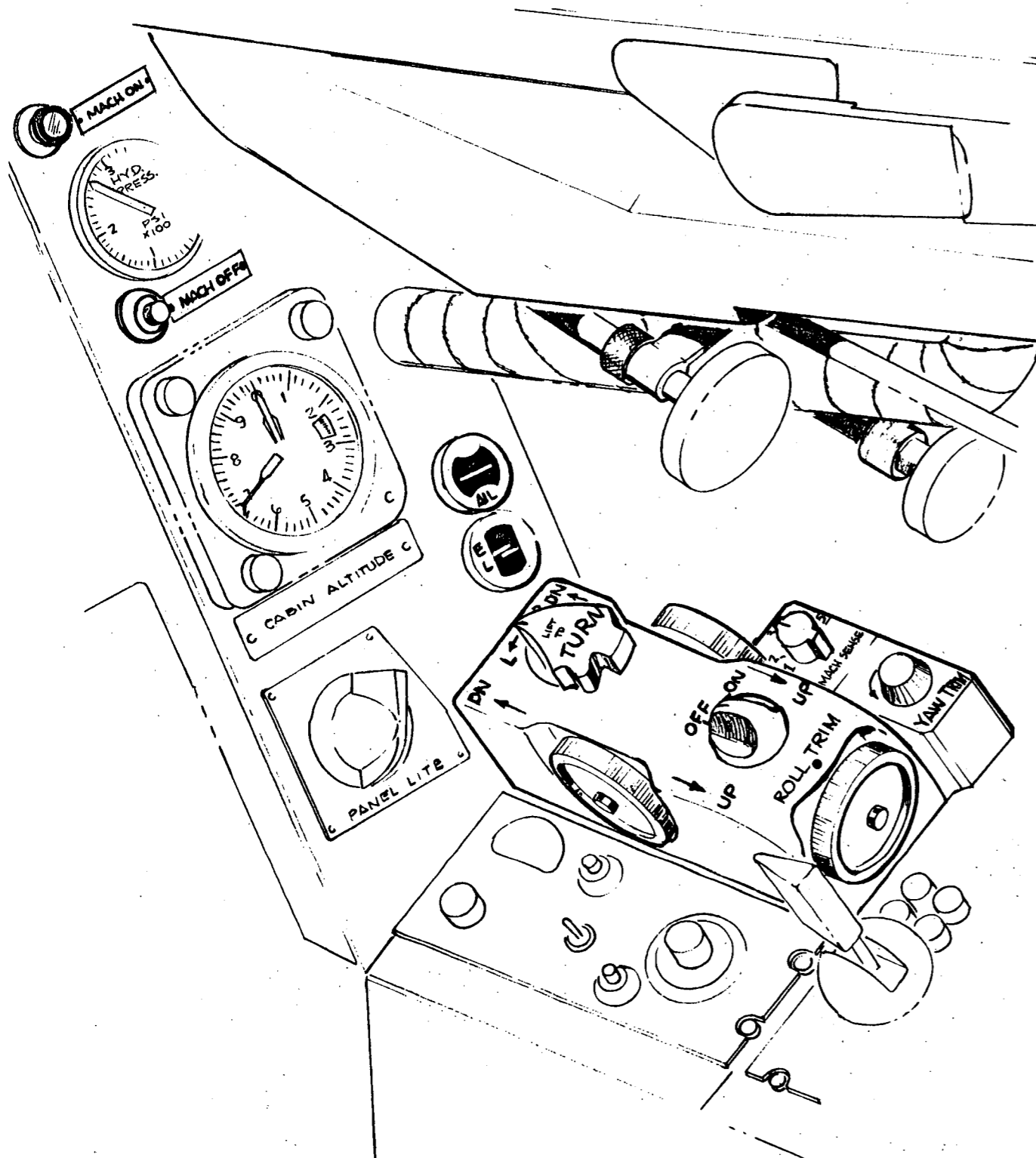

AUTOPILOT FLIGHT CONTROLLER
FIG. 4-32

CONTROLS

MA-1 Compass Control Panel

This panel is located on the right forward console alongside the autopilot controller. Controls are as follows:

1. Slaved-Free Switch - This switch is placed in the SLAVED position to operate as a magnetically slaved system and in the FREE position to operate as an unslaved directional gyro.
2. Latitude Control - This control is used only when operating as a free directional gyro. The lateral control knob is turned to set the existing latitude to the index mark on the panel. This provides electrical compensation for drift caused by the rotation of the earth. When set properly, the gyro spin axis stays fixed relative to the earth and provides a stable directional reference. When operating as a magnetically slaved system, the latitude control is disconnected and may be left at any setting.
3. Set-Heading Switch - The set-heading switch is used to fast slave the gyro. It provides a manual means of rapidly synchronizing the pilot's directional indicator to the correct magnetic heading when the system is in magnetically slaved operation or to set the directional indicator to a desired gyro heading when in free directional gyro operation.

Indicators

1. Directional Indicator - During fast slaving the directional indicator should be observed to establish the proper heading. The indicator card will show immediately whether the set-heading switch is being turned in the proper direction.
2. Synchronization Indicator - The sync. indicator is located above the set-heading switch on the compass control

panel. This indicator can be used in conjunction with the directional indicator during fast slaving. The indicator is very sensitive and it is not necessary to exactly center the needle because the spring loaded set-heading switch, when released, will allow normal slaving to continue until the needle is centered.

The sync. indicator is used only when operating as a magnetically slaved system and is inoperative when on free gyro.

OPERATION

1. Inverter - ON.
2. Slaved-Free Switch - Set for desired operation.
3. Latitude Control Knob - Set to proper latitude when operating on free gyro.
4. Set-Heading Switch - Fast slave directional indicator to proper heading.
5. Sync. Indicator - Center needle when operating as magnetically slaved system.

AUTOPILOT SYSTEM

GENERAL

This aircraft is provided with a Lear 5105A three axis autopilot incorporating electrical servos installed in the airplane control system. These servos are located in the main landing gear bay. The gyros, amplifiers and other necessary units are located in the airplane nose compartment. Directional control is maintained by reference to a remote compass through the MA-1 gyro compass system. Lateral control is provided by a vertical gyro. Longitudinal control can be maintained as a function of attitude as shown by the vertical gyro; however, it is also possible to select control by Mach sensor. This is usually done for altitude cruise.

An automatic pitch trim unit is provided which keeps the airplane in trim longitudinally while the autopilot is engaged. During the time that the autopilot is on, the normal elevator trim switch is inoperative.

and is used for disengaging the Mach hold function without disengaging the autopilot.

CONTROLS

Flight Controller

This unit is located on the right forward console, as shown in Figure 4-32, and has the following controls:

1. On-off switch -- for engaging and disengaging the autopilot.
2. Roll trim wheel -- for aligning the autopilot roll circuits to insure that no trim forces are present when the autopilot is engaged.
3. Pitch trim wheel -- for performing pitch maneuvers and adjusting airplane pitch attitude while the Mach control unit is off.
4. Turn knob -- for making coordinated autopilot turns.

Mach Sensitivity Control

The Mach sensitivity control is located outboard of the flight controller and provides the pilot with a means of varying the sensitivity of the Mach sensor.

Yaw Trim Control

The yaw trim control is located outboard of the flight controller and provides the pilot with a means of adjusting the yaw trim of the airplane through the autopilot system.

Roll Trim Indicator

The roll trim indicator is located on the right forward sub-panel. Before autopilot engagement, the roll trim indicator is active to provide a reference for centering the autopilot roll circuit. After proper autopilot engagement, the indicator shows when the servo units are holding a force in the airplane control system. It does not necessarily show airplane attitude.

Pitch Trim Indicator

The pitch trim indicator is located on the right forward sub-panel directly below the roll trim indicator. The pitch trim indicator is active only after engagement. It shows when the servo units are holding a force in the airplane control system.

Autopilot Disconnect Button

This button is located on the right side of the pilot's control wheel and provides for quick disengagement of the autopilot in an emergency.

Mach ON Button and Light

The Mach ON button and light is located on the right forward sub-panel (Figure 4-32) and is used for engaging the autopilot Mach hold function. Incorporated in the button is an integral light which indicates that the Mach hold function is engaged.

Mach OFF Button

The Mach OFF button is located on the right forward sub-panel below the Mach ON button

PREFLIGHT CHECK PROCEDURE

Turn the power switch to ON. Move the roll trim wheel left and right, observing control

wheel movement. Neutralize the control wheel with the roll trim wheel. Move the pitch trim wheel fore and aft, obtaining full control column travel. Neutralize the control column with the pitch trim wheel. Lift the turn knob out of the detent and turn it full left. Observe that the wheel moves full left. Return the turn knob to the detent and perform the same check, moving the turn knob to the right. Push the Mach ON light and note that the light comes on and that there is no control movement. Push the Mach OFF button and check for light off. Overpower the aileron, elevator and rudder. Release and check that the controls return to their original position. Press the autopilot disengage button on the control wheel and check that the autopilot has disengaged.

IN-FLIGHT OPERATION

Engaging

The autopilot can be engaged at any time after takeoff, providing sufficient warmup and slaving time has been allowed, by turning the engage switch on the flight controller to ON. However, if engagement is made when the airplane is not in a wing-level attitude and/or if the rudder pedals are displaced, the airplane will immediately assume a near wing-level attitude and the rudder will return to a near neutral position. The autopilot will automatically maintain any pitch angle up to $\pm 40^\circ$ and any heading which the aircraft is in at the time of engagement.

In order to engage the autopilot without causing a sudden attitude change in the roll axis, the following procedure should be followed:

1. Manually stabilize the airplane on the desired heading and at the desired pitch attitude with the wings level. Maintain manually stabilized flight for a few seconds.
2. Rotate the roll trim wheel of the flight controller so that the roll trim indicator is faired.
3. Engage the autopilot.

NOTES

1. Monitor the airplane controls during the engagement, being prepared to overpower the autopilot in the event that an autopilot malfunction causes a sudden attitude change.
2. The automatic pilot may be engaged at any airspeed up to 30 knots above the rough air operating limits of the airplane as established in SECTION V.
4. After engagement, release the controls; the flight controller should now maintain the flight attitude which was set in manually.

Trimming

Roll trim should be used only at the initial engagement of the autopilot. It is not necessary or advisable to use roll trim at any other time during flight.

Wings level flight is very important in this aircraft as even slight wing down flight can cause fuel to transfer to the sump tank faster from the high wing, thus aggravating the roll trim condition of the aircraft. Since heading control is maintained through the roll axis, the autopilot will compensate for a directional out-of-trim condition by commanding a bank angle. This situation is undesirable, and is avoidable by using the proper trimming procedures.

Since the rudder of the aircraft cannot be trimmed in flight before engagement of the autopilot, it cannot be assumed that the aircraft is in perfect directional trim before engagement of the autopilot. Since the wings are maintained level before engagement, any slight wing down condition after engagement is due to the autopilot's commanding a bank angle to compensate for this directional out-of-trim condition. Therefore, after engaging the autopilot, the yaw trim control should be adjusted to re-level the wings.

A little extra effort in trimming the aircraft when the autopilot is first engaged will decrease the work load on the pilot, as he will not need to be frequently retrimming the aircraft. Once the initial trim is properly established, it should hold satisfactorily for the duration of the flight.

If the autopilot is allowed to hold one wing high due to improper trimming, uneven fuel transfer will result, as mentioned earlier. The pilot will notice a gradual change in the control wheel position as the autopilot commands more aileron trim necessary to maintain the bank attitude. At this point nothing can be accomplished by adjusting the autopilot roll or yaw trim controls. Disengage the autopilot, transfer fuel to balance the aircraft, re-engage the autopilot, and retrim more carefully.

A drifting or slaving directional gyro will also cause the aircraft to become out of trim.

The following procedure should be used for trimming the aircraft for autopilot operation:

- a. Before engaging autopilot, trim aircraft manually in pitch and roll with wings level.
- b. Rotate roll trim wheel to center the roll trim indicator.
- c. Engage autopilot and put the flight controller turn knob just out of detent on either side of the detent. Make sure that this positioning of the turn knob does not cause any change of roll attitude.
- d. Adjust the roll trim wheel to level the wings.
- e. Put turn knob back in detent.
- f. Observe bank attitude for at least one minute to see if it is holding steady.
- g. If a wing drops, it indicates that rudder is being held in to the high wing and the autopilot is counteracting it with a bank in the opposite direction. It should be corrected for by adjusting yaw trim into the low wing and not by chasing the wing down condition with roll trim.
- h. The optimum condition to achieve is wings level flight with the turn knob

in or out of detent. If a rudder trim change is made, a slight readjustment of roll trim may be necessary. The optimum trim condition, when once established, should give a stable platform for the flight duration.

Straight Flight

In normal straight flight on autopilot, a minimum of pilot effort is required other than monitoring the airplane controls when near the ground or other aircraft. Occasional, brief, transient disturbances may be experienced. As an electronic device, the autopilot is subject to slight transients as a result of sudden changes in supply voltages. Such transients may be noticed when turning other electrical equipment on or off.

Check the airplane for constant heading. If the autopilot is not holding heading it may be due to:

- a. Slaving action of the autopilot gyro.
- b. Failure of either the MA-1 compass or the autopilot's directional gyro.
- c. Excessively low slip clutch settings in roll.

Turn Control

Coordinated turns with a bank angle up to 25 ± 5 degrees are made with the flight controller turn knob. The knob is lifted out of detent and rotated to fly the airplane into the turn, and rotated back to its center position but held up out of detent until the wings are level to recover from the turn. The knob may be turned as rapidly as desired, consistent with structural limitations and pilot comfort.

Pitch Attitude Control

Pitch attitude is maintained through the autopilot by one of two controls. The pitch command knob or the Mach control as activated by the Mach ON button.

a. Pitch Command Knob

The pitch command knob provides control of dives and climbs through a range of $\pm 40^\circ$ from horizontal flight. The knob may be rotated as rapidly as desired, consistent with structural limitations and pilot comfort. Automatic pitch synchronization insures that the knobs will be at neutral position whenever the autopilot is engaged. The command knob is used to establish the pitch attitude so as to obtain proper climb, level flight or descent performance. In the event of Mach control failure, it can be used to maintain the Mach schedule.

NOTE

The pitch command knob does not move during synchronization; neutralizing is by means of a differential arrangement inside the flight controller.

b. The Mach Control

The Mach control is engaged by pressing a dimable lighted push button switch on the right instrument panel that illuminates when the Mach hold function is engaged. The Mach control, when engaged, controls the pitch attitude of the aircraft to maintain the Mach number that existed at the time of engagement. The pitch attitude, while on Mach control is a function of the thrust. If the thrust is decreased, the nose will lower and if it is increased, the nose will raise. Any thrust in excess of that required to maintain level flight will cause a climb to the level where the thrust and drag will balance to give level flight. Disengagement of the Mach Hold function is accomplished by pushing the Mach OFF button. This returns pitch attitude control to the command knob of the flight controller. Mach control is also turned off whenever the autopilot is disengaged.

Gust-Faired Operation

It is necessary for the autopilot to operate around a constant surface reference in order to maintain stable control. Therefore, it has two follow-up systems, one using the flaps faired position as its reference and the other using the flaps gust position. In order to prevent roll transients while shifting between these flaps positions, the autopilot is automatically disengaged during the shift. The autopilot may be re-engaged as soon as the shift is completed.

Overpowering

Each autopilot servo unit incorporates a slip-clutch device which limits the servo output to a level readily overpowered by the human pilot. This enables the pilot to resume manual control of the aircraft before a dangerous flight attitude can occur should some part of the autopilot malfunction.

CAUTION

When in autopilot flight in close proximity to the ground or to other aircraft, the airplane controls should be closely monitored.

Overpower the autopilot whenever necessary in an emergency. No damage to the autopilot will result. When overpowering the pitch function, the force should be released as soon as possible, for continuous overpowering will result in the aircraft's becoming badly out of manual trim. If subsequent disengagement is necessary while in this out of trim condition, a sudden attitude change may result.

CAUTION

Do not overpower the autopilot to maneuver the airplane or to increase the autopilot's attitude limits.

Disengaging

The autopilot will be disengaged and/or recycled by any of the following six actions:

- Pressing the autopilot disconnect button on the control wheel.
- Turning the on-off switch on the flight controller to OFF.
- Operation of the faired-gust switch in either direction.
- Turning off the inverter *
- Switching off the aircraft battery switch *
- Manipulation of the MA-1 set-heading switch *

* Items d, e, and f recycle the autopilot into a time delay period. Thus it will be impossible to turn the autopilot back on for 2 to 3 minutes.

NOTE

Regardless of the method used to disengage the autopilot, the on-off switch on the flight controller will return to OFF.

When disengaging the autopilot, it is advisable to monitor the cockpit controls in case the autopilot pitch trim has not completely retrimmed the airplane or has failed to function normally.

LONGITUDINAL TRIM MALFUNCTIONS

There are three conditions which are commonly called "runaway trim".

- True runaway trim is that condition in which the airplane abruptly pitches up or down due to a continuous signal to the airplane trim tab actuator. The control forces will indicate a deflected (up or down) elevator trim tab. A recent autopilot modification (interlock wiring) has been incorporated to prevent this occurrence while on autopilot.

Should the aircraft trim tab actuator relay malfunction, there is still a possibility of a runaway tab.

If a runaway trim is suspected, due to a pitch transient, the pilot should disengage the autopilot and attempt to manually retrim to level flight.

CAUTION

Closely monitor the control wheel upon disengaging autopilot, as large pitch transients will occur.

If the aircraft trim is inoperative, the flight may be aborted.

If the aircraft trim is operative, the pilot should manually retrim to level flight condition, turn the trim power switch OFF, re-engage the autopilot and continue the flight using the flight controller pitch command wheel for attitude control. Repeat this process every 30 minutes for the balance of the flight.

- False runaway trim is that condition in which the airplane, while on autopilot pitches up or down due to an erroneous signal from the autopilot elevator servo control. After disengaging the autopilot, the airplane elevator control forces will return to normal and the pilot may resume normal level flight easily. This condition has no in-flight fix and the mission must be "hand flown" for the remainder of the flight.
- Another false runaway trim indication may be found if, during cruise, the auto pitch trim has become inoperative and is not noticed. During the descent on autopilot, as altitude is decreased and speed is increased, the autopilot will be unable to apply sufficient force to maintain the descent schedule. The first indication of malfunction will be a deviation from

AUTOPILOT TROUBLE SHOOTING CHART		
Trouble	Probable Cause	Fix
Unable to turn autopilot ON	<ol style="list-style-type: none"> Circuit breakers out. Inverter OFF or inoperative. Generator OFF or inoperative. "Turn Knob" out of detent. Autopilot disengage switch on wheel stuck. Time delay period has not elapsed. If all of the above are OK 	<ol style="list-style-type: none"> Reset Gust Control & Inverter Control circuit breakers. Check inverter. Check generator. Return knob to detent. Check switch. Wait 3 to 4 minutes, try again. Make entry in DD 781 upon return.
Unable to center roll trim indicator prior to engagement.	<ol style="list-style-type: none"> Indicator sticky. Vertical autopilot gyro not fully erected. If still inoperative. If still inoperative. 	<ol style="list-style-type: none"> Tap indicator lightly. Recycle autopilot system by turning inverter off and on. Observe 3 minute time delay period. Monitor controls closely and engage autopilot, trimming after engagement per normal procedure. Make entry in DD 781 upon return.
Pitch change upon engagement.	<ol style="list-style-type: none"> Pitch synchronization failure. 	<ol style="list-style-type: none"> Manipulate Pitch Command Wheel to relieve control wheel forces. In any case, make entry in DD 781.
Excessive dead bank in Pitch Command Wheel.	<ol style="list-style-type: none"> Autopilot amplifier setting improper. 	<ol style="list-style-type: none"> Make entry in DD 781 upon return.
Pitch attitude change upon initial engagement of Mach Sensor.	<ol style="list-style-type: none"> Mach sensor amplifier out of adjustment. 	<ol style="list-style-type: none"> No in-flight fix. Make entry in DD 781 upon return.
No Mach Hold light after pressing button.	<ol style="list-style-type: none"> Bulb burned out if Mach hold function is operative. 	<ol style="list-style-type: none"> Make entry in DD781 upon return.
Mach Hold allows pitch and altitude oscillations.	<ol style="list-style-type: none"> Improper Mach Sensor adjustments. 	<ol style="list-style-type: none"> No in-flight fix. Make entry in DD 781 upon return.

FIG. 4-33(a)

Trouble	Probable Cause	Fix
Mach Hold allows indicated air-speed to creep above or below climb schedule.	1. Improper Mach Sensor adjustments.	1. No in-flight fix. Make entry in DD 781 upon return.
Wheel jump and/or pitch attitude change on disengaging Mach Sensor	1. Out of synchronization with Pitch Command Wheel (usually small transient). 2. Mach sync. motor control improperly set (larger transients).	1. Normal if Mach change occurred just prior to disengaging. 2. Make entry in DD 781 upon return.
Runaway elevator trim tab while on autopilot.	1. Improper slip clutch setting in pitch servo.	1. Make entry in DD 781 upon return.
Oscillations in any, or all axes.	1. Improper autopilot amplifier settings.	1. Temporary fix - Apply slight overpower or dampening manual force for short periods. Make entry in DD 781 upon return, specifying axes involved and amplitudes.
Unable to obtain optimum, or equal, bank angles with Turn Knob.	1. Improper autopilot amplifier settings.	1. No in-flight fix. Make entry in DD 781 upon return.
Wing drops as Turn Knob is lifted straight up out of detent.	1. Aircraft out of trim. 2. Autopilot out of trim.	1. Disengage autopilot. Check for wing heaviness due to uneven fuel. Transfer fuel if necessary. Observe ball for yaw trim. If off more than 1/8 ball, make entry in DD 781. 2. Re-engage autopilot. Re-trim per In-flight Autopilot Trimming Procedure. Pay particular attention to yaw trim.
Wheel jump and/or pitch attitude change upon disengaging autopilot.	1. Trim tab power switch on left of wheel turned OFF. 2. Trim tab circuit breaker out. 3. Automatic pitch trim tab control inoperative.	1. Turn switch ON. 2. Reset circuit breaker. 3. Make entry in DD 781 upon return.

FIG. 4-33(b)

SECRET

descent scheduled air-speeds, a pitch trim indicator deflection and eventual servo clutch slippage with resultant pitch change. The pilot should disengage the autopilot and manually trim the airplane.

CAUTION

Closely monitor the control wheel upon disengaging the autopilot as large pitch transients may occur.

NOTE

Momentary sticking relays most frequently cause auto trim failure. This condition may be corrected by disengaging and re-engaging the autopilot.

The pitch trim indicator is not accurate enough to give the pilot any more than a general indication of the unbalance loads within the autopilot pitch control system. Whenever the pilot is in doubt concerning autopilot loads or servo clutch slippage, he should closely monitor the controls, disengage the autopilot and determine manually if such loads exist.

MISCELLANEOUS EQUIPMENT

PITOT HEAT SWITCH

Pitot heat switch located on the forward panel to the right of the ignition switch.

CHECK LIST

A pilot emergency check list is mounted on the forward part of the sunshade within a plastic cover. A pre-landing check list is located on the center of the control wheel.

MAP CASE

The map case is located to the rear of the left console. This map case has no cover.

RELIEF TUBE

A conventional horn type relief tube is provided in this aircraft. It is located in a recess at the bottom of the left console panel. To use this tube it is necessary to pull it out in a motion level with the floorboard and forward. The tubing is arranged so that it is spring loaded back into the recess and automatically retracts when not in use.

NOTE

If the relief tube is used in flight, it is necessary to make an entry in the DD 781 Part 2. This is required so that the collection bottle located below the floorboards may be drained by the ground crew. There is a drain cock in the equipment bay.

REAR VIEW MIRRORS

There are two swivel mounted rear view mirrors located on each side canopy post.

RUBBER CONE

A rubber cone is provided to attach to the display scope. This serves two purposes. First it keeps out stray light when using the sextant. Second it provides a known place in space for properly positioning of the pilot's head to facilitate using the sextant and drift sight systems. This is normally stored in the map case when not in use.

WINDSHIELD SWAB

A windshield swab is provided with the aircraft. It is usually stored in the forward canopy to the right or left of the scope. This swab consists of absorbant cloth fixed to an 18 inch stick, and is used for cleaning the windshield side panels in flight.

SUN SHADE

All aircraft are supplied with a moveable sun shade. This sun shade is located on the canopy and is fastened so that it may be moved from side to side in a channel molding.

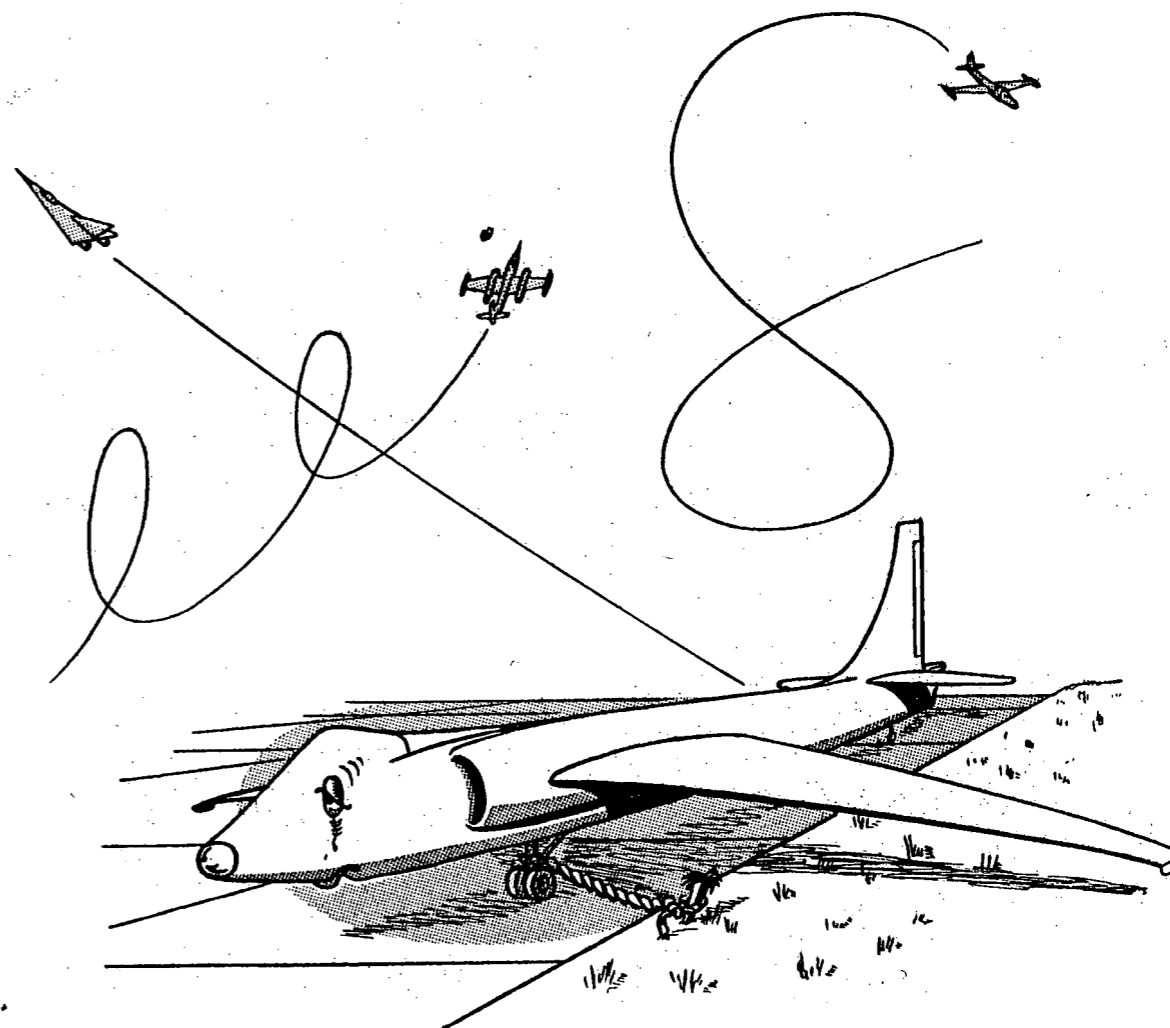

TABLE OF CONTENTS

	PAGE
GENERAL.....	5-2
J57 - P-31 ENGINE LIMITATIONS.....	5-2
INSTRUMENT MARKINGS.....	5-3
J57 - P-37 ENGINE LIMITATIONS.....	5-4
PROHIBITED MANEUVERS.....	5-5
AIRSPPEED LIMITATIONS.....	5-5
GUST CONTROL LIMITATIONS.....	5-5
ACCELERATION LIMITATIONS.....	5-9
JP-4 FUEL LIMITATIONS.....	5-9
LIMITATIONS WITH SLIPPER TANKS INSTALLED...	5-9
WEIGHT & BALANCE LIMITATIONS.....	5-9

5
SECTION



OPERATING LIMITATIONS

GENERAL

This airplane was designed for a specific mission and has performance capabilities in certain categories exceeding anything previously available. In order to meet these requirements, it was necessary to impose very definite structural and aerodynamic limitations. Therefore, it should only be flown in a manner required to accomplish the basic mission. If this fact is remembered by the pilot, he should have no difficulty staying within the placard limitations.

The airplane has received extensive static load tests, flight tests and operational experience. Safe flight limitations were established and demonstrated in flight.

J57-P-31 ENGINE LIMITATIONS

SPEED

Approximately 96% for military power, depending on engine rating.

OVERSPEED

102% Maximum.

EXHAUST GAS TEMPERATURE

Normal Operation

590°C. Maximum below 35,000 feet.
610°C. Maximum above 35,000 feet.

NOTE

During a normal climb, above 35,000 feet, the engine is operated at an exhaust gas temperature of 610°C. If a lower temperature is used, climb performance will be correspondingly reduced.

Starting

610° Maximum.

Acceleration

660° C. Maximum.

CAUTION

Overtemperature conditions should be corrected immediately and recorded in DD Form 781 giving temperature and endurance. If condition cannot be corrected, a landing should be effected as soon as possible.

OIL PRESSURE *see Tech Data Change FM-6*

Normal operating oil pressure range is 40-50 psi. Oil pressures between 35 and 40 psi are undesirable and should be recorded in DD Form 781. Pressures below 35 or above 55 psi are unsafe, and the engine should be operated at the lowest RPM that will sustain flight, and a landing made as soon as possible. Minimum oil pressure at idle RPM during ground operation is 35 psi.

FUEL PRESSURE

Normal range is 14-21 psi. Momentarily drops to 8 psi or lower during full power takeoff.

POWER REGULATION AT ALTITUDE

The primary engine operating variables are exhaust gas temperature and pressure ratio. Above 35,000 feet, throttle position is varied in order to keep the exhaust gas temperature at the 610°C limit. During the cruise climb the pressure ratio will gradually decrease and may reach a minimum allowable value. It is then necessary to increase speed and lose altitude as outlined in SECTION II, "Altitude Control". Pressure ratios above the maximum (or below the minimum)

see FM-6

AIRSPPEED INDICATOR

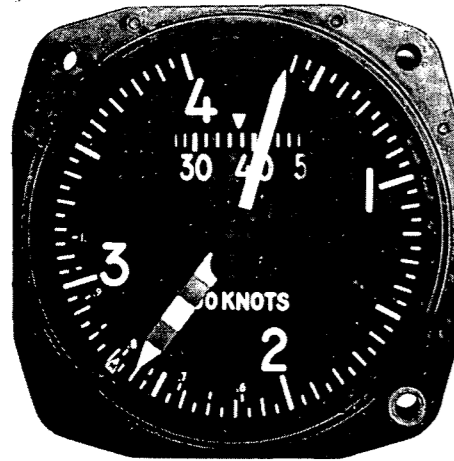

INSTRUMENT MARKINGS

TACHOMETER

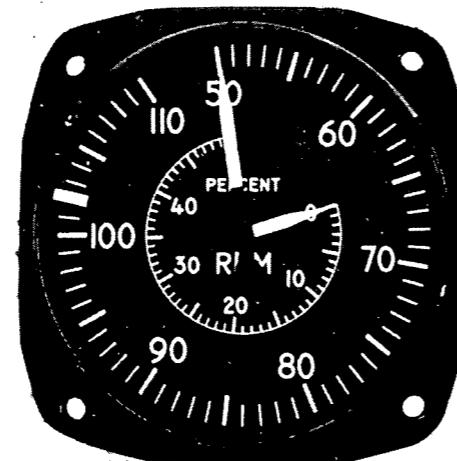

THE INSTRUMENT SETTING IS SUCH THAT THE STRIPED POINTER WILL MOVE TO INDICATE THE LIMITING STRUCTURAL AIR SPEED OF 260 KNOTS, OR THE AIR SPEED REPRESENTING THE LIMITING MACH NUMBER OF 0.8, WHICHEVER IS LESS

102% MAXIMUM OVERSPEED

EXHAUST GAS TEMPERATURE

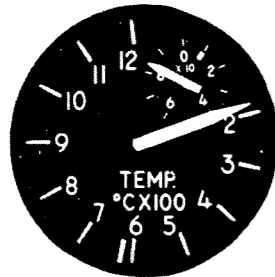

P-31 ENGINE - 610°C. MAX, ABOVE 35,000 FT.

NOTE

P-37 ENGINE - 640°C. MAX, ABOVE 35,000 FT.



FUEL PRESSURE

21 PSI MAXIMUM
14 - 21 PSI NORMAL
8 PSI DURING FULL POWER TAKE-OFF

OIL PRESSURE

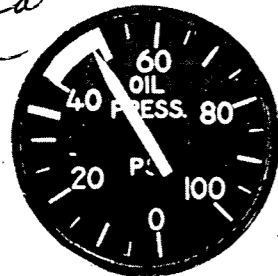

40 - 50 PSI NORMAL
35 PSI MINIMUM

LOADMETER

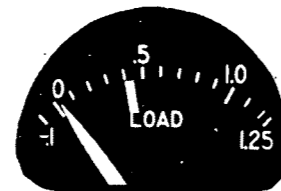

0.1 - 0.2 NORMAL
0.4 MAXIMUM



HYDRO PRESSURE

2850 - 3150 PSI NORMAL
3500 PSI MAXIMUM

FIG. 5-1

should be avoided due to the possibility of compressor stall and flameout.

The pressure ratio limits are as follows:

ALT.	P. R. MAX.	P. R. MIN.	EGT (°C) MAX.	CLIMB SPEED KTS
35	-	-	590°	160
40	-	-	610°	160
50	3.24	-	610°	160
55	3.24	-	610°	150
60	3.22	2.00	610°	135
62	3.20	2.15	610°	130
64	3.18	2.25	610°	124
66	3.14	2.40	610°	118
68	3.09	2.50	610°	112
70	3.02	2.50	610°	108
72	2.93	2.50	610°	104

Minimum fuel flow is set low enough so that it normally will not be encountered. To avoid the possibility of flameout during descent, the minimum P. R. limits should be closely observed.

Starting

610°C maximum.

Acceleration

660°C maximum.

*see FM-6
Tech Data Change*

OIL PRESSURE

40 - 50 psi. Normal.

35 - 40 psi. Undesirable, report in DD Form 781.

Below 35 psi or above 55 psi - Unsafe.

The engine should be operated at the lowest RPM that will sustain flight and a landing made as soon as possible.

FUEL PRESSURE

14 - 21 psi - Normal. Momentarily drops to 8 psi or lower during full power takeoff.

POWER REGULATION AT ALTITUDE

The primary engine operating variables are engine speed, exhaust gas temperatures, and pressure ratio. The following limits should be carefully observed at altitudes above 50,000 feet in order to avoid engine compressor stall and possible flameout.

NOTE

When throttling to the above limits, throttle movement should be very slow as P. R. response is sluggish.

J57-P-37 ENGINE LIMITATIONS

SPEED

Approximately 94% for military power, depending on engine rating.

OVERSPEED

102% maximum.

EXHAUST GAS TEMPERATURE

Normal Operation

610°C maximum below 35,000 feet.

610°C maximum above 35,000 feet.

<u>ALT.</u>	<u>MAX. RPM</u> (Very Important)	<u>P. R.</u> <u>MAX.</u>	<u>EGT (°C)</u> <u>MAX.</u>	<u>CLIMB</u> <u>SPEED KTS.</u>
35	--	--	610°	160
40	--	--	640°	160
50	90	--	640°	160
55	89	--	640°	150
60	88	3.07	640°	135
62	NOT	3.02	640°	130
64	APPLICABLE	2.98	640°	124
65	ABOVE	2.95	640°	121
66	60,000	2.92	640°	118
67	FEET	2.90	640°	115
68		2.87	640°	112
69		2.84	640°	110
70		2.82	640°	108

For descent the power lever can be slowly retarded to the idle position, regardless of altitude.

The minimum fuel flow is adjusted to approximately 750 lbs./hour. An altitude may be reached at which this minimum full flow equals that required for maximum exhaust gas temperature. In this case retarding the throttle to idle will not change the power condition. The flight may be continued at constant altitude. In the event that the maximum EGT is exceeded, it can be reduced by losing altitude and increasing airspeed as outlined in SECTION II, "Altitude Control".

PROHIBITED MANEUVERS

All acrobatic maneuvers are prohibited.

AIRSPEED LIMITATIONS

The airspeed limitations are shown in the table below. These limitations were demonstrated in flight and must not be exceeded. The airspeed indicator maximum allowable needle is set for 0.80 Mach number or 260 knots, whichever is less. These limitations must be observed.

CONFIGURATION MAX. ALLOWABLE
see Tech Detail Change AIRSPEED

<i>FM-2</i> SMOOTH AIR	
Faired	220 Knots
Gust Control On	260 Knots
ROUGH AIR	
Faired	150 Knots
Gust Control On	170 Knots
GENERAL	
Landing Gear Extended	260 Knots
Wing Flaps Extended	130 Knots
Speed Brakes Extended	260 Knots

WARNING

Never extend the wing flaps above 45,000 feet since dangerous pitching moment effects are produced.

GUST CONTROL LIMITATIONS

When actuating the gust control from the GUST position to the FAIRED position, there is a remote possibility that the flaps might continue down. Since this type of malfunction

FLIGHT STRENGTH DIAGRAM

13,700 LB. GROSS WEIGHT
WITH OR WITHOUT SLIPPER TANKS

NOTE:

Gust lines shown on diagram are equivalent maneuvering load factors.

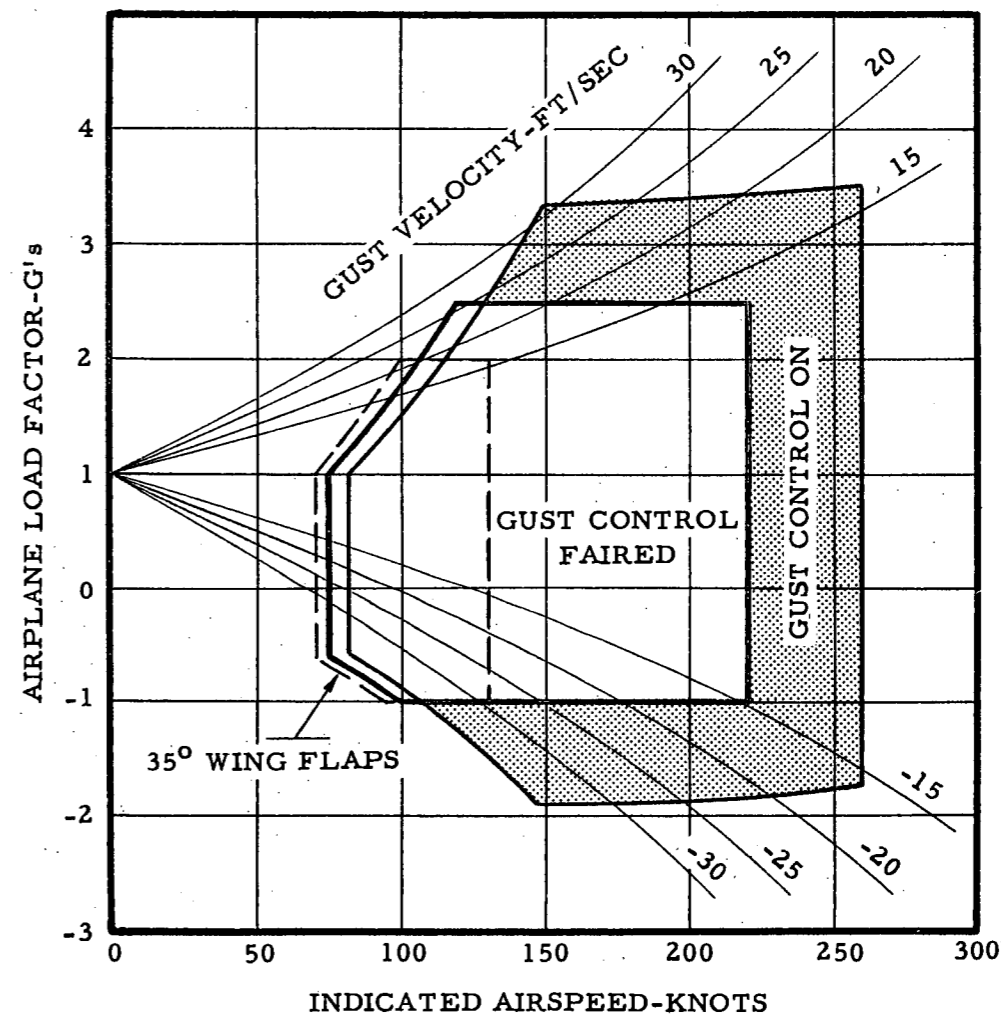

FIG. 5-2

FLIGHT STRENGTH DIAGRAM

17,300 LB. GROSS WEIGHT
WITH OR WITHOUT SLIPPER TANKS

NOTE:
Gust lines shown on diagram
are equivalent maneuvering
load factors.

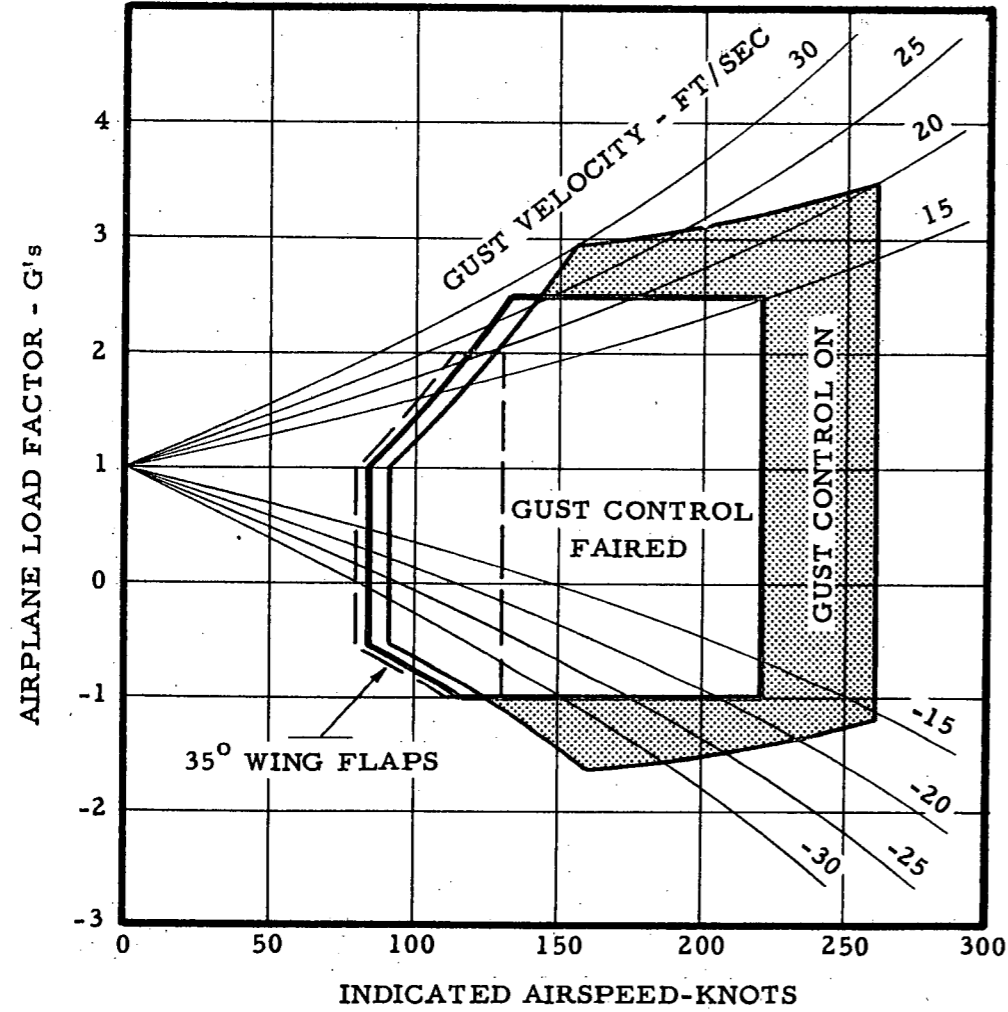

FIG. 5-3

FLIGHT STRENGTH DIAGRAM

20,000 LB. GROSS WEIGHT
WITH OR WITHOUT SLIPPER TANKS

NOTE:
Gust lines shown on diagram
are equivalent maneuvering
load factors.

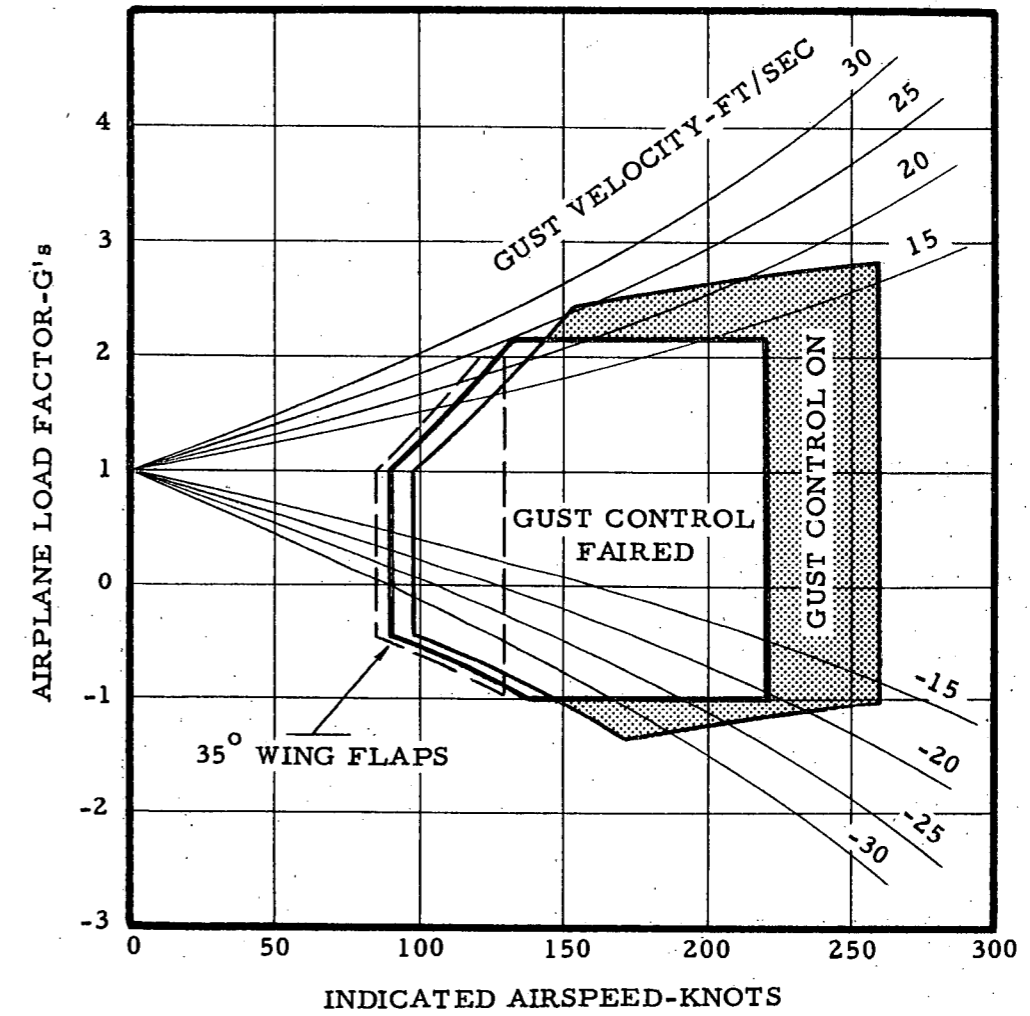

FIG. 5-4

could be hazardous, the gust control should not be actuated from GUST to FAIRED until the aircraft is slowed to 160 knots or slower.

The gust control should not be actuated from FAIRED to GUST at airspeeds above 220 knots. Since this is the placard speed for the FAIRED configuration, this condition will not normally arise. However, should the aircraft reach a speed in excess of 220 knots in the FAIRED configuration, the speed should be dissipated as carefully as possible.

ACCELERATION LIMITATIONS

The aircraft has a limited "G" capability as shown in the flight strength diagrams. In some configurations the maximum load factors are plus 2.0 and minus 1.0. Since there is no accelerometer in the cockpit it is of primary importance that the pilot handle the aircraft in such a manner as to avoid placing high load ("G") factors on it. Because of these restrictions the aircraft is generally never banked over sixty degrees.

INSTRUMENT MARKINGS

Cognizance must be taken of the instrument markings as shown on Figure 5-1, since they represent limitations that are not necessarily repeated elsewhere.

JP-4 FUEL LIMITATIONS

In an emergency, JP-4 fuel may be used for low altitude work or for ferry flight. Extreme caution must be exercised as the fuel system was not designed for fuels with higher vapor pressure. Excessive pressures can be developed in the wing tanks through high rates of climb or high altitude.

WARNING

With JP-4 fuel, the rate of climb must be kept down to 2000 feet per minute by using approximately 85% engine RPM. The maximum allowable altitude is 50,000 feet. If these limits are not observed, structural failure may result.

When observing the above limits, there is negligible slugging or venting of fuel overboard.

Cruise and range data given in the APPENDIX will apply.

OPERATING LIMITATIONS WITH SLIPPER TANKS INSTALLED

The addition of slipper tanks does not change the aircraft limitations.

WEIGHT AND BALANCE LIMITATIONS

The variation of center of gravity position with fuel usage is shown in Figure 5-5. These curves are based on extensive study and testing to determine the position of partial fuel loads in the long wing of this aircraft. The two curves represent the forward and aft permissible service loadings. As may be seen, these loadings permit flight between a forward center of gravity position of 23% MAC and an aft center of gravity position of 28.8% MAC. However, for convenience and safety, the center of gravity limitations are specified at zero fuel weight and are 25% and 28% MAC gear down. As long as the aircraft loading is such that the zero fuel weight center of gravity location falls within these limits, then the loading is satisfactory with any amount of fuel. Considerable flying has been accomplished forward and aft of these loadings; however, for optimum flight characteristics it is considered advisable to impose these limits.

A typical loading which follows the forward line consists of the "B" camera configuration and 60 pounds of tail ballast. A loading which follows the aft line consists of the F-2 Foil with no tail ballast.

CAUTION

1. Do not allow the airplane to be misloaded at partial fuel loads. For instance, a loading which results in a c. g. position of 27% MAC at a fuel quantity of 785 gallons is an improper loading.
2. Ballast is provided in the aft section of the fuselage to accommodate various equipment configurations. If items of equipment are not installed or have been replaced with lighter equipment, it may be necessary to remove a part of the tail ballast or add ballast in the nose in order to place the c. g. position within proper limits.

The charts listed below show the various combinations of equipment and the resulting weight and balance conditions of a particular group of airplanes. As noted, there are a few combinations which require special treatment to insure that the center of gravity positions fall within limits.

FIG. 5-6 & 5-7 - Slipper Tank Airplanes With System VI.

FIG. 5-8 - Basic Mission Airplanes.

FIG. 5-9 - AFSWP Nose Airplanes.

FIG. 5-10 - Radar Airplanes.

The tabulations presented as FIG. 5-11 and FIG. 5-12 show the capability of certain serial number aircraft to carry various equipment.

1973 A/D

GROSS WEIGHT - C.G. VARIATION

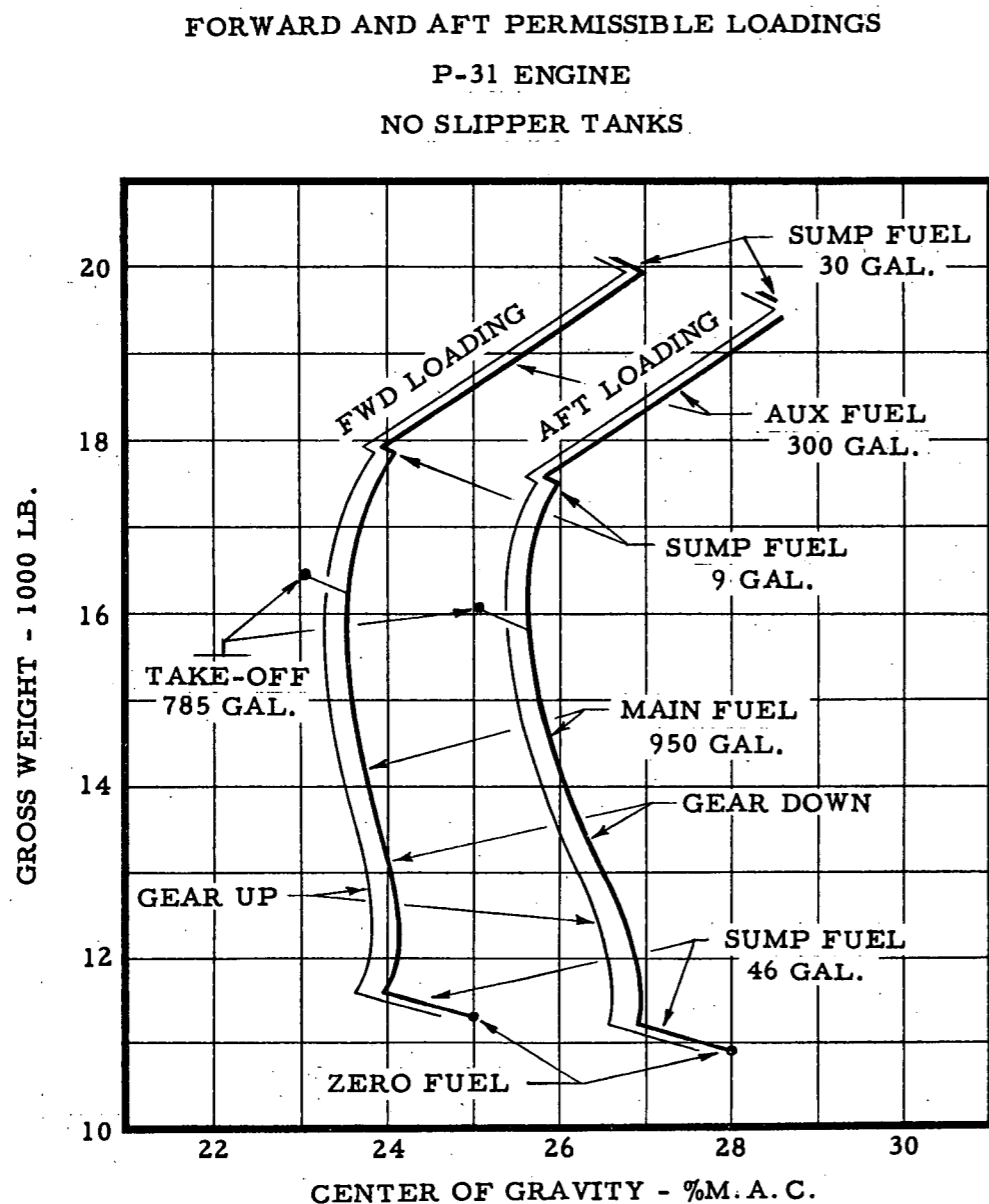

FIG. 5-5

U-2 TYPICAL EQUIPMENT BAY LOADINGS WITH SLIPPER TANKS & SYSTEM VI

BASIC AIRPLANE WEIGHT: 10,739 Lb. @ F.S. 422.6 (Gear Down). This includes the -31 Engine @ 3630 Lb., Pilot's Ejection Seat, Pilot, Slipper Tanks, Residual Fuel and Oil, Engine Oil, Oxygen, Exterior Paint, no Pogos, Provisions for System VI @ 13 Lb., Drag Chute, and all Service Bulletins through #372.

PACKAGES	PACKAGE WEIGHT	BASIC PHOTO				PHOTO & SYSTEM VI			
		A1	A2	B	B OVER-LOAD	A1	A2	B	B OVER-LOAD
Glockenspiel	450								
Destructor	10	X	X	X	X	X	X	X	X
Drift Sight-MK III Control	38	X	X	X	X	X	X	X	X
Sextant	15	X	X	X	X	X	X	X	X
Tracker Camera	58	X	X	X	X	X	X	X	X
A1 Camera	352	X				X			
A2 Camera	364		X				X		
A Camera Basic Hatch - Δ Weight	61	X	X						
A Camera Hatch and Syst. VI Equip. - Δ Weight	71					X	X		
B Camera	420			X	X			X	X
B Camera Overload Magazine	72				X				X
B Camera Basic Hatch - Δ Weight	53			X	X				
B Camera Hatch and Syst. VI Equip. - Δ Weight	92							X	X
Tape Recorder-Map Case	3	X	X	X	X	X	X	X	X
System I	17	X	X	X	X	X	X	X	X
System III-Cheek Instal.	44	X	X	X	X	X	X	X	X
System IV	624								
System VI-Ventral Antenna	85					X	X	X	X
TOTAL PACKAGE WEIGHT		598	610	658	730	676	688	765	837
Zero Fuel Wt. (No Ballast)		11337	11349	11397	11469	11415	11427	11504	11576
C.G. - % MAC		25.2	25.3	24.6	23.8	24.9	25.0	23.9	23.1
Basic Ballast On Ring F.S. 673 (S.B. 304)		60	60	60	60	60	60	60	60
Zero Fuel Wt. (With Ballast)		11397	11409	11457	11529	11475	11487	11564	11636
C.G. - % MAC (With Ballast)		26.6	26.2	26.0	25.1	26.2	26.3	25.2	24.4 ^(a)

(a) Airplane must not be flown in this condition. If necessary to use; remove ejection seat. C.G. then becomes 25.3%.

FIG. 5-6

U-2 TYPICAL EQUIPMENT BAY LOADINGS WITH SLIPPER TANKS & SYSTEM VI

BASIC AIRPLANE WEIGHT: (Same as for FIG.5-6, on facing page.)

PACKAGES	PACKAGE WEIGHT	SYST. IV	F-2 FOIL	F-2 FOIL & P-2 PLAT-FORM	U. S. MULE		FERRY	WEATHER PACKAGE	
					EMPTY	LOAD-ED		S. B. 295	NACA
Glockenspiel	450						X		
Destructor	10	X	X	X	X	X		X	X
Drift Sight-MK III Control	38	X	X	X	X	X		X	X
Sextant	15	X	X	X	X	X		X	X
Tracker Camera	58	X	X	X	X	X		X	X
Tape Recorder-Map Case	3	X	X	X	X	X		X	X
System I	17	X	X	X	X	X			X
System III-Cheek Instal.	44	X	X	X	X	X			X
System IV	624	X							
F-2 Foil	171		X	X					
P-2 Platform	411			X					
U. S. Mule	183				X	X			
U. S. Mule-Useful Load	300					X			
Weather Package (SB-295)	623							X	
NACA Weather Package	302								X
TOTAL PACKAGE WT.		809	356	767	368	668	625	747	487
Zero Fuel Wt. (No Ballast)		11,548	11,095	11,506	11,107	11,407	11,364	11,486	11,226
C. G. - % M. A. C.		22.9	28.1	23.6	28.0	24.5 ^c	24.9	23.5	26.5
Basic Ballast On Ring F. S. 673 (S. B. 304)		60	60	60			60	60	60
Additional Ballast Req. (In Chute Compartment)		100 ^b						100 ^b	
Zero Fuel Wt. (Ballasted)		11,708	11,155	11,566			11,424	11,636	11,286
C. G. - % M. A. C. (With Ballast)		26.5	29.5 ^d	25.0			26.2	27.1	27.9

(b) Additional ballast (Dwg. F614) must be installed in the drag chute compartment in lieu of the drag chute,

(c) Permissible for this configuration. Pilot must be notified of condition.

(d) Airplane must not be flown in this condition. If necessary to use; add 120 Lb. ballast to the F-2 Foil hatch at F. S. 280. C. G. then becomes 28.0%.

FIG. 5-7

U-2 BASIC MISSION EQUIPMENT BAY LOADINGS

BASIC AIRPLANE WEIGHT: 10,541 Lb. @ F. S. 422.9 (Gear Down). This includes the -31 Engine @ 3630 Lb., Pilots Ejection Seat, Pilot, No Slipper Tanks or Pogos, Residual Fuel & Oil, Engine Oil, Oxygen, Drag Chute, and all Service Bulletins through #372.

PACKAGES	PACKAGE WEIGHT	PHOTO				F-2 FOIL	F-2 FOIL & P-2 PLAT-FORM	FERRY
		A1	A2	B	B OVER-LOAD			
Glockenspiel	450							X
Destructor	10	X	X	X	X	X	X	
Drift Sight-MK III Control	38	X	X	X	X	X	X	X
Sextant	15	X	X	X	X	X	X	X
Tracker Camera	58	X	X	X	X	X	X	X
A1 Camera	413	X						
A2 Camera	425		X					
B Camera	473			X	X			
B Camera Overload Magazine	72				X			
System I	17	X	X	X	X	X	X	X
System III-Nose Instal.	44	X	X	X		X		X
F-2 Foil	171					X	X	
P-2 Platform	411						X	
KWM-1 H. F. Transceiver	68	X	X	X	X	X	X	X
TOTAL PACKAGE WEIGHT		663	675	723	751	421	788	690
Zero Fuel Wt. (No Ballast)		11,204	11,216	11,264	11,292	10,962	11,329	11,231
C. G. - % M. A. C.		24.2	24.3	23.6	23.8	27.2	23.6	23.9
Basic Ballast On Ring F. S. 673 (S. B. 311)		60	60	60	60	60	60	60
Zero Fuel Wt. (With Ballast)		11,264	11,276	11,324	11,352	11,022	11,389	11,291
C. G. - % M. A. C. (Ballasted)		25.6	25.7	25.0	25.2	28.5 ^a	25.0	25.3

(a) Airplane must not be flown in this condition. If necessary to use; add 40 Lb. ballast to the F-2 Foil hatch at F. S. 280. C. G. then becomes 28.0 %.

FIG. 5-8

U-2 AFSWP NOSE AIRPLANES - TYPICAL EQUIPMENT BAY LOADINGS

BASIC AIRPLANE WEIGHT: 10,573 Lb. @ F.S. 422.1 (Gear Down). This includes the -31 Engine @ 3630 Lb., Pilot's Ejection Seat, Pilot, No Slipper Tanks or Pogos, Residual Fuel & Oil, Engine Oil, Oxygen, Drag Chute, AFSWP Nose Equipment @ 32 Lb., and all Service Bulletins through #372.

PACKAGES	PACKAGE WEIGHT	P-2 PLATFORM	F-2 FOIL & P-2 PLAT-FORM	FERRY
Glockenspiel	450			X
Destructor (Aft Location)	10	X	X	
Drift Sight-MK III Control	38	X	X	X
Sextant	15	X	X	X
Tracker Camera	58	X	X	X
F-2 Foil	171		X	
P-2 Platform (Loaded)	411	X	X	
KWM-1 H.F. Transceiver & Keyer Provisions.	68	X	X	X
ARA-26 Keyer	5	X	X	X
ARC-12 V.H.F. Transceiver	23	X	X	X
TOTAL PACKAGE WEIGHT		628	799	657
Zero Fuel Wt. (No Ballast)		11,201	11,372	11,230
C.G. - % M.A.C.		25.1	23.1	24.3
Basic Ballast On Ring F.S. 673 (S.B. 303)		80	80	80
Zero Fuel Wt. (With Ballast)		11,281	11,452	11,310
C.G. - % M.A.C. (Ballasted)		26.9	24.9	26.1

The following is a table showing possible equipment loading variations with their accompanying effect on zero fuel weight and center of gravity location. The table applies to FIG. 5-6 through 5-10.

VARIATION	WEIGHT CHANGE -LB-	C.G. SHIFT -% M.A.C. -	
		FWD.	AFT
Retract Landing Gear	-	0.34	
Remove Drag Chute	-11	0.27	
Basic Pilot's Seat in lieu of Ejection Seat	-54		0.86
MK I or II Drift Sight Control in lieu of MK III.	/9	0.15	
J57-P-37 Engine in lieu of the -31.	/474	0.20	
System IV Ram's Horn Antenna in lieu of Ventral Antenna. **	/15		0.17
Remove Slipper Tanks **	/135		0.26

**Applies to FIG. 5-6 & 5-7 only.

FIG. 5-9

U-2 RADAR AIRPLANES - EQUIPMENT BAY LOADINGS

ASN-6 AIRPLANE - BASIC WEIGHT: 10,561 Lb. @ F.S. 421.6 (Gear Down). This includes the -31 Engine @ 3630 Lb., Pilot's Ejection Seat, Pilot, No Slipper Tanks or Pogos, Residual Fuel & Oil, Engine Oil, Oxygen, Drag Chute, and all Service Bulletins through #372.

APQ-56 AIRPLANE - BASIC WEIGHT: 10,551 Lb. @ F.S. 422.9 (Gear Down). Includes same basic equipment as shown above.

PACKAGES	PACKAGE WEIGHT	ASN-6 AIRPLANES			APQ-56 AIRPLANES	
		ASN-6	WEATHER	FERRY	APQ-56 & PC 210A RADAN	FERRY
Glockenspiel	450			X		X
Destructor	10	X	X		X	
Drift Sight-MK III Control	38	X	X	X	X	X
Sextant	15	X	X	X	X	X
Tracker Camera	58	X	X	X	X	X
System I	17	X	X	X	X	X
System III-Nose Instal.	44				X	X
System III-Cheek Instal.	44	X	X	X		
AN/ASN-6 & PC 204A Radan	235	X	X	X		
PC 210A Radan	166				X	
APQ-56 Equip. Bay Rack	277				X	
APQ-56 Antenna & Misc.	292				X	X
System IV	624	X				
FOG Weather Package	524		X			
TOTAL PACKAGE WEIGHT		1041	941	857	917	914
Zero Fuel Wt. (No Ballast)		11,602	11,502	11,418	11,468	11,465
C.G. - % M.A.C.		20.1	21.3	22.0	24.4	24.3
Basic Ballast On Ring F.S. 673 (S.B. 311)		160	160	160	60	60
Basic Ballast On Ring F.S. 685.5		60	60	60		
Zero Fuel Wt. (With Ballast)		11,822	11,722	11,638	11,528	11,525
C.G. - % M.A.C. (Ballasted)		25.0	26.3	26.9	25.8	25.7

FIG. 5-10

EQUIPMENT	SPECIAL EQUIPMENT VS. AIRCRAFT												
	AIRCRAFT SERIAL NUMBERS REPRESENTED												
	342	343	344	349	351	352	353	355	358	359	360	367	378
Driftsight MK I & J Box	1												
Driftsight MK III	2	1	1	1	1	1	1	1	1	1	1	1	1
Sextant	1	1	1	1	1	1	1	1	1	1	1	1	1
Tracker & J Box	1	1	1	1	1	1	1	1	1	1	1	1	1
A1 Cameras	1	1	1	1	1	1	1	1	1	1	1	1	1
A2 Cameras	1	1	1	1	1	1	1	1	1	1	1	1	1
B Camera	1	1	1	1	1	1	1	1	1	1	1	1	1
System I	1	1	1	1	1	1	1	1	1	1	1	1	1
System III	1	1	1	1	1	1	1	1	1	1	1	1	1
System IV + 100 lb. Chute Ballast	1	1	1	1	1	1	1	1	1	1	1	1	1
System VI	1	1	1	1	1	1	1	1	1	1	1	1	1
F-2 Foil Provisions	1	1	1	1	1	1	1	1	1	1	1	1	1
P-2 Platform Provisions	1	1	1	1	1	1	1	1	1	1	1	1	1
U.S. Mule	1	1	1	1	1	1	1	1	1	1	1	1	1
S.B. 295 Weather Pkg. (100 lb. Chute Ballast)	3	3	3	3	3	3	3	3	3	3	3	3	3
NACA Weather Pkg. Prov. - F295	1	1	1	1	1	1	1	1	1	1	1	1	1
Tape Recorder - Map Case	1	1	1	1	1	1	1	1	1	1	1	1	1
Slipper Tanks	1	3	1	1	1	1	1	1	1	3	1	1	1
Permanent Ballast - 60 lb.	1	1	1	1	1	1	1	1	1	1	1	1	1
Pilot's Ejection Seat	1	1	1	1	1	1	1	1	1	1	1	1	1

FIG. 5-11

Code:

- Provisions provided by kit or installed prior to delivery. Equipment may be installed to existing brackets & wiring. Hatches are provided.
- Provisions could be provided in kit (minor rework - less than three days.)
- Provisions could be provided in kit (major rework - more than 6 days).
- Impractical - space & weight problems.

EQUIPMENT	SPECIAL EQUIPMENT VS. AIRCRAFT					
	PHOTO	SAMPLER	APQ-56	ASN-6		
Driftsight MK I & J Box	1	1	4	4		
Driftsight MK II & J Box	1	1	4	4		
Driftsight MK III	1	1	1	1		
Sextant	1	1	1	1		
Tracker & J Box	1	1	1	1		
A1 Cameras	1	2	2	2		
A2 Cameras	1	2	2	2		
B Camera	1	2	2	2		
System I	1	4	1	1		
System III	1	3	1	1		
System IV	2	2	2	2		
AN/APQ-56 Radar	3	3	1	1		
Radan PC 204 A	4	4	4	4		
Radan PC 210 A	2	2	1	1		
AN/ASN-6	4	4	4	4		
Sampler Nose	4	1	4	4		
F-2 Foil	1	1	1	1		
P-2 Platform	1	1	2	2		
KWM-1 Radio	1	1	3	3		
Weather Pkg. Interim (N.A.C.A.) F295	1	1	1	1		
Weather Pkg. (F.O.G.) F612	3	3	4	4		
ARA-26 Keyer	1	1	4	4		
V.H.F. ARC-12	2	1	2	2		
Ballast Provided-Pounds	60	80	60	220		

FIG. 5-12

AIRCRAFT SERIAL NUMBERS REPRESENTED

- PHOTO: 347, 348, 356, 362, 363, 370, 373, 374, 379, 388, 390, 391, 392, 393
 SAMPLER: 372, 381, 382, 383, 384, 385
 APQ-56: 350, 375, 395
 ASN-6: 376, 386, 387

Code: Same as for FIG. 5-11.

SECTION

TABLE OF CONTENTS

	PAGE
INTRODUCTION.....	6-2
FLIGHT CONTROL CHARACTERISTICS.....	6-2
LONGITUDINAL STABILITY.....	6-2
LONGITUDINAL TRIM CHANGES.....	6-4
DIRECTIONAL STABILITY.....	6-4
ROLLING MANEUVERS.....	6-5
STALLS.....	6-5
LATERAL TRIM CHARACTERISTICS.....	6-5
AIRSPPEED ACCELERATION.....	6-6
HIGH MACH NUMBER CHARACTERISTICS.....	6-6
SPINS.....	6-7
PORPOISING.....	6-8
SPEED BRAKES.....	6-8
GUST CONTROL.....	6-8
TAKE-OFF.....	6-9
CLIMB.....	6-9
CRUISE CLIMB.....	6-9
DESCENT.....	6-9
APPROACH.....	6-10
LANDING.....	6-10
GO AROUND.....	6-11
FLYING WITH EXTERNAL LOADS.....	6-12
FORMATION FLYING.....	6-12



6

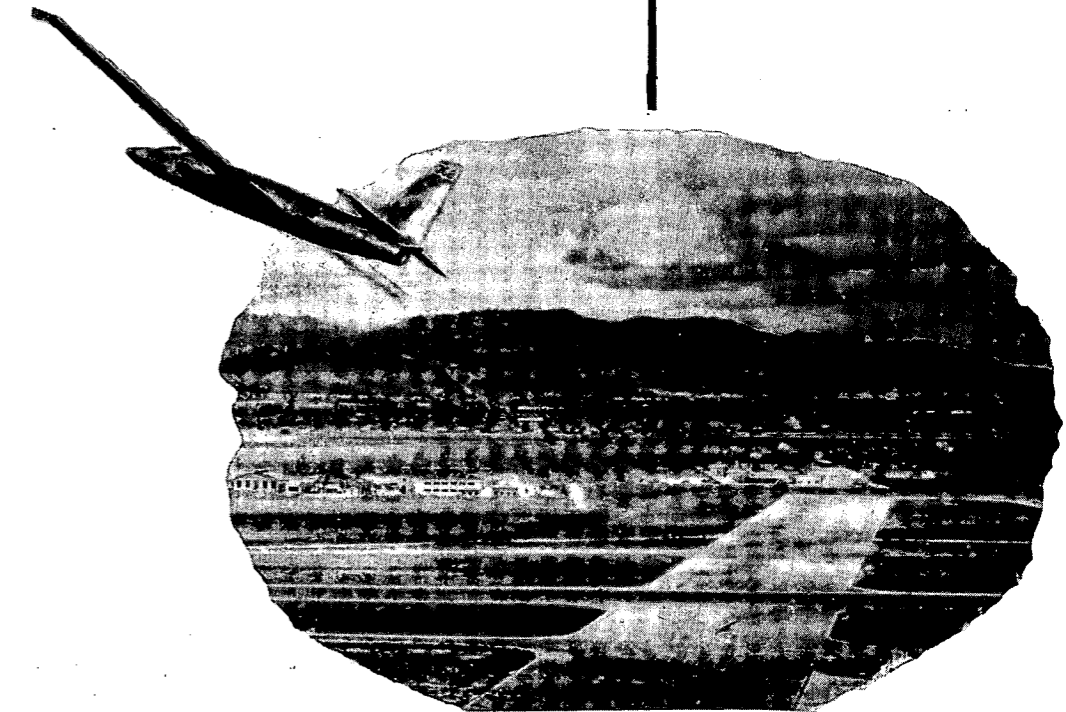

FLIGHT CHARACTERISTICS

INTRODUCTION

The flight characteristics of this airplane are in general conventional and similar to other airplanes. Its design was predicated on maximum performance consistent with reliability. The bicycle landing gear with droppable auxiliary outriggers was devised for minimum weight in order to gain maximum altitude performance. A complete familiarization with the aircraft is essential to full utilization of its capabilities. The information in this section is based on extensive flight testing and operational experience.

FLIGHT CONTROL CHARACTERISTICSGENERAL

The flight controls are conventional, consisting of rudder pedals and a wheel mounted on a control column. All control surfaces are directly connected to the cockpit controls by means of cables. No power boost is provided.

ELEVATOR

The elevator control forces vary from light to heavy depending on C.G. position, airspeed, and other variables. At low speed the forces are light but the elevator is large and relatively effective. Therefore, during the approach and landing stages there should be no abrupt movements of the elevator control, but rather steady light pressures.

AILERON

In general, the aileron control forces will feel heavy, particularly at the higher speeds. This is due in part to the long wing span. At landing pattern speeds the control forces are much lower and the rate of roll is adequate. With the gust control in the GUST position, the aileron forces are lighter but the maximum rate of roll is lower because of the reduced travel of the ailerons. At low altitudes and GUST position, downward rolling maneuvers should be limited due to the reduced aileron travel. However, holding full aileron

for recovery from steep attitudes causes no structural problems.

RUDDER

The rudder control forces are moderately high. The use of the rudder is required for a considerable part of the flying done in this aircraft. During turns it is necessary to use a large amount of rudder for proper coordination. During landing, the rudder is used to maintain runway lineup and counteract cross-wind drift. Since there is very little roll with yaw, only a small amount of aileron is required to compensate for a side slip.

TRIM

Rudder trim is provided by a ground adjustable bend tab. Once this tab has been properly set for a particular airplane, it rarely requires any further attention. However, if directional trim is not correct, the left and right wings will not feed fuel evenly and chronic wing heaviness will result.

Aileron and elevator trim tabs are actuated electrically and controllable from the cockpit. Movement of these tabs is relatively slow.

There should be no substantial lateral trim change with change in speed, as noted by wheel position. When actuating the gust control, the control wheel may rotate but should not hold a considerably different position. Ground adjustments can be made to minimize these effects.

LONGITUDINAL STABILITYSTATIC STABILITY

The airplane is statically stable, but at high altitude is subject to normal Mach number effects which result in "tuck" or increase of nose down pitching moment with speed. Generally, when the airplane is trimmed at a given speed, a push force is required to increase speed and a pull force is required to decrease speed. The force is usually less

than 10 to 15 pounds.

At or near placard speeds, attention should not be diverted from flying the airplane since control force change with speed is small. The speed may increase beyond limits due to inattention or outside upset before the pilot becomes aware of it.

Above 65,000 feet with the gust control in the FAIRED position, the airplane is slightly in tuck at climb speed. If the speed is allowed to increase sufficiently from trim, a pull force is necessary to hold the faster speed or to return to the trim speed. This is due to normal Mach number effects as the airplane approaches its critical Mach number. In the GUST position, the tuck is considerably lessened. A push force is required to fly faster than the standard cruise speed, but the forces are very light.

DYNAMIC STABILITY

If the airplane is flown hands off and the autopilot is not engaged, an attitude upset can cause a long period motion which may be either stable or unstable. Below 60,000 feet the aircraft will generally oscillate slowly from a speed below trim to a speed above trim. Above 60,000 feet, if upset and left hands off, the aircraft will go into a climb or dive and the airspeed will continue to decrease or increase until the pilot corrects the situation.

During approach and landing, the dynamic stability is affected by flap setting, airspeed and power. The airplane will become less stable if full flaps are combined with higher airspeed and higher power. When these effects are combined, such as using full flaps at 120 knots with considerable power, an unstable motion can be developed. This combination is not normally encountered. If it were, an upset would have to be introduced with hands off, before any unusual motion would develop. This motion would take the form of increasing or decreasing speed, together with changing airplane attitude. This is fairly slow in developing after the upset is introduced and is easily corrected by the pilot. With the use of full flaps at

ordinary approach speeds, these effects are not present.

MANEUVERING FLIGHTManeuverability

The acceleration limits are shown in SECTION V. It is possible to reach these limits during maneuvering flight at low and intermediate altitudes. At high altitude the "G" capability is generally limited by buffet and roll off.

At 60,000 feet, buffet starts at about 1.8 "G" and is moderate at 2.0 "G"s.

At 65,000 feet, buffet starts at 1.3 "G", is heavy at 1.5 to 1.7 "G" with roll off at 1.8 "G". A turn can be made just under buffet at 1.2 "G", with a 30° bank angle. The maximum practical turn at this altitude is 1.4 "G" at a bank angle of 40°.

At 70,000 feet, buffet starts at 1.3 "G" and is moderate to heavy at 1.6 "G". If the airplane is light and some excess power is available, altitude can be held in a 40° bank at 1.4 "G", with light buffet.

Maneuvering Stick Forces

The maneuvering stick force normally ranges from 20 to 40 pounds per "G" at aft center of gravity positions. (Aft service loading). However, at slow speed with high power, the force can be lighter than this. At forward center of gravity positions, the force is normally 50 to 70 pounds per "G". At high altitude, the force can be 100 pounds per "G" at speeds near 0.8 Mach number.

HIGH ALTITUDE MINIMUM TRIM SPEEDS

At 24% center of gravity position, the elevator force can be trimmed out at cruise speed. Full nose up trim will probably be required above 65,000 feet. If the force cannot be trimmed out, this is an indication that the center of gravity position is ahead of the forward service loading limit. If this occurs,

the gust control may be shifted to the GUST position and the elevator force can then be trimmed out. Full nose up trim probably will not be required in the GUST position.

EFFECT OF C.G. POSITION

Forward movement of the center of gravity is stabilizing and results in higher stick forces. As may be seen in Figure 5-5, the center of gravity will move forward about 3 1/2% due to fuel usage during a mission. The forces will be lightest immediately after take-off and in the climb. After the fuel is used from the auxiliary tanks the center of gravity position is essentially constant until 50 gallons is remaining.

LONGITUDINAL TRIM CHANGES

LANDING GEAR EXTENTION

The trim change is very slight and may be nose up or down. The force required is 5 pounds or less.

WING FLAP EXTENSION

A nose down trim change occurs, requiring a 15 to 20 pound pull force in about 5 seconds. An opposite effect is produced by flap retraction. If the flaps have been extended and full nose up elevator trim has been applied, do not add full power at the same time the flaps are being retracted until the elevator tab setting has been considerably reduced. High push forces will be encountered under this condition if speed is allowed to increase too rapidly.

SPEED BRAKE EXTENSION

The speed brakes cause a nose up trim change. At approach speeds a 10 pound push force is required in about 5 seconds. Above 175 knots a 25 to 35 pound push force is required in about 6 to 7 seconds.

GUST CONTROL OPERATION

Actuation of the gust control to the GUST position causes an abrupt nose up trim change. A 40 to 50 pound push force is required in 4 to 5 seconds. If desired, the forces may be reduced by applying some countering trim tab before actuation of the gust control.

EFFECT OF POWER

Power application causes a nose up trim change. If the power is increased from idle to maximum RPM, the trim change can be resisted by a push force of 25 to 30 pounds in the first 5 seconds. As the airplane accelerates at constant altitude, the force will build up to 50 or 60 pounds. If trim is used to reduce the force it probably will not have a significant effect until about 10-15 seconds. Power reduction causes a nose down trim change. A 10 to 20 pound pull force is required in 3 to 5 seconds.

If it was decided to increase power from idle to maximum with hands off the controls, the airplane would go into a steep climb which would eventually get very steep if not corrected. Recovery from such a condition may be made by reducing power and pushing out with a slow steady elevator movement, if the climb has not been allowed to go too far. If the power should be applied, hands off, starting from an airspeed slow enough for stall buffet, a mild accelerated stall will be induced as the airplane attempts to round out into a climb attitude.

DIRECTIONAL STABILITY

The maximum steady sideslip angle is about 12° with full rudder deflection. Two thirds rudder will develop about 10° sideslip. The rudder forces are relatively high; at approach and landing speeds about 150 pounds pedal force is required for maximum sideslip. At 250 knots, 150 pounds pedal force is required to develop 2 to 3° steady sideslip.

The aircraft has very little roll due to yaw. Right rudder is required to lift the left wing and vice versa. However, this action is very slow.

ROLLING MANEUVERS

RATE OF ROLL

At approach and landing speeds the rate of roll is about 25° per second with full aileron deflection. The total wheel force is about 40 to 50 pounds. With the gust control shifted to the GUST position the rate of roll is about 10° per second.

The aileron forces become heavier as speed is increased. At 200 knots in the FAIRED position an 85 pound force is required for 15° per second rate of roll; however in the GUST position the force is reduced to 70 pounds.

The rate of roll is considerably higher at high altitude; 45° per second at 67,000 feet for a 50 pound wheel force.

ADVERSE YAW

Rudder should be used to coordinate the roll, particularly during landing approach. A full aileron deflection roll at 85 knots will develop about 15° adverse yaw if it is not coordinated. About 2/3 rudder and 150 pounds pedal force are required to reduce the yaw to zero.

STALLS

ONE G STALLS

The airplane has a moderate stall with normal stall warning buffet. Small sharp edged spoilers located on the wing leading edge near the fuselage cause turbulence at high angles of attack which impinges on the horizontal surface and provides the stall warning. At heavy weights the buffet is less noticeable.

During the approach to the stall, some roll and yaw may be encountered. These characteristics should be controlled by use of aileron and rudder. If the wings are not held level and if there is uncorrected yaw just prior to the stall, the airplane may roll moderately to either the left or right. The pitch down varies from slight at aft C.G. position to abrupt at a forward C.G. position. Recovery is effected by easing the control column forward and controlling roll and yaw with aileron and rudder as necessary. Application of power is effective in stall recoveries at lower altitudes. Stalls should be avoided at very high altitudes due to the probability of a flameout at low airspeeds.

Some airplanes had excessive yaw and roll, both during the stall approach and at the stall. These characteristics were corrected by the installation of special three foot stall strips on the wing leading edges at approximately mid-span.

ACCELERATED STALLS

Accelerated stalls are preceded by buffeting. The stall is normal and may show slight roll off. Recovery is made by relaxing the back pressure.

LATERAL TRIM CHARACTERISTICS

If the basic aerodynamic trim of a particular U-2 aircraft is not properly adjusted, it will result in uneven fuel feeding. If an aircraft has chronic fuel feeding problems, they can usually be traced to this cause.

ELECTRIC AILERON TAB

The controllable aileron tab should be used to adjust for any basic aerodynamic trim characteristics. It can also be used to relieve wheel force due to fuel imbalance during the time required to even the fuel load with the cross transfer pump. However, the fuel cross transfer system must be used to counteract wing heaviness due to fuel imbalance. If the aileron tab is used through-

out the flight to compensate for uneven fuel transfer, a heavy wing will be experienced during the landing.

If a take off is made with full main fuel tanks or with all fuel tanks full, it can be assumed that any lateral imbalance is aerodynamic and should be corrected with the aileron tab. However, later during the flight any further wing heaviness is probably due to uneven fuel feeding. The fuel cross transfer system should be used to correct for this condition.

FUEL CROSS TRANSFER

When take off is made with a partial fuel load it is possible that the amount of fuel in left and right wings is not the same. Therefore, the position of the control wheel must be used as a guide. The aileron tab can be used for trim if the final wheel position is within approximately 5° of neutral. If more trim is required, the fuel cross transfer system should be used.

AIRSPEED ACCELERATION

POWER

The combination of aerodynamic cleanness and high thrust gives this airplane an acceleration potential which makes possible the rapid attainment of speeds in excess of structural limitations. Power can be applied as fast as necessary at lower altitudes. The engine will chug up to about 70% and then accelerate rapidly to full power. Extreme caution should be exercised to prevent exceeding airspeed limitations when

large power increases are made. This condition is more critical on power application with landing flaps extended because of lower structural limitations and the slowness of the elevator trim rate.

DOWNWARD MANEUVERS

Care should be exercised during any downward maneuver due to the rapid acceleration of the aircraft. Do not allow any descent to become so steep that you have difficulty observing the structural limitations during the recovery.

MACH NUMBER CHARACTERISTICS

This is basically a subsonic aircraft and is subject to the same tuck and buzz tendencies associated with most subsonic aircraft. It is placarded to a nominal Mach number of 0.80. With some configurations at high altitude this speed can be extended into the region of .85 mach. At altitudes below 35,000 feet no difficulty will be encountered due to Mach effect if the pilot does not exceed the placard airspeed limitations set up for the aircraft. At all altitudes these Mach characteristics can be aggravated by high gross weight or by extending the speed brakes, or by wing heaviness due to uneven fuel load.

The following chart shows the Mach effect characteristics for both the GUST and FAIRED configurations at different altitudes.

ALTITUDE	GUST CONTROL	I. A. S.	MACH NO.	CHARACTERISTIC
36,000' & 40,000'	Gust	260 235-242	.78 - .80	Excessive Rudder Buzz Slight tuck
50,000'	Gust	194-200	.81 - .83	Excessive Rudder Buzz Slight tuck
50,000'	Faired	200-205	.83 - .85	Moderate tuck Moderate buffet
60,000'	Gust	156-160	.82 - .84	Airframe buffet Mild tuck
60,000'	Faired	158-160	.83 - .84	Airframe buffet Moderate tuck
65,000'	Gust	135-137	.80 - .81	Airframe buffet Mild tuck
65,000'	Gust	137-139	.81 - .82	Moderate tuck Aileron buzz
65,000'	Faired	139-143	.82 - .84	Airframe buffet Moderate tuck & possible roll off
70,000'	Gust	120-122	.80 - .81	Mild tuck
70,000'	Faired	120-124	.80 - .82	Airframe buffet Moderate tuck

In order to stop the aileron or rudder buzzing, it will be necessary to slow down as much as 10 knots below the speed at which the buzz started. Therefore, it is imperative to start recovery as soon as buzzing is felt in the controls. If corrective action is taken as soon as the first Mach effect is noticed, there should be no difficulty making a cautious recovery. There have been times when the aircraft was allowed to go through the first Mach effect because of its weakness, and the Mach effects of another configuration were noticed.

The 0.80 Mach needle generally indicates slightly low and varies somewhat between airplanes. The Mach limit is not a structural limitation and if, during a fast descent, the airplane is flying smooth with the needles together, the speed can be allowed to increase until slight buffet is felt and descent continued at just below this speed. The descent angle may be 10-15°.

The pull out can be made at 1.5 to 1.8 "G" with about 10° up elevator. The elevator forces will vary with c. g. position, configuration, airspeed and load factor. The maximum force should be about 90-100 pounds.

SPINS

Although spins are prohibited, it is possible that the airplane could be allowed to enter a spin. If this should occur, every effort should be made to effect an early recovery since structural damage or failure may easily result from the spin. In the event the airplane enters a spin, the flaps should be retracted. The position of the landing gear is unimportant during the recovery. The following procedure is recommended:

1. Throttle to idle.
2. Rudder against spin rotation.
3. Control column forward until rotation stops.
4. Gust control to GUST, speed brakes extended to decrease the possibility of exceeding structural limits during pull-out.

WARNING

The recovery pullout must be as gentle as possible to prevent exceeding maximum acceleration limits.

PORPOISING

Porpoising is a condition in which the airplane bounces back and forth between main gear and tail gear. A porpoise may sometimes develop on takeoff or landing if proper techniques are not used.

A takeoff porpoise can be caused by trying to raise the tail after the airplane has become airborne without the pilot being aware of it. The main gear will touch and bounce the airplane into the air. Each time the gear touches, the bounce becomes higher. The proper recovery is to ease back the control column and hold the airplane off.

A landing porpoise is caused by touching down too abruptly on the main gear first, which bounces the nose up causing the tail wheel to hit. If you react by pushing the nose down, it will hit a little harder and bounce higher. Each cycle becomes harder and higher. The only recovery method is to add power and go around. The sooner the throttle is pushed forward, the milder the porpoise will be.

SPEED BRAKES

The airplane has conventional speed brakes which are moderately effective. Their primary use is as a drag producing device for descent, approach and landing. The speed brakes can be extended or retracted at any speed. They cause a moderate airframe and tail buffeting which is of no particular concern.

NOTE

At very high altitudes and/or above limit Mach number (0.80), fully extended speed brakes will cause sharp pitching oscillations. There is no loss of controllability, but for a smoother ride, reduce the angle of descent.

The speed brakes are fully variable and can be set at any desired position. In some cases they will creep closed from an intermediate position after a period of time. They cannot creep closed from fully extended position if the switch is left in the extend position.

GUST CONTROL

The gust control is a unique device installed on this airplane to make possible its structural and aerodynamic capabilities.

The wing airfoil section was selected to have the best lift/drag characteristics for cruising flight. This resulted in a very highly cambered airfoil. This in turn causes high nose down pitching moments and resultant high balancing tail loads. As airspeed increases, these tail loads increase very rapidly and a structural weight penalty is imposed on the fuselage and horizontal stabilizer. The portion of the gust control which causes the wing flaps to be shifted up 4 degrees eliminates the high camber of the airfoil and greatly reduces the balancing tail load. The most important fact to remember is that tail loads increase rapidly with airspeed and the placard speed of 220 knots with gust control FAIRED must be carefully observed. With the gust control in the GUST position, the tail loads are materially reduced. However, at the placard speed of 260 knots, limiting wing bending loads are produced if a design gust is encountered. To summarize: tail loads are limiting at 220 knots FAIRED, wing bending turbulence loads are limiting at 260 knots in GUST.

The high aspect ratio of the wing was chosen for good efficiency at high altitude. The resulting long span imposes high structural loads on the wing. In order to accommodate higher gust loads at higher speeds, the center of pressure must be moved inboard. This is accomplished by the portion of the gust control which shifts the ailerons up 10 degrees. This action relieves the wing tip area loads and thereby reduces structural loads on the inboard section of the wing.

CAUTION

The flight instruments should be closely monitored when actuating the gust control at night or in weather, due to the change in trim and attitude gyro presentation.

TAKEOFF

Takeoff acceleration is rapid and the ground roll is short. All other checks should be completed prior to beginning the roll so that the pilot's full attention can be given to the takeoff. At the lighter weights it is not necessary to use full engine power. The tail is raised by pushing forward on the control column in order to preclude any possibility of the airplane becoming airborne too soon. As the tail comes up, there is a very rapid transition since flying speed will be reached quickly. The control column must be moved aft as the airplane breaks ground to keep from contacting the ground again. At forward c. g. positions, the tail will come up more readily than at aft c. g. positions. With neutral elevator tab settings and forward c. g. positions, a moderate pull force is required as the airplane breaks ground and until trimmed. At aft c. g. positions, very little force is required at this point.

If considerable flying has been accomplished in this airplane at light weights, you will become accustomed to a very steep climb attitude immediately after takeoff. On a heavy weight takeoff, do not initially assume as steep an attitude. Be sure to allow the

speed to build up sufficiently before pulling up into the climb.

CLIMB

The early climb will be at a steep attitude. It is not important to hold the climb speed accurately until above an altitude of approximately 50,000 feet. Adjust the lateral trim if necessary according to instructions given in SECTION II.

CRUISE CLIMB

The cruise climb comprises the major portion of a typical flight. The airplane will slowly climb as fuel is burned and weight decreases. Maximum allowable engine power must be used to obtain proper performance. During the cruise climb it is necessary that the normal airspeed climb schedule be closely maintained. Usually, the autopilot will be used to fly the airplane during this phase. If the autopilot is not available, the airplane can be flown in a normal manner except that it will require more attention than it does at low altitudes. If properly trimmed, you can take "hands off" for 30 seconds or more. Since the climb speed schedule is 12 to 14 knots below limiting Mach number, the airplane will have a tendency to "tuck" if you exceed the climb speed. This condition is corrected by exerting a pull force on the elevator control and slowing the airplane back to trim speed. A slow airspeed increases the possibility of an engine flameout, and should be returned to proper speed slowly. No abrupt control movements should be made.

DESCENT

At very high altitudes, idle engine power is very close to maximum engine power. In some cases they become the same; therefore the airplane will not come down easily. As speed is increased and altitude lost, the power drops off slowly. Additional drag is

needed for faster descents. Extension of the landing gear and speed brakes is used for this purpose.

The gust control is left in the FAIRED position until reaching an altitude of approximately 45,000 feet. It should then be actuated to GUST in case turbulence is encountered. At medium and lower altitudes a descent speed of 160 knots is used if turbulence is present or anticipated. If the air is smooth, the rate of descent can be considerably increased by descending at 200 knots IAS.

CAUTION

Wing flaps should never be extended, either partially or fully, for descent since dangerous pitching moments are produced at high altitudes.

During descent, the pilot should be aware of the possibility of encountering high winds at medium altitudes. The descent should be planned so that such winds will not cause you to fall short of your destination. In many cases the descent can be started from a position which will ensure tail winds.

APPROACH

The approach is conventional. Make a lateral trim check before reaching the field as outlined in SECTION II. Initial approach with wing flaps up will require only idle power or slightly more. If full flaps are used after turning downwind, a conventional power approach can be made.

The threshold speeds given for 0 to 15° wing flaps are computed on a basis of 110% of stall speed for zero flaps and 115% of stall speed for 15° flaps. The threshold speeds given for 25° to 35° wing flaps are based on 112% of stall speed for 25° flaps and 114% of stall speed for 35° flaps.

On final approach make liberal use of the rudder to maintain proper alignment and to

correct for drift. If it is necessary to pick up a wing before touchdown, use coordinated rudder to correct for adverse yaw tendency.

LANDING

GENERAL

This aircraft has a conventional landing gear arrangement with the center of gravity located a short distance behind the main gear. The fuselage ground attitude is approximately 4 1/2°. The most desirable method of landing is to contact the ground on both the main and tail gears simultaneously. Skips and bounces are caused by allowing the main gear to touch down first. A pilot with experience in other airplanes having conventional gear usually has less difficulty in the early landing stages than a pilot having primarily tricycle gear experience.

LANDING WEIGHT

At the design landing weight, there is a fuel reserve of 50 to 100 gallons. Most landings in this aircraft are made with additional fuel reserve. This results in a heavier weight than the design landing weight and care must be exercised accordingly.

During the early landing stages of a pilot's checkout, the landing weight should be kept reasonably low. This provides greater structural margin and, even more important, it simplifies lateral and directional control on the runway. When the amount of fuel in the wings is low, there is less sloshing and less lateral inertia. It is recommended that these landings be made with a fuel load of approximately 300 gallons or less.

After the landing stages have been successfully completed, the nominal landing fuel load of 550 gallons is considered satisfactory.

After the pilot gains considerable experience, landings with higher fuel loads can be safely accomplished when the situation requires and when landing conditions are optimum.

WING FLAPS

The use of wing flaps lowers the stall speed and so lowers the touchdown speed. However, of equal or greater importance on this airplane is the added drag with wing flaps extended. With extensions down to 15°, very little drag is added. With 25° flaps, the drag is noticeable. With 35° flaps (full), the added drag is a major factor.

Added drag obtained with full flaps makes a more normal approach possible. Power can be used and varied to change the rate of descent. The touchdown is simpler since the airplane decelerates faster and doesn't have to be held off so long. If a skip or bounce occurs, it is also minimized due to the more rapid deceleration.

DIRECTIONAL CONTROL

The most important thing that can be said about directional control on the runway is to touch down with the aircraft aligned with the runway. During the high speed portion of the landing roll, a steering correction should not be held in too long since it is possible to over-steer.

The position of the control column is very important in assuring adequate directional control. It should be held in the aft position in order to hold the tail wheel firmly in contact with the runway.

GO-AROUND

GENERAL

A go-around is considered to be an unplanned maneuver. Usually something has occurred to upset the landing sequence; a bad approach, an obstructed runway, a landing gear warning horn, or difficulty with completing the landing after touching down.

In this airplane, a large excess of power is available so that there is never a problem in easily reaching a safe altitude and airspeed as far as power is concerned. A go-around

can be made from practically any place on the runway. Fairly substantial changes in control force may be encountered, depending on the amount of power used. The method of application of the power and other pertinent factors are covered in succeeding paragraphs.

BEFORE TOUCHDOWN

If the decision to go-around is made early and power is applied before touchdown, there is no particular difficulty. As power is applied, nose-down elevator trim should be applied to oppose the nose-up trim change induced by power. A moderate amount of push force will also be required. If it is necessary to use full power, the wing flaps should not be retracted until a fair amount of elevator trim has been applied.

AFTER TOUCHDOWN

Wing Flaps

The primary reason for retraction of wing flaps is to remove the necessity for observing the flaps extended placard speed. Therefore, if time permits, the flaps can be started up. If not, they can be retracted later.

Elevator Trim

Application of nose-down elevator trim should be started as the power is applied. The trim is slow and will take time to catch up with the trim changes.

Elevator Forces

As power is applied, the control column should be moved forward slowly and firmly since a push force will be necessary to resist the nose-up trim change and to raise the tail. The magnitude of this force will vary and depends on the amount and rate of power application, c. g. position, airspeed and elevator trim tab position. This force is considered moderate, but requires a change in direction and an increase in

magnitude as compared to that used in the landing approach and landing roll.

Power Application

The power can be rapidly increased to approximately 85% RPM. This results in only a light nose-up trim change. If the power is rapidly increased to the maximum, the trim change is considerably larger and the push forces correspondingly much higher. Usually, 85% RPM is sufficient power for the go-around. If more power is required, it can be added as airspeed increases. If excessive push forces are encountered, they can be relieved by a slight reduction in power.

FLYING WITH EXTERNAL LOADS

SLIPPER TANKS

Slipper tanks do not affect the flight characteristics of this airplane. The additional weight of the 200 gallons of fuel will decrease climb and altitude performance slightly. They cannot be dropped in flight.

POGOS

Droppable auxiliary gears are provided for ground handling and initial roll during take-off. The airplane can be flown satisfactorily at low and medium altitudes with pogos attached. The drag created by the pogos requires slightly more power for level flight and the rate of climb is reduced. There is no change in aircraft maneuverability. They are usually retained on the initial checkout flight to aid the pilot with ground control during landings.

APQ-56

Some aircraft have the APQ-56 antenna attached to the bottom of the fuselage. This has no effect on the flight characteristics.

FORMATION FLYING

This airplane was not designed to participate in formation flying, although it presents no problem if the wing man maintains a position where the lead airplane is easily viewed and clearance is adequate. Extremely close formation should be avoided due to the relatively high aileron control forces and low rates of roll, particularly at the higher speeds. Formation flying should be performed with wing flaps retracted and gust control faired to provide maximum aileron movement.

CAUTION

If extremely close formation is encountered for any reason, be on guard for heavy control forces due to wing downwash.

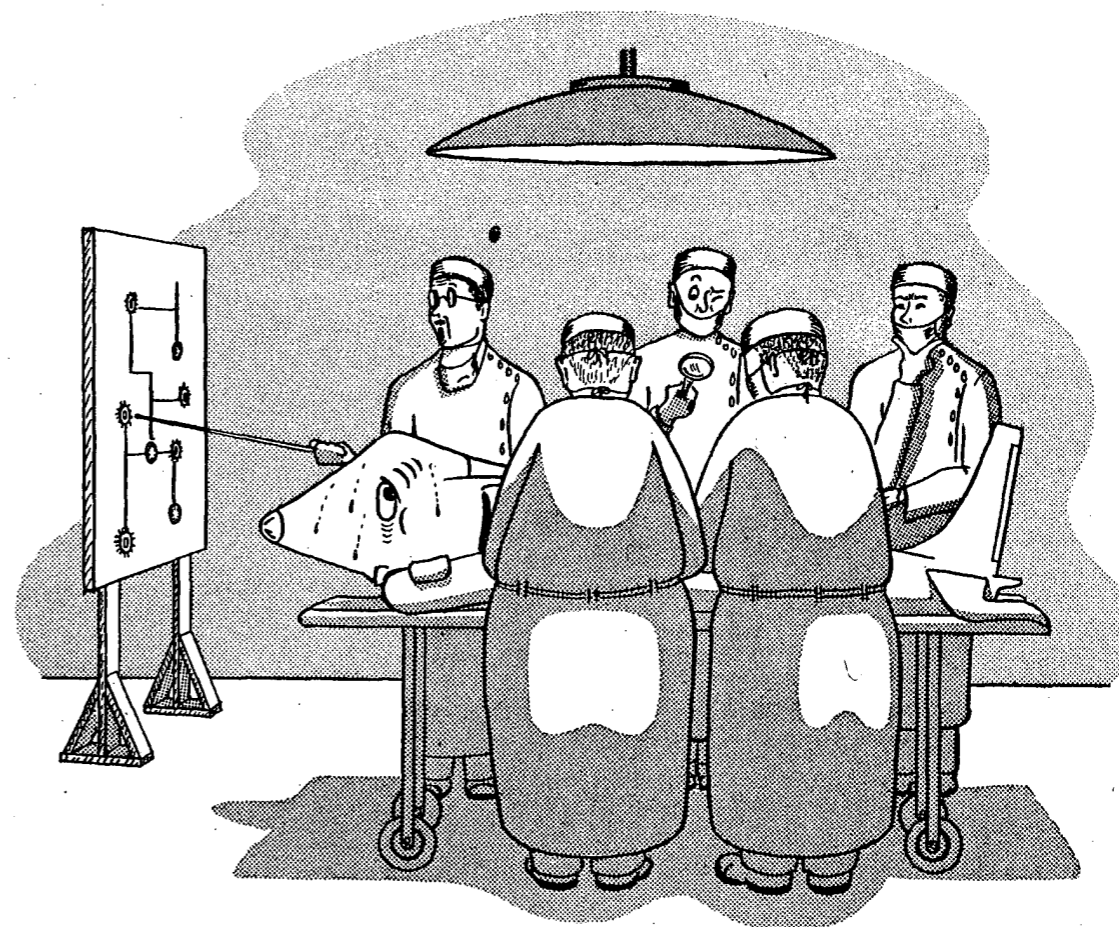

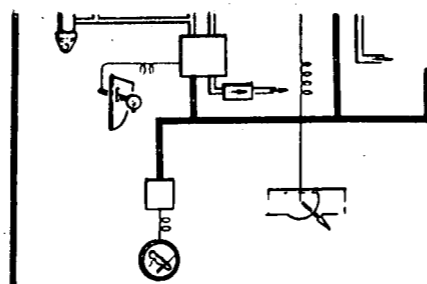

SECTION

TABLE OF CONTENTS

	PAGE
ENGINE OPERATION.....	7-2
FUEL SYSTEM OPERATION	7-3
AUTOMATIC PILOT.....	7-3
BRAKE SYSTEM OPERATION	7-4
AIR CONDITIONING AND PRESSURIZATION SYSTEM	7-5
MA-1 COMPASS OPERATION	7-6
LATERAL-DIRECTIONAL TRIM CHECK	7-6

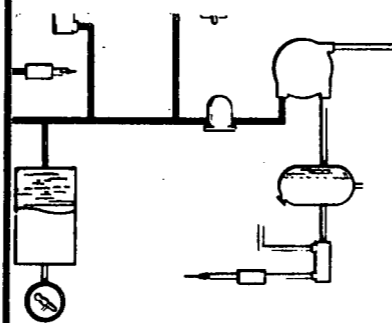
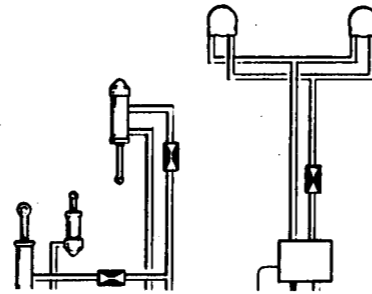

SYSTEMS OPERATION

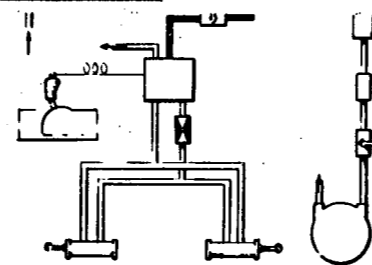

ENGINE OPERATION

COMPRESSOR STALL

The high output, high pressure ratio, J-57 engine was designed to operate at high altitudes with superior fuel consumption. To do this it must operate as close to the stall region as possible. There is no evidence that the J-57 has ever experienced engine damage because of compressor stall. Nevertheless, compressor stall is disconcerting and can result in flameout. Compressor stall is very much like aircraft wing stall, and compressor blades may be thought of as miniature wings. Every airfoil is limited to a maximum angle of attack, which if exceeded, will cause the airfoil to stall. As with the wing stall experienced in the aircraft, the air separates from the airfoil section. With this separation, the lift is greatly reduced on the wing. In the compressor, this loss is evidenced as a loss in pressure ratio and therefore a reduction in pressure level at the compressor discharge.

During acceleration, compressor stall may be encountered due to improper fuel scheduling to the burner. For instance, if the fuel flow is too high, temperature and pressure in the burner become higher than design limits, thereby causing abnormal back pressure on the compressor. This decreases the airflow for a given RPM. The effective angle of attack increases beyond the airfoil's critical angle of attack and causes the airfoil section to stall. This results in reduced airflow for an instant in the compressor and pressures are greatly reduced.

Another condition of possible compressor stall occurs at high altitude, particularly with high power operation. This condition is brought about by low temperature and Reynolds Number effect. When the air gets thinner, it has difficulty in following the contours of the airfoil section of the compressor blade, thereby reducing the stall margin. As the air gets colder, the engine tends to operate closer to stall. Therefore, more care must be exercised when operating at altitude where the air is both thin and cold.

Stalls vary in severity, depending on whether

the stall involves only a portion of a stage, a stage, several stages, or an entire compressor. Partial stall may produce roughness with or without audible accompaniment of rumble, drone, etc. More complete stalls may produce noises varying in intensity from pistol shots to cannon fire, and can be very disconcerting if the pilot doesn't know what to expect.

To avoid compressor stalls at high altitude with the J-57, the pilot must remember the following:

1. Make no abrupt throttle movements.
2. Climb at recommended airspeed and control the engine power to stay within PR limits.
3. Avoid abrupt or uncoordinated maneuvers.

To get the engine out of a compressor stall, the pilot should slowly retard the throttle until the compressor stall stops or the throttle reaches idle. If the stall persists in the idle position, reduce altitude and increase airspeed to maintain an even pressure distribution at the compressor face. The chances of stall recovery improve as altitude decreases because of higher compressor inlet temperatures and the Reynolds number effect. Since there is a possibility of overtemping the engine during a compressor stall, the pilot should be prepared to shut off the engine if corrective action does not break the stall. Compressor stall at high altitude will result in flameout. A descent must be made to air start altitude.

POWER REGULATION AT ALTITUDE

The primary engine operating variables are engine speed, pressure ratio and exhaust gas temperature. These limits must be carefully observed at altitudes above 50,000 feet in order to avoid engine compressor stall. (See SECTION V for specific limitations.) An altitude will sometimes be reached where the minimum fuel flow setting equals that required for maximum exhaust gas temperature. This is called "minflow".

In this case, retarding the throttle to idle will not change the power condition. In the event the maximum EGT is exceeded, it can be reduced by increasing speed or lowering the gear and/or extending speed brakes to lose altitude. Minimum fuel flow for the P-31 engine is lower than for the P-37 engine. Therefore, minimum pressure ratio is normally encountered before minimum fuel flow, with the P-31 engine. The recommended pressure ratio schedule is then followed. Pressure ratio response is very sluggish and all throttle movement must be made slowly.

COMPRESSOR BLEED VALVE

If the engine bleed valve fails to close upon initial power application and remains open during flight, a flameout may occur above 63,000 feet with the P-37 engine. This altitude will vary according to atmospheric conditions. A normal restart can be made and the flight continued below the altitude where the flameout occurred. Flight above 63,000 feet should not be attempted under these conditions. If the bleed valve remains open with the P-31 engine, available power is reduced and maximum altitude will not be attained. If the bleed valve opens above 68,000 feet with the P-31 engine, there is a possibility of flameout.

ENGINE "CHUGGING"

Chugging is a characteristic of both the P-31 and P-37 engines during acceleration from low RPM's through approximately 70% with moderate to fast throttle movement. The chugging is not harmful to the engine but may be prevented by slow throttle movement. The flexibility of the fuselage on this aircraft may cause chugging at low RPM's in turbulence or with abrupt movement of the control column.

FUEL SYSTEM OPERATION

The fuel system ordinarily requires little of the pilot's attention because of its simplicity. The only direct control located in the cock-

pit is the fuel cross transfer switch. This controls a small reversible pump and is used to level the fuel load in the left and right main wing tanks. This may be necessary due to an uneven partial load at take off, or due to uneven fuel transfer in flight. If an aircraft has chronic wing heaviness due to uneven fuel transfer, it is usually due to a basic trim problem, and should be corrected.

The fuel transfer system is very simple and reliable. The only time there may be a slow down in transfer rate is during descent. This is due to a lowering of the air pressure inside the tanks caused by the change in altitude. This sometimes causes the fuel low level warning light to come on. This should not occur on airplanes having the new double vent line installation.

The sump overflow light should not come on with airplanes having the double vent line. If it does the only action the pilot can take is to return and report the system for maintenance correction.

AUTOMATIC PILOT

FLIGHT CHECK OF THE AUTOMATIC PILOT

1. Flight Conditions
 - a. Any airspeed within structural limitations.
 - b. MA-1 compass synchronized.
 - c. Aircraft manually trimmed for straight and level flight.
 - d. Automatic pilot on and engaged.
 - e. Mach Sensor off.
 - f. Smooth air.
 - g. Automatic pilot trimmed for straight and level flight.

2. Overpower Response

The overpower response test can be quickly and easily applied at any time during flight and furnishes a good indication of the autopilot control performance. It is recommended that a brief overpower

response be made following initial engagement of the autopilot on any flight, and also at any other time during flight there is reason to question the operation of the autopilot. The test consists of overpowering the autopilot by applying force on the controls, thereby changing the airplane attitude; then releasing the control and observing the action of the autopilot in returning the airplane to its original attitude. Roll, yaw and pitch controls are tested separately, (one at a time), and in both directions.

3. Pitch Operation

Check action of the pitch wheel. The pitch axis should be overpowered to approximately a 5 degree attitude change. At higher indicated airspeeds it may be necessary to limit this deviation to 3 degrees because of structural limitations. Release the overpower and observe the response of the airplane as it returns to the autopilot controlled attitude. The response should be essentially smooth and exhibit no scalloping, hesitations, oscillations, undershooting or overshooting.

Check that the vertical speed indicator is stabilized at zero. Turn the Mach sensor on and note that the engage error does not exceed two inches control column movement. Pitch oscillations, if any, after engagement should remain within following limits:

- a. Amplitude of oscillation \pm 100 feet
- b. Period of oscillation not less than 60 seconds per cycle
- c. Airspeed change should not exceed \pm 1 knot.

NOTE

Lowering gear, extending speed brakes or turning with the Mach sensor on may momentarily cause some oscillation.

4. Roll Operation

For the roll axis the overpower should be from 15° to 30° of bank. Release the overpower and observe the response of the airplane as it returns to the controlled attitude. The response should be essentially smooth and exhibit no scalloping, hesitations, oscillations undershooting or overshooting. Check for aileron wallow.

5. Yaw Operation

For yaw axis the overpower should be applied to approximately a 5 degree displacement. At higher indicated airspeeds it may be necessary to limit this deviation to 2 degrees because of structural limitations. Release the overpower and observe the response of the airplane as it returns to the controlled attitude. The response should be essentially smooth and exhibit no scalloping, hesitations, oscillations, undershooting or overshooting.

NOTE

Do not perform this check at high altitude since a possibility of flame out exists.

6. Turn Knob Operation

Rotate turn knob to full displacement each direction. The bank angle should be 25 degrees \pm 5 degrees in both directions. (Left and right maximum bank angles can differ as much as 5°.) When returning the turn knob to detent position, hold the knob out of detent until the wings are straight and level. Turn response should be smooth with no oscillation or erratic movements.

BRAKE SYSTEM OPERATION

NORMAL BRAKING

Normal braking is obtained by depressing either or both pedals since both brakes

operate from a single master cylinder. Ordinarily the brakes are not applied until the airplane has decelerated to 40 to 50 knots. Then when it is decided to stop, at about 30 knots, they are applied moderately hard. Heavy braking above 60 knots should be avoided to prevent tire and brake damage. Use extreme care when operating the brakes anytime a wing is low since excessive braking will lock the wheel with the least amount of friction, thus causing a flat spot or blown-out tire. Brakes must not be used to hold engine power above 85% RPM or landing gear failure may result.

TIRE SKIDDING

Brakes themselves, can merely stop the wheel from turning, but stopping the airplane is dependent on the friction of the tires on the runway. For this purpose it is easiest to think in terms of coefficient of friction, which is equal to the frictional force divided by the load of the wheel. It has been found that optimum braking occurs with approximately a 15% to 20% rolling skid; the wheel continues to rotate but has approximately 15 to 20% slippage on the surface so that the rotational speed is 80% of the speed which the wheel would have, were it in free roll. As the amount of skid increases beyond this amount, the coefficient of friction decreases rapidly so that with a 75% skid the friction is approximately 60% of the optimum and, with a full skid, becomes even lower. There are two reasons for this loss in braking effectiveness with skidding. First, the immediate action is to scuff the rubber, tearing off little pieces which act almost like rollers under the tire. Second, the heat generated starts to melt the rubber and the molten rubber acts as a lubricant. NACA figures have shown that for an incipient skid with an approximate load of 10,000 pounds per wheel, the coefficient of friction on dry concrete is as high as .8, whereas the coefficient is of the order of .5 or less with a 75% skid. Since the coefficient of friction goes down when the wheel begins to skid, it is apparent that a wheel, once locked, will never free itself until brake pressure is reduced so that the braking effect on the wheel is less than the turning moment re-

maintaining with the reduced frictional force.

AIR CONDITIONING AND PRESSURIZATION SYSTEM

FLIGHT CHECK OF CABIN AND EQUIPMENT BAY PRESSURIZATION SYSTEM

The functioning of the cabin and equipment bay pressurization system may be checked during flight. The schedule of cabin pressure may be obtained from the chart in SECTION IV under "Air Conditioning and Pressurization System". This check should be performed at 15,000 feet indicated airplane altitude:

1. Cabin and equipment bay seal valves on.
2. Ram air switch on. Note cabin and equipment bay altimeter equalize to 15,000 feet.
3. Turn ram air switch off. Note restoration of cabin and equipment bay altimeter to 7500 ft. Select cabin and then equipment bay on the altimeter.

NORMAL PRESSURE SCHEDULE CHECK

Climb to maximum altitude and note cabin and equipment bay follow normal schedule. At 70,000 feet individually select cabin and equipment bay pressurization. Note that both are between 28,000 and 30,300 feet.

FLIGHT CHECK OF AIR CONDITIONING SYSTEM

This check may be performed at any altitude, although at lower altitude cockpit fog may form in the colder positions.

1. Cabin and equipment bay seal valves on.
2. Ram air switch off
3. Check air conditioning in both automatic and manual positions to both limits. The control valve takes approximately 14 seconds from one limit to the other in both positions of control.

The temperature change will take much longer due to the temperature lag of the air ducts. The cabin altitude will probably change when the temperature setting is changed. Fluctuations in one position and lack of fluctuations in the other may indicate some fault with the air conditioning system. Note the cabin and equipment bay pressures. The altitude should hold relatively steady when the air flow is stabilized.

MA-1 COMPASS OPERATION

In order to properly understand the operation of the MA-1 compass, it must be realized that the compass indicator shows the position of the compass gyro. A Slaved-Free switch is provided to select the source of compass indicator information. In the FREE position the compass indication is of an unslaved directional gyro and movement of the gyro for other than normal precession must be accomplished by the Set Heading switch. In the SLAVED position the gyro is slaved to a magnetic flux valve located in the left wing tip. Maximum slaving speed is about 2° per minute so that it is readily apparent that if the compass indication should be 180° off, when slaving is begun it would take about 1 1/2 hours to obtain the correct reading without use of the set heading switch. A sync indicator is provided to show when the gyro is synchronized with the magnetic flux valve. The sync indicator is inoperative when the slaved-free switch is in FREE position. The sync indicator is extremely sensitive so that when very near the correct indication short flicks of the Set Heading switch are necessary to obtain a near centered indication. It is not necessary to exactly center the needle because the normal 2° per minute slaving will take care of the small error in a short time. It is necessary to consider one aspect of operation of the MA-1 compass during autopilot operation. When the Set Heading switch is used the autopilot is automatically turned off and a time delay of about 3 minutes is imposed before it may be turned on. This time delay allows the auto-pilot heading gyro to slave to the new MA-1 compass heading.

LATERAL - DIRECTIONAL TRIM CHECK

A flight check of the lateral-directional trim of the airplane should be accomplished as follows:

1. The fuel load MUST be even in order to make a successful trim check.
2. The check should be accomplished immediately after take off. Climb to approximately 10,000 ft. Do not use the electric aileron trim.
3. Assume straight and level flight, gust control FAIRED, power as required for 150 KTS. IAS.
 - a. Note position of ball and needle on turn and slip indicator. Feet off rudder pedals.
 - b. Note aileron wheel position and force necessary to hold wings level.
 - c. Actuate the gust control to GUST and note action of the control wheel.
4. Accelerate to 250 kts IAS, straight and level flight.
 - a. Note turn and slip indication, feet off pedals.
 - b. Note aileron wheel position and force necessary to hold wing level.
5. Report results of check for possible adjustment of airplane trim.

SECTION

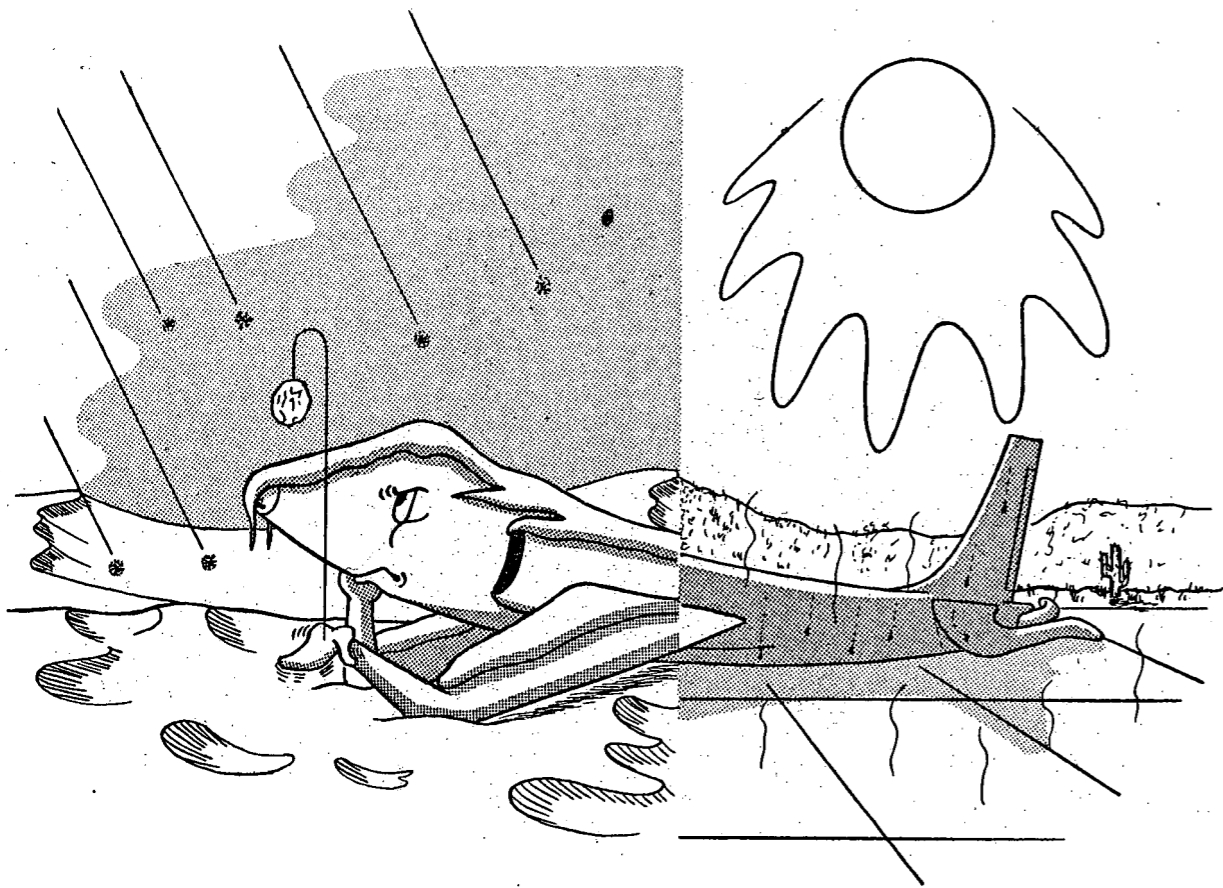
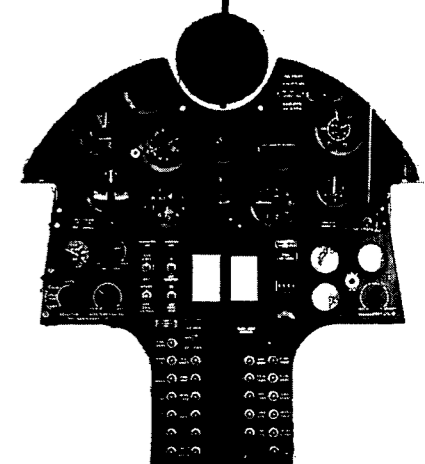

TABLE OF CONTENTS

	PAGE
INTRODUCTION	9-2
INSTRUMENT FLIGHT PROCEDURES.....	9-2
ICE AND RAIN.....	9-5
TURBULENCE AND THUNDERSTORMS	9-7
NIGHT FLYING.....	9-8
COLD WEATHER OPERATION	9-8
HOT WEATHER AND DESERT PROCEDURES.	9-8



ALL WEATHER OPERATION

INTRODUCTION

Except where some repetition was necessary for emphasis, clarity, or continuity of thought, this section contains only those procedures that differ from or are in addition to the normal operating instructions.

INSTRUMENT FLIGHT PROCEDURES

GENERAL

Pilots flying the U-2 must maintain a high degree of instrument proficiency. A standard operating procedure is employed by the pilot during all phases of instrument flight. Performance data, techniques, and procedures recommended are based on a standard U-2 aircraft. It is especially important that recommended airspeeds be adhered to on the final part of an instrument landing approach. An approach at speeds exceeding those recommended may result in overshooting, because the low drag characteristics make it difficult to quickly reduce airspeed unless full wing flaps are used. Turns will not exceed 30 degrees of bank. Turns during standard instrument approaches are 2 needle width and made at the rate of 3 degrees of turn per second.

NOTE

For high altitude operation, a 30° bank will be a 1 needle width turn and made at a rate of approximately 1 1/2 degrees of turn per second.

PREFLIGHT

To insure a successful flight under instrument conditions, complete the normal preflight inspection as given in SECTION II. Particular attention must be placed on the proper functioning and settings of flight instruments, radios, and any electronic navigational equipment aboard.

TAXI

No taxi checks other than those listed in SECTION II are required.

BEFORE TAKEOFF

Accomplish the before takeoff check as listed in SECTION II. After aligning the aircraft visually on the runway, adjust the miniature aircraft of the attitude indicator level with the 90 degree indicies marks on the indicator case. Check MA-1 compass heading against known runway heading. Turn on the pitot heat if a weather penetration is expected.

INSTRUMENT TAKEOFF AND INITIAL CLIMB

1. The takeoff roll is the same as a normal VFR takeoff. The aircraft alignment is maintained by visual reference to runway during takeoff roll.
2. Retract the landing gear as soon as aircraft is definitely airborne and a positive climb is established by reference to the vertical speed indicator and altitude - a positive rate of climb should be maintained during gear retraction.

INSTRUMENT CLIMB

1. Below 40,000 feet, maintain no more than 90 percent RPM which will result in a reduced climb attitude and provides a better attitude indicator presentation. The attitude indicator presentation with full power and 160 knots IAS is difficult to accurately interpret.
2. Maintain 160 knots for climb until climb schedule requires a reduction of indicated airspeed.
3. Shift gust control to GUST position prior to entering cloud formations, or as soon after as possible when a low ceiling exists, but not lower than

1000 feet above the terrain. Return to FAIRED position at 40,000 feet or when clear of clouds.

4. Climbing turns should not exceed 30 degree bank on the attitude indicator.

LEVEL OFF

A definite level-off is not made when climbing to maximum altitude. When leveling at a specific altitude, power reductions must be made to preclude exceeding airspeed limitations.

INSTRUMENT CRUISE FLIGHT

Rarely will a maximum altitude flight in the U-2 be conducted under other than visual flight conditions. Experience has shown that only an occasional cumulus cloud in tropical regions will reach the U-2 cruising altitudes. Cruising flight under instrument conditions below maximum altitude is the same as cruise flight under visual conditions, except aircraft should be flown in GUST configuration.

STEEP TURNS

Bank angles of more than 30 degrees in the U-2 are not considered a normal maneuver in instrument conditions and should only be employed in an emergency.

HEADINGS

Heading control during instrument flying is the same as for visual flight.

HOLDING

To enter a holding pattern, reduce power to required setting and slow aircraft to holding airspeed of 120 knots.

DESCENT

Descent under instrument conditions is performed as outlined in SECTION II, Normal Procedures, except that pitot heat will be turned on.

TYPICAL JET PENETRATION PROCEDURES

For a typical Jet Penetration procedure, see Figure 9-1. Prior to beginning penetration, obtain current altimeter setting and note fuel quantity for computation of pattern and threshold speeds. This removes the necessity of recomputing during approach under instrument conditions.

Initial Penetration Altitude

Over the fix for an instrument penetration, the gear is down and the gust control is in GUST position. The throttle is retarded to idle, speed brakes extended and airspeed held at 160 knots as in a normal penetration.

NOTE

During entry into the descent and until reaching 160 knots IAS, the attitude indicator is the primary pitch control instrument.

Penetration Turn

Normally the penetration turn is started at approximately one half the difference between the initial penetration altitude and the minimum penetration altitude, or as published in the appropriate Jet Pilot Instrument Handbook. A bank of 20 degrees is recommended in the penetration turn; however, a bank of 30° should not be exceeded.

Minimum Penetration Altitude

Minimum penetration altitude is as published in the appropriate Pilots Handbook. Complete the Before Landing Check and decelerate to threshold plus 10 knots before starting low

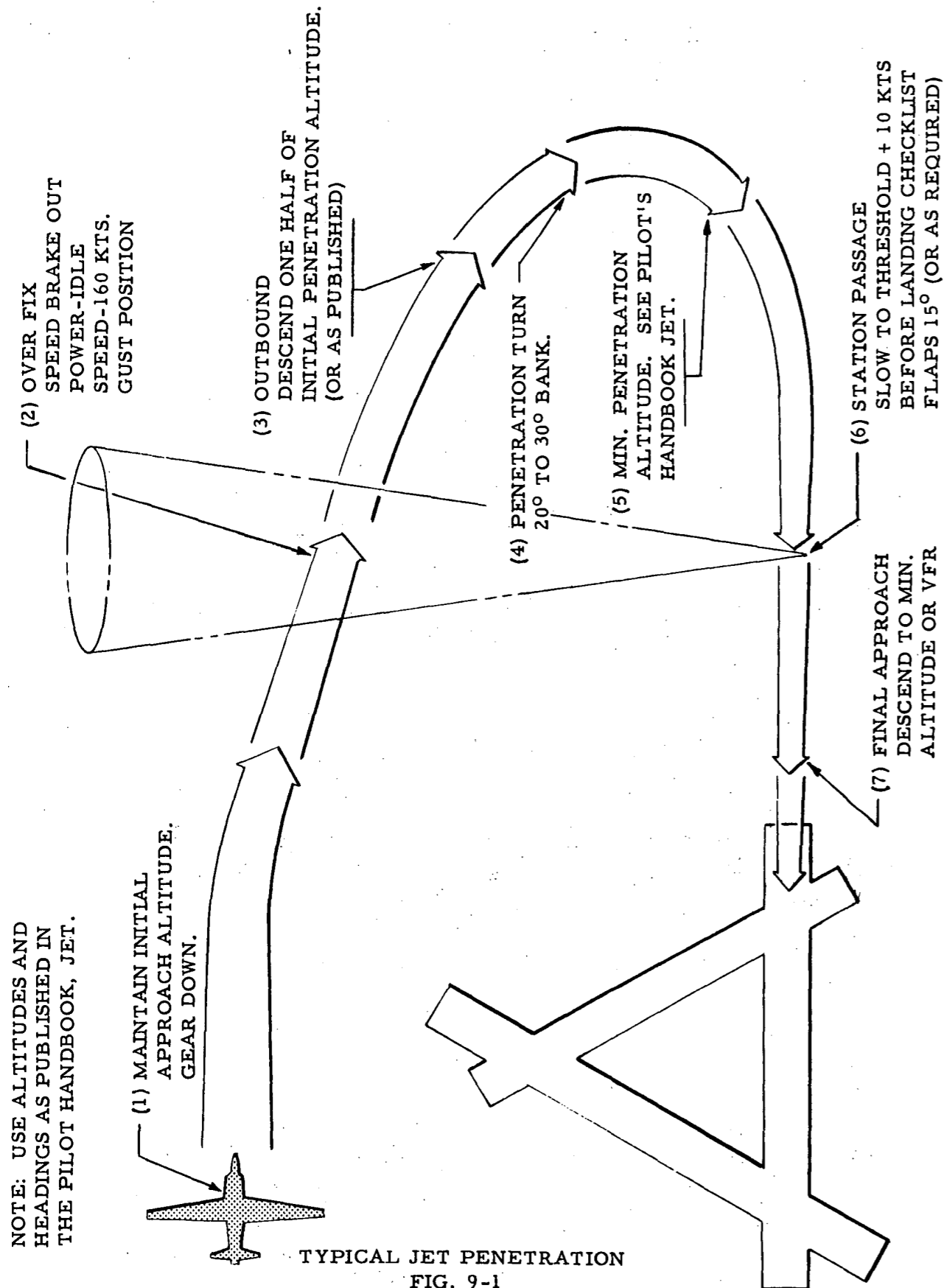

approach or reaching GCA final, whichever is applicable.

Low Approach

After passing the radio fix at minimum penetration altitude, begin descent to minimum approach altitude or VFR conditions (whichever is higher) at a rate not to exceed 1000 FPM.

MISSED APPROACH PROCEDURE

When necessary to execute a missed approach from an instrument letdown, or GCA, proceed as follows:

1. Add power as required (80-90% RPM)
2. Raise flaps before reaching 130 knots.
3. Execute published missed approach procedure, or proceed as directed by controlling agency.

GROUND CONTROLLED APPROACH (GCA)

For a typical GCA procedure, see Figure 9-2. The steps in this example will be accomplished by the pilot on instructions from the GCA traffic director and final controller. Two types of traffic patterns are most commonly specified by GCA traffic director. One is conventional rectangular pattern and the other is a straight-in approach from a distance of 10 miles or more. Regardless of the pattern flown, the complete approach procedure is divided into four phases:

1. Initial approach

The initial approach is the pattern, including identification turns, holding, and vectoring up to the final approach. The GCA traffic director will give instructions during this phase of the approach.

2. Final approach

The final controller takes over radio contact, usually on a different frequency, at a range of about 7 miles from the end of the runway and continues giving instructions until over touchdown point. The final controller will talk continuously, giving instructions and information on the position of the airplane in relation to the course and glide path. The steady flow of conversation aids in making smaller corrections during the final approach, and gives immediate warning of any failure of radio communication. If no transmission is received during any 5 second period of the final approach, initiate a missed approach.

3. Prelanding

The prelanding portion of the pattern is flown after breaking out of the overcast until just before contact is made with the runway. There should be no hesitancy to execute a missed approach if visual contact is not made by the time GCA minimum altitude is reached. The prelanding phase is a transition period from instrument flying to visual flying. During change-over, continue to follow instructions from the final controller until it is evident that visual contact with the ground will not be lost.

4. Touchdown and landing roll

The final controller notifies the pilot when the airplane is over touchdown point. Touchdown and landing is made by visual reference to the runway, using the normal flare and touchdown procedures as described in SECTION II.

ICE AND RAIN

The airspeed pitot tube is provided with a heater element which is controlled by the pilot. Protection of the aircraft from ice on

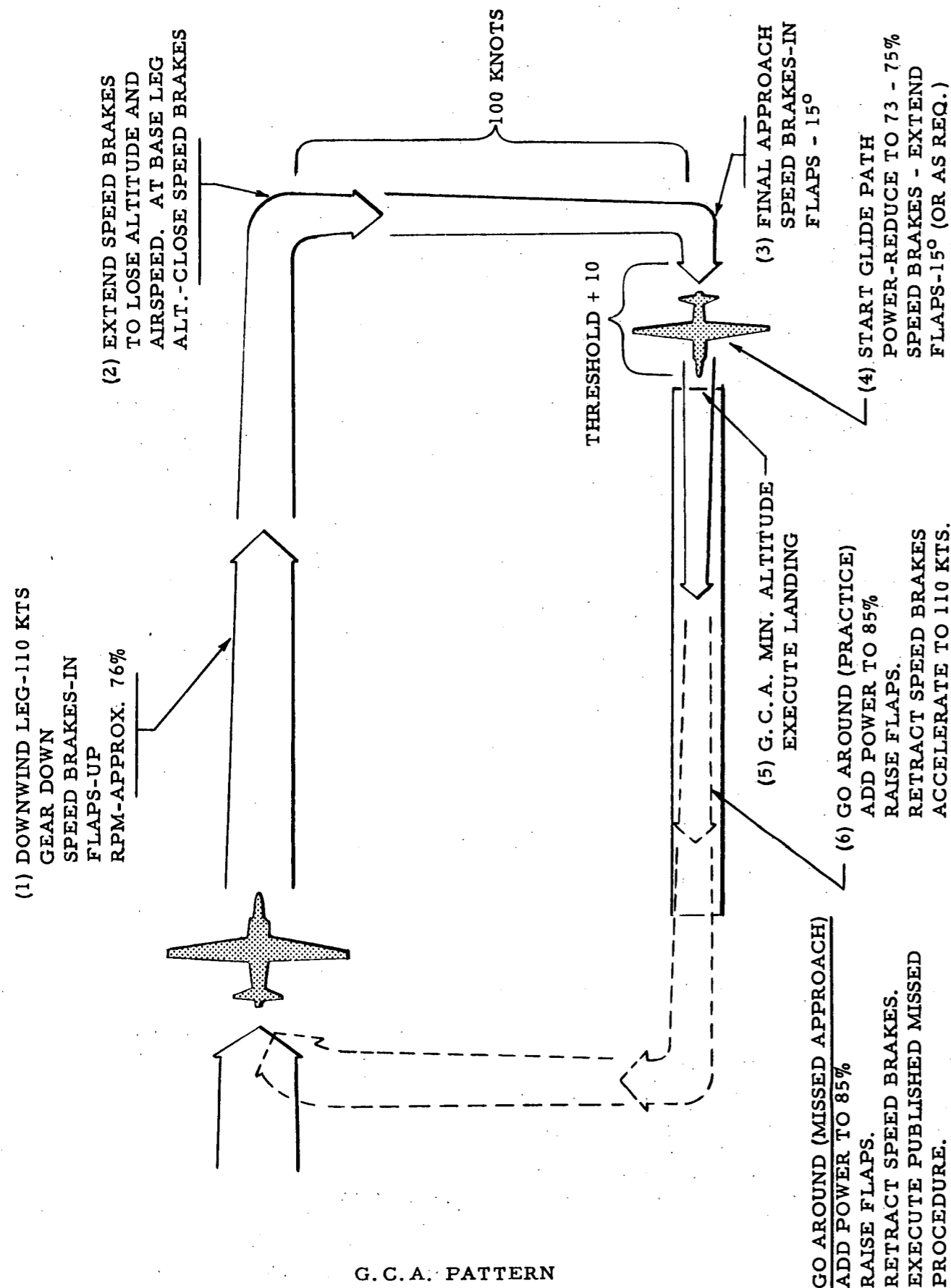
G. C. A. PATTERN
FIG. 9-2

the ground is covered under "Cold Weather Procedures", this section.

NOTE

Ordinary rain gives no appreciable trouble in flight other than to restrict visibility. It is possible for heavy rain to cause incorrect airspeed readings.

In moderate to heavy turbulence at normal cruising altitudes above 60,000 feet, leave the gust control FAIRED since the stall will be reached before limit load factor.

ICING

See Tech Data Change FM-8

Icing occurs because of the presence of supercooled water in visible moisture such as fog, clouds, or rain. The most severe type of ice formation will occur at temperatures of approximately -5 degrees C (23 degrees F). Icing conditions usually will not be encountered at altitudes above 25,000 feet, except in cumuliform clouds such as thunderstorms.

Thunderstorms should be avoided in the U-2 because of its low structural load limitations. Normal cruise flight will generally be above all thunderstorms. Flights should not be planned through an area where thunderstorm penetration might be possible. Thunderstorm penetration in the U-2 should be made only in case of an emergency.

The greatest concern when operating in icing conditions in the U-2 is structural icing in climb or descent phases of a mission. Before any visible moisture is encountered in either climb or descent, the defroster should be set and the pitot heat turned on.

If it is impossible to avoid entry into a thunderstorm, the aircraft should be prepared prior to penetration. Power setting and pitch attitude to provide a good attitude gyro presentation should be established prior to entry. Gust control should be placed in the GUST position.

An icing condition can be quickly avoided by increasing the rate of climb and bringing the aircraft out of the icing levels. In the descent, if an icing condition is encountered or if an icing condition is suspected, the pilot should initiate a fast descent in an effort to pass through the icing level as quickly as possible. If the icing becomes severe after level off at low altitude, the pilot should start a climb above the icing condition and proceed to an alternate.

NOTE

It is possible to place the gust control in the GUST position even when the aircraft is flamed-out if hydraulic pressure and electrical power are available.

Engine icing is not a problem in this aircraft.

TURBULENCE AND THUNDERSTORMS

It is possible, in this aircraft, to encounter light to heavy clear air turbulence at normal cruising altitudes. Light turbulence will not prevent use of the autopilot. Moderate to heavy turbulence may cause the autopilot to overcontrol and will necessitate the pilot having to switch off the autopilot and manually fly the aircraft.

The recommended airspeed for thunderstorm penetration is 120-130 knots IAS. The pitot heater switch should be turned ON. Tighten safety belt and shoulder harness. Turn off any radio equipment rendered useless by static and turn cockpit lighting full bright to minimize blinding effect of lightning.

While in the storm, maintain a constant power setting and fly pitch attitude. Expect turbulence, precipitation and lightning. Concentrate primarily on maintaining a level attitude by reference to the attitude indicator. Do not chase the airspeed indications or extreme aircraft attitudes may result. A heavy rain may interfere with the indicated airspeed by partial blocking of the pitot tube

pressure head. Use as little elevator and aileron control as possible in order to minimize the stresses imposed on the aircraft.

CAUTION

Although a constant power and pitch attitude is flown, the airspeed should be monitored so as not to exceed placard speed.

NIGHT FLYING

Check the lighting equipment thoroughly and be familiar with the location of all lighting switches in the cockpit. For night taxiing, the landing lights will be used to enable the pilot to observe and avoid obstacles. No navigational lights are provided on the U-2. There are anti-collision beacons; one above and the other below the fuselage. On night weather flights these lights can induce vertigo. The pilot should not hesitate to turn them off if symptoms of vertigo arise. The use of oxygen on all night flights is recommended. The pilot will carry a flashlight for all night flights.

COLD WEATHER OPERATION

Cold weather operation of the U-2 does not present abnormal difficulties; however, certain precautionary procedures should be employed to provide safe operational conditions and afford pilot comfort.

The majority of cold weather operating difficulties are on the ground. Fresh or melted snow must be removed to insure necessary traction. To prevent possible structural damage to the aircraft during ground operation, all snow or ice covered areas must be level and free of ruts. Non-skid material, such as sand, should be available for application on the runway when adverse crosswinds exist.

The U-2 should be hangered during cold

weather operations to minimize fuel, oil, hydraulic and air leaks.

Caution must be exercised when refueling aircraft with very cold fuel since expansion may result in fuel system component failures. By not fully servicing the sump tank, adequate space will be available for fuel expansion. The sump tank can be topped off prior to flight to insure maximum fuel service.

All aircraft ground checks are as listed in SECTION II. The aircraft is prepared for flight and readied for engine start through pilot's cockpit check prior to towing from hangar to the starting area. Station time must be adequate for performance of all required checks, yet reduced to a minimum for crew protection.

The performance of the U-2 in cold weather is generally similar to the normal performance of the aircraft. Takeoff roll is shorter and initial rate of climb greater. In northern latitudes the lower tropopause results in the aircraft reaching minimum flow at a lower indicated altitude.

HOT WEATHER AND DESERT PROCEDURES

Hot weather and desert operation is virtually identical with normal operation with these exceptions:

PILOT COMFORT

Pilot comfort prior to takeoff and at low altitudes is a necessary consideration. It is recommended that an air conditioned vehicle be employed to transport a pilot from the point of pre-breathing to the aircraft. The pilot should exert himself as little as possible, when exposed to the heat, to prevent overheating. After the pilot is in the aircraft, it is recommended that air conditioning be piped into the cockpit, and/or a protective sun shade be installed to shield the pilot from the sun.

EXTERIOR INSPECTION

Intake ducts should be inspected for evidence of sand. If excessive sand is found, do not start the engine until a more thorough check has been made and sand is removed. Shock strut pistons should be examined for dust, and dust removed with a soft dry cloth.

ON ENTERING THE AIRPLANE

Excessive dust accumulation on instrument dials and blown sand on movable flight controls, dials, and switches must be cleaned away. Care must be exercised in any contact with the canopy as plexiglas is damaged easily in hot weather.

JUST PRIOR TO STARTING ENGINE

The external sun shield over the cockpit should be removed.

The ground air conditioning should be the last thing removed before closing the canopy. Turn on the fan to circulate air in the cockpit.

STARTING THE ENGINE

Normal starting procedures are used in hot weather.

TAXI

Taxi carefully with low power to prevent blowing dust on ground personnel and equipment. Braking should be kept at a minimum, although brake overheating is not normally a problem in the U-2.

BEFORE TAKEOFF

Normal procedure is used.

TAKEOFF

The U-2 will takeoff quickly under any

temperature condition, although there is a marked increase in takeoff roll in hot weather as compared to cold weather. Check takeoff distance in Appendix I. Be prepared for thermal turbulence after takeoff.

AFTER TAKEOFF - CLIMB

After takeoff, the normal climb schedule will be followed. The gust control should be placed in the GUST position to prevent excessive loads on the aircraft if thermal turbulence is encountered.

CRUISE

Hot weather has no critical effect on normal cruise.

DESCENT

Descent is normal. Expect turbulence at lower altitudes.

LANDING

Use a normal landing technique, but expect the thermals to cause the aircraft to wallow on approach. Avoid steep angles of bank as thermal turbulence could suddenly increase the angle of bank to a dangerous degree.

AFTER LANDING

Hot weather operation requires the pilot to be cautious of gusts and wind shifts on the ground. Ground roll is slightly longer than normal.

ENGINE SHUT-DOWN

Engine shut-down is normal.

POSTFLIGHT

All ducts and openings should be covered soon after landing to prevent possible dust accumulation.

ALPHABETICAL INDEX

Underlined pages denote pictures or drawings.

A

- A-1, A-2, & B Configurations 4-31
- Acceleration 6-6
 - limitations 5-9
- AFSWP Nose System 4-44
- After Start Engine Check 2-17
- Aileron Control System 1-23
- Aileron Control Characteristics 6-2
- Air Conditioning and Pressurization System 4-3
 - malfunctions 3-26
 - system operation 7-5
- Aircraft, The 1-3
- Aircraft Radio Corp. Type 12 V. H. F. Transceiver 4-14
- Airspeed Indicator 1-27
- Airspeed Limitations 5-5
- Air Start 3-7
- All Weather Operation (see SECTION IX)
- Alternator 1-19
 - malfunction 3-25
- Altimeters 1-27
- AN/ARA-26 Keyer 4-15
- AN/ARC-34 U. H. F. Transceiver 4-13
- AN/ARN-6 Radio Compass 4-16
- AN/ARN-44 Radio Compass 4-16
- AN/ASN-6 Latitude and Longitude Computer 4-59
- Anti-Collision Lights 4-17
- Approach
 - initial 2-23
 - final 2-38
 - missed 9-5
 - ground controlled (G. C. A.) 9-5
- Approach Characteristics 6-10
- APQ-56 Radar Mapping Equipment 4-49
 - flight limitations 6-12
- Attitude Indicator, Type J-8 1-28
- Automatic Observer
 - F-2 foil system 4-40
 - AFSWP nose system 4-44
- Autopilot System 4-65
 - system operation 7-3
- Autopilot Troubleshooting Chart 4-71, 72

B

- Bailout 3-18
- Battery 1-19
- Before Exterior Inspection 2-2
- Before Landing (see Landing)
- Boost Pump 1-17
- Brakes 1-25
 - operation 7-4

C

- C-823/AIC-10 Interphone 4-12
- Camera Configurations (see Photographic equipment)
- Camera Window Covers 4-29
- Camera Window Heaters 4-31
- Canopy 1-30
 - emergency release 3-18
 - pressure seal system 4-5
- CAUTION Definition ii
- Check Lists in Aircraft 4-73
- Checks
 - preliminary cockpit check 2-4
 - exterior inspection 2-5
 - prior to boarding aircraft check 2-8
 - pilot equipment check, low flight 2-9
 - pilot equipment check, high flight 2-10
 - pilot's cockpit check 2-11
 - after start check 2-17
 - before taxiing check 2-18
 - before take-off check 2-19
 - climb check 2-25
 - descent check 2-33
 - 5000 foot check (descending) 2-34
 - before landing check 2-37
 - after landing check 2-45
 - after parking check 2-45
- Climb 2-25
 - characteristics 6-9
 - instrument climb 9-2
- Clocks 1-30
- Cockpit
 - arrangement 1-29
 - lighting 4-17

- Cold Weather Operation 9-8
- Communication Equipment 4-12
 - failure 3-27
- Compass
 - MA-1 4-62
 - MA-1 operation 7-6
 - standby compass 1-28
- Compressor Bleed Valve 1-13
 - malfunction 3-5
- Compressor Stall 7-2
- Condensed Check Lists
 - normal procedures 2-47 thru 2-62
 - emergency procedures 3-29 thru 3-41
- Console, Left Side 1-9
- Console, Right Side 1-11
- Control System, Flight 1-21
- Cross Transfer Pump 1-15
- Crosswind Landings (see Landings)
- Cruise Climb 2-26
 - flight characteristics 6-9
 - on instruments 9-3

D

- Definitions
 - WARNING ii
 - CAUTION ii
 - NOTE ii
- Defrost System, Windshield and Canopy 4-7
- Descent 2-31
 - characteristics 6-9
 - on instruments 9-3
 - emergency 3-15
- Desert Operation 9-8
- Destructor 4-55
- Dimensions, Basic 1-3
- Directional Indicator 1-28
- Downwind Leg 2-37
- Drag Chute 1-27
 - landing 2-41
- Driftsight System 4-19

E

- Ejection Seat 1-31, 1-32
- Electrical System 1-19
 - malfunction 3-23
- Electronic Intelligence Systems 4-39
- Elevator Control System 1-23
 - characteristics 6-2
- Emergency Procedures (see SECTION III)

- Engine 1-3, 1-4
 - fuel system 1-3, 1-6
 - fuel system malfunction 3-8
 - oil system 1-7, 1-8
 - oil system malfunction 3-25
 - ignition system 1-7
 - starter system 1-7
 - instruments 1-12, 1-13
 - starting 2-16
 - climb operation 2-25
 - limitations 5-2
 - operation 7-2
 - failure 3-2
 - vibration 3-5
- Exhaust Gas Temperature (E. G. T.) Indicator 1-13
- Exterior Inspection 2-5

F

- F-2 Foil System 4-40
- Face Plate Heat Malfunction 3-27
- Fire Warning System 1-30
 - operation 3-16
- Flameout Landing Procedure 3-9
- Flap Position Indicator 1-24
- Flight Characteristics (see SECTION VI)
- Flight Plan 2-2
- Fog (or Smoke) in Cockpit 3-17
- Formation Flying 6-12
- Fuel
 - consumption 2-29
 - limitations 5-9
- Fuel Pressure Indicator 1-13
- Fuel System
 - engine 1-3
 - airplane 1-15
 - malfunction (engine) 3-8
 - malfunction (airplane) 3-21
 - operation 7-3
- Fuel Transfer 1-15
 - autopilot trimming 4-67
 - flight characteristics 6-6

G

- Gear Warning Horn 1-25, 1-30
- Generator 1-19
 - malfunction 3-24
- Go-Around 2-43
 - characteristics 6-11
- Gross Weights 1-3

Ground Controlled Approach 9-5
 Gust Control 1-23
 characteristics 6-8
 limitations 5-5
 malfunctions 3-25

H

Hatch Seal 4-5
 Heat Exchanger, Fuel-Oil 1-17
 Hot Weather Operation 9-8
 Hydraulic Pressure Gage 1-21
 Hydraulic System 1-21
 emergency operation 3-21

I

Identification Friend or Foe (IFF) 4-16
 Ignition System 1-7
 Inspection
 before exterior 2-2
 exterior 2-5
 preflight 2-4
 Instrument Flight Procedures 9-2
 Instrument Panel, Cockpit 1-10
 Instruments 1-13
 Inverter 1-19
 malfunction 3-24

J

Jet Penetration Procedures 9-3

K

KWM-1 H. F. Transceiver 4-14

L

Landing 2-38
 flameout landing procedure 3-9
 emergencies 3-13
 characteristics 6-10
 Landing Gear 1-24
 emergency extension 3-21
 Landing Lights 4-17
 Landing Pattern 2-36
 Level Off 2-30
 Limitations 5-1
 Loadmeter 1-19
 malfunctions 3-23

M

MA-1 Compass System 4-62
 operation 7-6
 Magnetic Standby Compass 1-28
 Maneuvers 6-5
 limitations 5-5
 Map Case 4-73
 Missed Approach 9-5

N

Navigation Lights (see Anticollision Lights)
 Night Flying 9-8
 Non-Ejection Seat 1-31
 Normal Procedures (see SECTION II)
 NOTE Definition ii

O

Oil Pressure Indicator 1-15
 Oil System 1-7, 1-8
 malfunction 3-25
 Operating Limitations (see SECTION V)
 Oxygen Consumption Chart 2-29
 Oxygen System 4-7
 malfunctions 3-20

P

P-2 Platform System 4-45
 Personal Equipment 4-9
 Photographic Equipment 4-31
 Pilot Comfort 2-30
 desert operation 9-8
 Pilot's Cockpit Check 2-11
 Pilot's Equipment Checks 2-8
 Pilot's Seat 1-31
 Pitot Heat 4-73
 Pogos 1-25
 flight characteristics 6-12
 Porpoising 6-8
 Power Applications 6-6
 Preflight Inspection 2-4
 Preflight Instrument Procedure 9-2
 Preliminary Cockpit Check 2-4
 Pressurization Schedule 4-4
 Pressure Ratio (P. R.) Indicator 1-13
 Pressure Seal 1-30
 Pressurization System (See Air
 Condition & Pressurization System)

Prior to Boarding Aircraft 2-8

R

Radar Doppler Automatic Navigation
 System (Radan) 4-56
 Rate Meter 4-45
 Rear View Mirrors 4-73
 Relief Tube 4-73
 Rolling Maneuvers 6-5
 on instruments 9-3
 Rubber Cone 4-27, 4-73
 Rudder Control System 1-23
 characteristics 6-2

S

Seat Pack 4-10
 Seat, Pilot's 1-31
 Security Information i
 Sextant 4-24
 Slipper Tank Installation 1-15
 characteristics 6-12
 limitations 5-9
 Smoke (or Fog) in Cockpit 3-17
 Speed Brakes 1-24
 characteristics 6-8
 Speed Warning System 1-30
 Spins 6-7
 Stability 6-2
 Stalls 6-5
 Start Engine Check 2-16
 Starter System 1-7
 Status of the Airplane 2-2
 Steering System 1-25
 Sump Tank 1-15
 overflow warning light 1-17
 Sunshade 1-31, 4-74
 Survival Gear 4-11
 Systems I, III, & IV 4-39
 Systems Operation (see SECTION VII)

T

Table of Contents iii
 Tachometer 1-13
 Take-off 2-20
 characteristics 6-9
 on instruments 9-2
 Taxiing 2-18
 instrument procedures 9-2
 Taxi Lights 4-17
 Throttle 1-5

Thunderstorms 9-7
 Tire Skidding 7-5
 Tracker Camera 4-31, 4-32
 Trim Control Characteristics 6-2
 Trim Control, Lateral 2-24
 characteristics 6-5
 Trim, Lateral-Directional Check 7-6
 Trim Tab Malfunction 3-25
 Turbulence 2-24, 9-7
 Turn and Slip Indicator 1-28

V

Valve, Fuel Shut-off 1-17
 Vent System, Fuel Tank 1-19
 Vertical Speed Indicator 1-27

W

WARNING Definition ii
 Warning Horn, Gear 1-30
 Warning Lights
 A-C alternator out 1-21
 compressor bleed valve open 1-13
 fire or overheat 1-30
 fuel low level 1-17
 generator out 1-19
 inverter out 1-19
 sump tank overflow 1-17
 Weather Survey Equipment 4-54
 Weight and Balance 2-2
 limitations 5-9
 Window Covers, Camera 4-29
 Window Heaters, Camera 4-31
 Windshield Swab 4-74
 Wing Flaps 1-23
 malfunction 3-26

Y

Yaw, Adverse 6-5

